









American Sign Language (ASL) Dictionary

Unedited 08082023

Spoken Word	SignWriting
!	
(sit) criss cross	
,	
,	=
-ance	
.	
.	-
0 for grade	
1	
1	
1	
1	

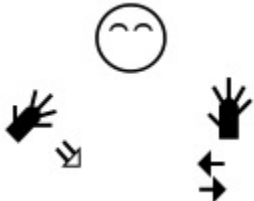



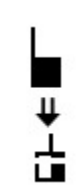
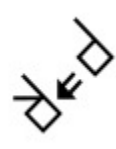
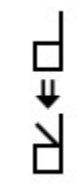
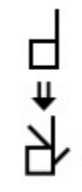
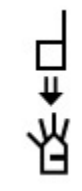

American Sign Language (ASL) Dictionary

Unedited 08082023

Spoken Word	SignWriting
1,000,000	
1-year	
1/10	
1/2	
1/2	
1/3	
1/4	



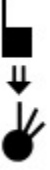





American Sign Language (ASL) Dictionary

Unedited 08082023

Spoken Word	SignWriting
1/5	
1/6	
1/7	
1/8	
1/9	
10	
10	













American Sign Language (ASL) Dictionary

Unedited 08082023

Spoken Word	SignWriting
10	
100	
100	
100	
100	
100	
1000	
1000	
1000	











American Sign Language (ASL) Dictionary

Unedited 08082023

Spoken Word	SignWriting
101	
101	
102	
102	
102	
103	
103	
103	
104	
104	
105	
105	
106	









American Sign Language (ASL) Dictionary

Unedited 08082023

Spoken Word	SignWriting
106	
107	
107	
108	
108	
109	
109	
10th	
10th	
10th (in a series) (left hand)	
10th (in a series) (right hand)	



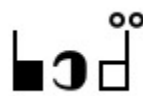







American Sign Language (ASL) Dictionary

Unedited 08082023

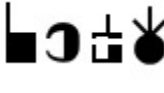
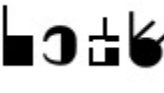
Spoken Word	SignWriting
11	
11	
11	
11	
110	
110	
110	
111	
111	
111	

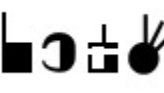





American Sign Language (ASL) Dictionary

Unedited 08082023

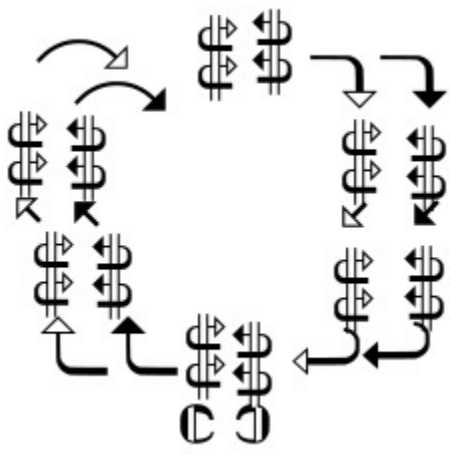
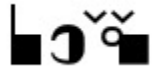
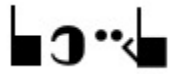
Spoken Word	SignWriting
112	
113	
114	
115	
116	
117	
118	
119	
12	
12	
12	











American Sign Language (ASL) Dictionary

Unedited 08082023

Spoken Word	SignWriting
12	
12 classes	
120	
121	
122	
123	
123 sort	
124	
125	













American Sign Language (ASL) Dictionary

Unedited 08082023

Spoken Word	SignWriting
126	
127	
128	
129	
13	
13	
130	
131	
132	
133	
134	













American Sign Language (ASL) Dictionary

Unedited 08082023

Spoken Word	SignWriting
135	
136	
137	
138	
139	
14	
14	
14	
14	
14	
14	
140	
141	











American Sign Language (ASL) Dictionary

Unedited 08082023

Spoken Word	SignWriting
142	
143	
144	
145	
146	
147	
148	
149	
15	
15	
15	
150	



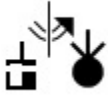
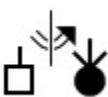







American Sign Language (ASL) Dictionary

Unedited 08082023

Spoken Word	SignWriting
151	
152	
153	
154	
155	
156	
157	
158	
159	
16	
16	
16	





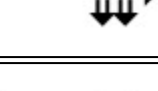







American Sign Language (ASL) Dictionary

Unedited 08082023

Spoken Word	SignWriting
16	
16	
16	
16	
160	
161	
162	
163	
164	
165	
166	
167	

American Sign Language (ASL) Dictionary

Unedited 08082023

Spoken Word	SignWriting
168	
169	
17	
17	
17	
17	
17	
170	
171	
172	
173	
174	









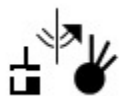

American Sign Language (ASL) Dictionary

Unedited 08082023

Spoken Word	SignWriting
175	
176	
177	
178	
179	
18	
18	
18	
18	
18	
180	
181	













American Sign Language (ASL) Dictionary

Unedited 08082023

Spoken Word	SignWriting
181	
181	
19	
19	
19	
19	
19	
1969	
1974	
1984	
1989	



American Sign Language (ASL) Dictionary

Unedited 08082023

Spoken Word	SignWriting
1989	
1990	
1990	
1991	
1991	
1992	
1993	
1994	
1995	
1996	
1997	
1998	



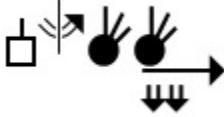
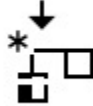







American Sign Language (ASL) Dictionary

Unedited 08082023

Spoken Word	SignWriting
1999	
1st	
1st	
1st (in a list)	
1st sentence	





American Sign Language (ASL) Dictionary

Unedited 08082023

Spoken Word	SignWriting
1st, first	
2	
2	
2,000,000	
20	
20	
200	
200	
200	
2000	



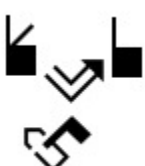
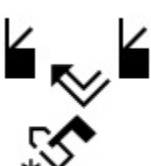
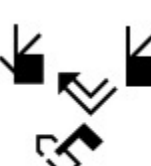





American Sign Language (ASL) Dictionary

Unedited 08082023

Spoken Word	SignWriting
2000	
2000	
2001	
2001	
2002	
2003	
2004	





American Sign Language (ASL) Dictionary

Unedited 08082023

Spoken Word	SignWriting
2005	
2006	
2006	
2006	
2007	
2007	
2008	
2012	

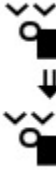
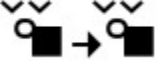

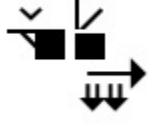
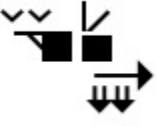
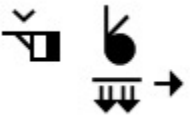







American Sign Language (ASL) Dictionary

Unedited 08082023

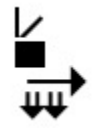
Spoken Word	SignWriting
2014	
2020	
2020	
2020	
2022	
2022	
2022	
2023	









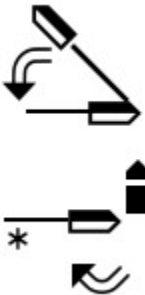

American Sign Language (ASL) Dictionary

Unedited 08082023

Spoken Word	SignWriting
2023	
2023	
21	
21	
210	
22	
22	
22	
23	
23	
23	
24	











American Sign Language (ASL) Dictionary

Unedited 08082023

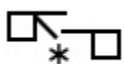
Spoken Word	SignWriting
24	
24	
24-hours	
25	
25	
25	
25	
25	
26	
26	
27	

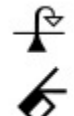





American Sign Language (ASL) Dictionary

Unedited 08082023

Spoken Word	SignWriting
27	
28	
28	
29	
29	
2nd	
2nd	
2nd (left hand)	
3	
3	
3 o'clock	



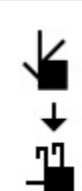
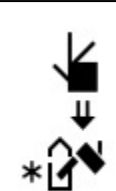

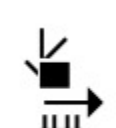



American Sign Language (ASL) Dictionary

Unedited 08082023

Spoken Word	SignWriting
3,000,000	
30	
30	
300	
300	
300	
3000	
31	
32	
33	





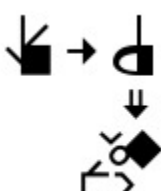
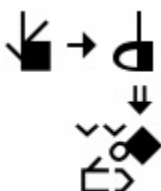

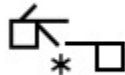

American Sign Language (ASL) Dictionary

Unedited 08082023

Spoken Word	SignWriting
33	
34	
35	
36	
37	
38	
39	
3D	
3d-print	
3d-printer	



American Sign Language (ASL) Dictionary

Unedited 08082023

Spoken Word	SignWriting
3rd	
3rd	
3rd (ranking)	
4	
4	
4 o'clock	
4 years old	
4 years old	
4,000,000	





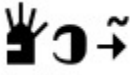



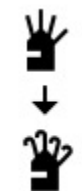

American Sign Language (ASL) Dictionary

Unedited 08082023

Spoken Word	SignWriting
40	
40	
400	
400	











American Sign Language (ASL) Dictionary

Unedited 08082023

Spoken Word	SignWriting
400	
4000	
41	
42	
43	
44	
44	
45	
46	
47	











American Sign Language (ASL) Dictionary

Unedited 08082023

Spoken Word	SignWriting
48	
49	
49	
4th	
4th	
4th (left hand)	
5	
5	
5 o'clock	
5,000,000	









American Sign Language (ASL) Dictionary

Unedited 08082023

Spoken Word	SignWriting
50	
50	
50	
500	
500	
5000	
51	
52	
53	
54	



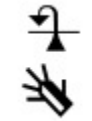
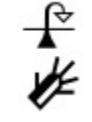

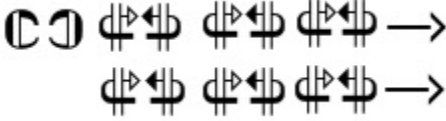

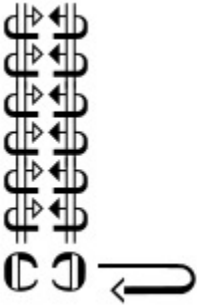

American Sign Language (ASL) Dictionary

Unedited 08082023

Spoken Word	SignWriting
55	
55	
56	
57	
58	
59	
5th	
5th	
5th (left hand)	
6	
6 classes	

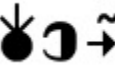

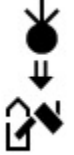







American Sign Language (ASL) Dictionary

Unedited 08082023

Spoken Word	SignWriting
6 classes	
6 o'clock	
6,000,000	
60	
600	
600	
6000	
61	





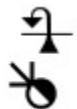

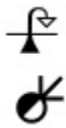
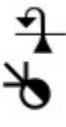

American Sign Language (ASL) Dictionary

Unedited 08082023

Spoken Word	SignWriting
61	
62	
63	
64	
65	
66	
66	
67	
68	
69	
6th	

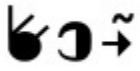
American Sign Language (ASL) Dictionary

Unedited 08082023

Spoken Word	SignWriting
6th (left hand)	
6th (Rank)	
7	
7 o'clock	
7,000,000	
70	
700	
700	
7000	
71	







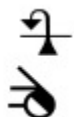

American Sign Language (ASL) Dictionary

Unedited 08082023

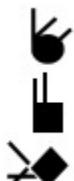
Spoken Word	SignWriting
72	
73	
74	
74	
75	
75	
76	
77	
77	
78	
79	
7th	



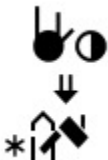





American Sign Language (ASL) Dictionary

Unedited 08082023

Spoken Word	SignWriting
7th	
7th	
7up	
8	
8 o'clock	
8,000,000	
80	
80,000	
800	









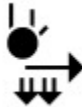

American Sign Language (ASL) Dictionary

Unedited 08082023

Spoken Word	SignWriting
800	
8000	
81	
82	
83	
84	
85	
86	
87	









American Sign Language (ASL) Dictionary

Unedited 08082023

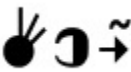
Spoken Word	SignWriting
88	
88	
89	
8th	
8th	
8th	
8th (in a series)	 
8th (in a series)	 
9	











American Sign Language (ASL) Dictionary

Unedited 08082023

Spoken Word	SignWriting
9 o'clock	
9,000,000	
90	
900	
900	
9000	
91	
92	
93	
94	

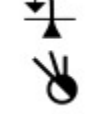
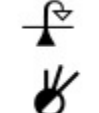







American Sign Language (ASL) Dictionary

Unedited 08082023

Spoken Word	SignWriting
95	
96	
97	
98	
99	
99	
9th	
9th	
9th	
9th (in a series)	
:	





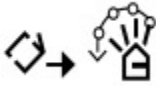
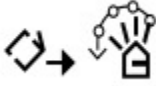



American Sign Language (ASL) Dictionary

Unedited 08082023

Spoken Word	SignWriting
;-)	
?	
?	=
@ symbol	
A	
A	
a dress	
a dress	
a few	
a few	
a few days in the future	
a little while ago	

American Sign Language (ASL) Dictionary

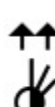
Unedited 08082023

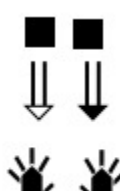
Spoken Word	SignWriting
a little while ago	
a lot	
a lot	
a lot	
a second	
a second	
a-ok	
abandon	
abandon	





American Sign Language (ASL) Dictionary

Unedited 08082023

Spoken Word	SignWriting
abandon	
abandon	
abandon	
ABANDON	
abbreviate	
abbreviate	
abbreviate	
abbreviate	
abbreviate	

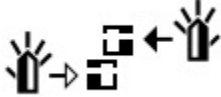

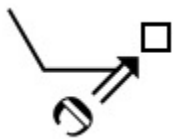
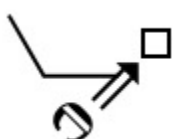
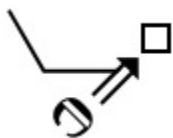
American Sign Language (ASL) Dictionary

Unedited 08082023

Spoken Word	SignWriting
abbreviate	
abdoman	
abdomen	
abduct	
abduct	
abduction	
ability	
ability	



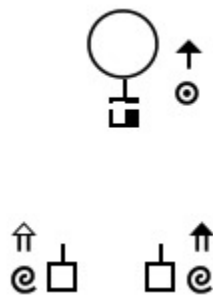
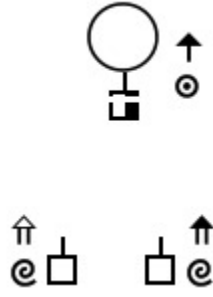
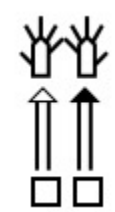
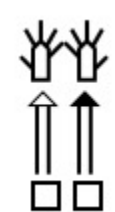

American Sign Language (ASL) Dictionary

Unedited 08082023

Spoken Word	SignWriting
Abiotic	
Abiotic	
ablaze	
ablaze	
able	
able	

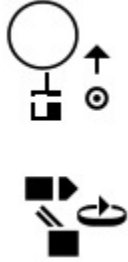
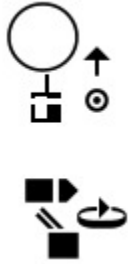
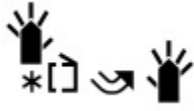
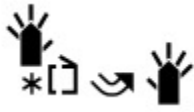
American Sign Language (ASL) Dictionary

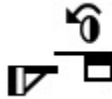
Unedited 08082023

Spoken Word	SignWriting
abnormal	
abnormal	
abort	
abortion	
abortion	
about	
about	







American Sign Language (ASL) Dictionary

Unedited 08082023

Spoken Word	SignWriting
about	
about	
about	
about	
about	
about time	
about time	
above	



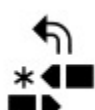
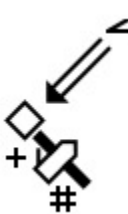
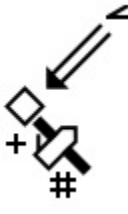

American Sign Language (ASL) Dictionary

Unedited 08082023

Spoken Word	SignWriting
above	
above	
above	
above	
above	
Abraham	
Abraham	
abrupt	

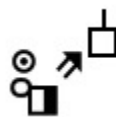



American Sign Language (ASL) Dictionary

Unedited 08082023

Spoken Word	SignWriting
abrupt	
abscess	
abscess	
absent	





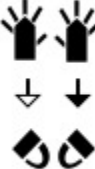
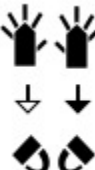



American Sign Language (ASL) Dictionary

Unedited 08082023

Spoken Word	SignWriting
absent	
absent	
absent	
absolute	
absolute	
absorb	
absorb	







American Sign Language (ASL) Dictionary

Unedited 08082023

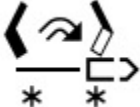
Spoken Word	SignWriting
abstain	
abstain	
abstract	
abstract	
abstract	
abstract	
absurd	
absurd	

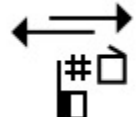
American Sign Language (ASL) Dictionary

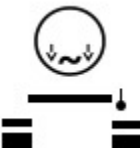
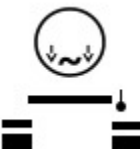
Unedited 08082023

Spoken Word	SignWriting
abundance	
abundance	
abuse	
abuse	
academic	
accelerate motorcycle	
accelerate motorcycle	
accelerate motorcycle intensely	









American Sign Language (ASL) Dictionary

Unedited 08082023

Spoken Word	SignWriting
accelerate motorcycle intensely	
accept	
accept	
accept	
accept	
accept	
acceptanc	







American Sign Language (ASL) Dictionary

Unedited 08082023

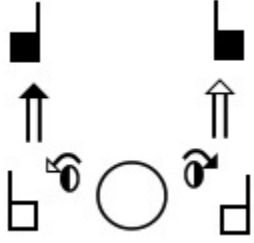
Spoken Word	SignWriting
accessible	
accessible	
accident	
accident	
accident	
acclaim	
acclaim	
acclimation	
acclimation	

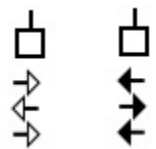
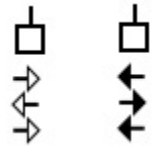

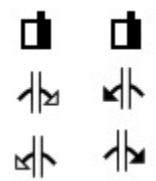



American Sign Language (ASL) Dictionary

Unedited 08082023

Spoken Word	SignWriting
accompany	
accomplish	
accomplishment	
accordion	
accordion	
according to	
accordion	
account	

American Sign Language (ASL) Dictionary

Unedited 08082023

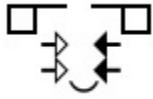
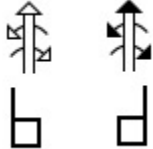
Spoken Word	SignWriting
account	
accountant	
accredit	
accumulate	
accuse	
accustomed to	
ace	
ache	
achieve	





American Sign Language (ASL) Dictionary

Unedited 08082023

Spoken Word	SignWriting
acid	
acostumbrar	
acquaint	
acquiesce	
acrobat	
across	
across	
act of a play	
act on stage	

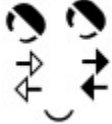

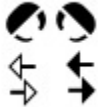
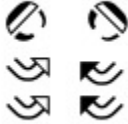



American Sign Language (ASL) Dictionary

Unedited 08082023

Spoken Word	SignWriting
act slowly	
action	
action	
action	
active	
activity	
actor	



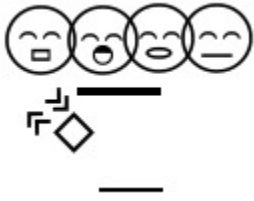





American Sign Language (ASL) Dictionary

Unedited 08082023

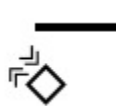
Spoken Word	SignWriting
actor	
Acts	
actually	
Adam	
Adam	
Adam	

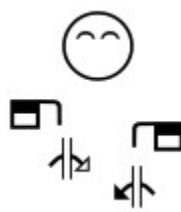
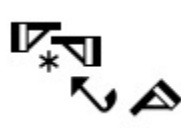





American Sign Language (ASL) Dictionary

Unedited 08082023

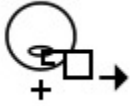
Spoken Word	SignWriting
Adam	
Adam Frost	
Adam Frost	
Adam Frost	
Adamorobe	
add	
add	
add onto	
add onto	

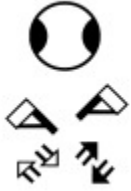
American Sign Language (ASL) Dictionary

Unedited 08082023

Spoken Word	SignWriting
add up	
addicted	
addiction	
adding	
addition	
Addition	
address (location)	
address (location)	





American Sign Language (ASL) Dictionary

Unedited 08082023

Spoken Word	SignWriting
adhesive	<p>The SignWriting for 'adhesive' consists of a circle with a horizontal line through its center, representing the mouth. Below this is a hand symbol with fingers spread, a curved arrow pointing to the right, and a small square with a circle inside, representing the letter 'A'.</p>
adjective	<p>The SignWriting for 'adjective' features a hand symbol with fingers spread, a solid black circle, and a hand symbol with fingers spread and a curved arrow pointing upwards and to the right.</p>
adjective	<p>The SignWriting for 'adjective' includes a hand symbol with fingers spread, a solid black circle, and a hand symbol with fingers spread and a curved arrow pointing upwards and to the right.</p>
administration	<p>The SignWriting for 'administration' shows a hand symbol with fingers spread, a solid black circle, a wavy arrow pointing upwards, and a hand symbol with fingers spread.</p>
administrative assistant	<p>The SignWriting for 'administrative assistant' includes a circle with an asterisk above it, a hand symbol with fingers spread, a double-lined arrow pointing downwards and to the right, a hand symbol with fingers spread, and a small circle with a dot inside.</p>

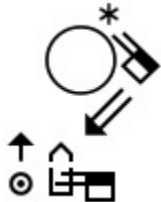

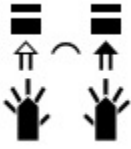
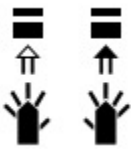
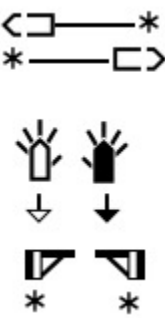





American Sign Language (ASL) Dictionary

Unedited 08082023

Spoken Word	SignWriting
administrative assistant	
administrative assistant	
adolescent	
adopt	
adopt	
adopt	
ADRAR	



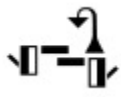
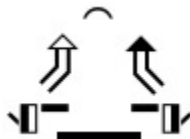

American Sign Language (ASL) Dictionary

Unedited 08082023

Spoken Word	SignWriting
adroit	
adult	
adult	
adult (left hand)	
adult (right hand)	
adultery	
advance	
advanced	
advantage	

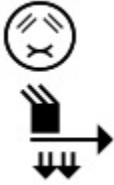
American Sign Language (ASL) Dictionary

Unedited 08082023

Spoken Word	SignWriting
adventure	
adverb mm	
adverb th	
adverbs	
adverbs	
adverbs	







American Sign Language (ASL) Dictionary

Unedited 08082023

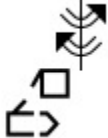
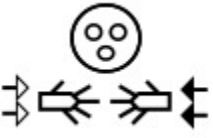
Spoken Word	SignWriting
adverbs	
advertise	
advertise	
advertise	
advice	
advisor	

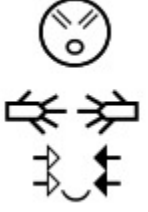
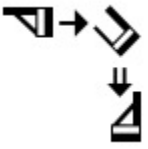







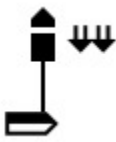

American Sign Language (ASL) Dictionary

Unedited 08082023

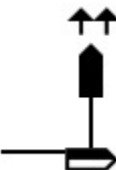
Spoken Word	SignWriting
aerobics	
afraid	
afraid	
afraid	
Africa	
Africa	
Africa	
African	







American Sign Language (ASL) Dictionary

Unedited 08082023

Spoken Word	SignWriting
African	
after	
afternoon	
afternoon	
afternoon	
afternoon	
again	
again	
again	
again	





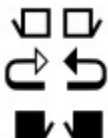



American Sign Language (ASL) Dictionary

Unedited 08082023

Spoken Word	SignWriting
again and again	
again and again	
against	
against	
against	
age	
age	
agency	







American Sign Language (ASL) Dictionary

Unedited 08082023

Spoken Word	SignWriting
agree	
agree	
agriculture	
ahead	
aid	
ail	
Aim	
air	

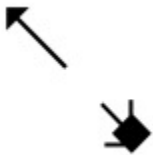





American Sign Language (ASL) Dictionary

Unedited 08082023

Spoken Word	SignWriting
air	
air pressure	
airplane	
Airplane	
airplane departs	
airplane departs	
airplane landing	
airplane landing	





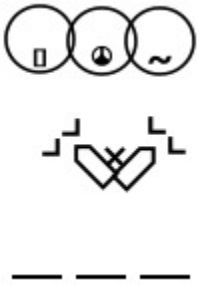
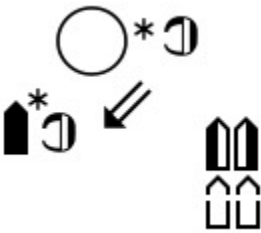



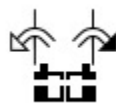

American Sign Language (ASL) Dictionary

Unedited 08082023

Spoken Word	SignWriting
airport	
ajar	
ala	
Alabama	
Alaska	
Alaska	
Albania	
album	







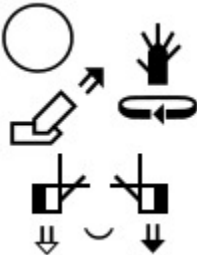

American Sign Language (ASL) Dictionary

Unedited 08082023

Spoken Word	SignWriting
albumn	
Albuquerque	
alcoholic	
alcoholic	
Alert	
Alexis	
algebra	
algebra	
algorithm	
Alice	

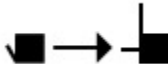

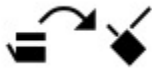
American Sign Language (ASL) Dictionary

Unedited 08082023

Spoken Word	SignWriting
alien	
all	
all	
all	
all	
all	
all	
all	
all (noun)	



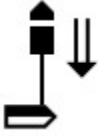





American Sign Language (ASL) Dictionary

Unedited 08082023

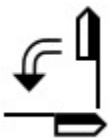
Spoken Word	SignWriting
all afternoon	
all day	
all day	

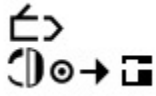







American Sign Language (ASL) Dictionary

Unedited 08082023

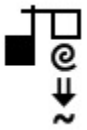
Spoken Word	SignWriting
all day	
all day	
all day	
all day with eyegaze	
all gone	
all gone	
all gone	
all gone	









American Sign Language (ASL) Dictionary

Unedited 08082023

Spoken Word	SignWriting
all gone	
all hour	
all month	
all morning	
all night	
all night	
all night	
all of you	

American Sign Language (ASL) Dictionary

Unedited 08082023

Spoken Word	SignWriting
all of you formal	
all of yours (left hand)	
all of yours (right hand)	
all of yourselves (left)	
all of yourselves (right)	
all over	
all over	
all over	
all over	







American Sign Language (ASL) Dictionary

Unedited 08082023

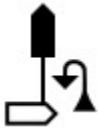
Spoken Word	SignWriting
all over	
all right	
all right	
all right	
all week	
all week	
all week every week	
ALL-ABOUT-MY-HEART	

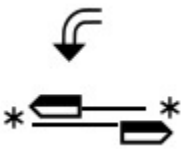

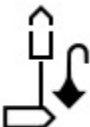
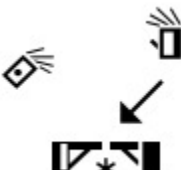

American Sign Language (ASL) Dictionary

Unedited 08082023

Spoken Word	SignWriting
all-afternoon	
all-around	
all-day	
all-evening	
all-morning	
all-together	
allday facial	
allegiance	

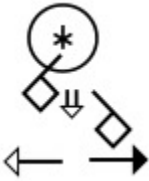
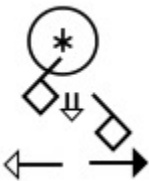
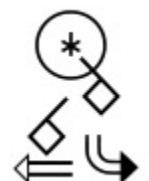
American Sign Language (ASL) Dictionary

Unedited 08082023

Spoken Word	SignWriting
allergies	
allergies	
allergy	
alliance	
alligator	
alligator	
alligator	





American Sign Language (ASL) Dictionary

Unedited 08082023

Spoken Word	SignWriting
alligator	
alligator	
alligator	
alligator	
alligator	
alligator	

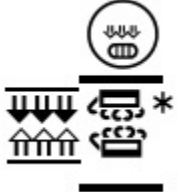

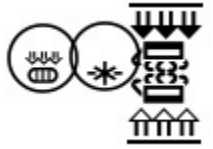

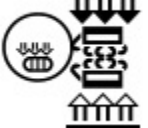
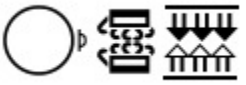
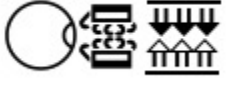
American Sign Language (ASL) Dictionary

Unedited 08082023

Spoken Word	SignWriting
alligator	
alligator	
alligator	
alligator	
alligator	
alligator	
alligator	
alligator	

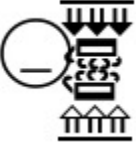
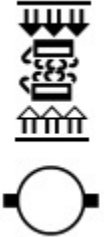
American Sign Language (ASL) Dictionary

Unedited 08082023

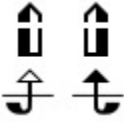
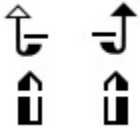
Spoken Word	SignWriting
alligator	
alligator	
alligator	
alligator	
alligator	
allow	
allow	





American Sign Language (ASL) Dictionary

Unedited 08082023

Spoken Word	SignWriting
almost	
almost	
alone	
alone	
alone	
alone	
alone	
alone	
alone	



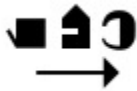

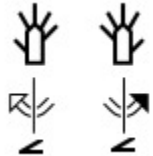
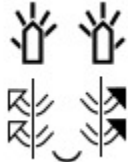
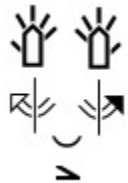

American Sign Language (ASL) Dictionary

Unedited 08082023

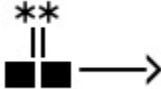
Spoken Word	SignWriting
alone	
alone - left hand	
alphabet	
alphabet	
alphabet	
already	
already	
already	



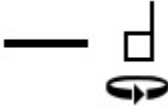

American Sign Language (ASL) Dictionary

Unedited 08082023

Spoken Word	SignWriting
alright	
also	
also	
altar	
alter	
alter	
altitude	
always	
always	

American Sign Language (ASL) Dictionary

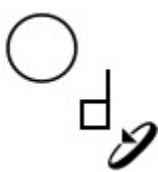
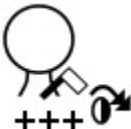
Unedited 08082023

Spoken Word	SignWriting
always	
always	
always	
always	
always-broke	
always-coming-over	









American Sign Language (ASL) Dictionary

Unedited 08082023

Spoken Word	SignWriting
always-go-over	
am	
amaze	
amaze	
amaze	
amazement	
amazement	
amazement	









American Sign Language (ASL) Dictionary

Unedited 08082023

Spoken Word	SignWriting
amazement	
amazement	
amazing	
amazing	
amazing	
amazing	
ambitious	
ambulance	







American Sign Language (ASL) Dictionary

Unedited 08082023

Spoken Word	SignWriting
amen	
amen	
amend	 
amend 2	
amendment	
amendment	
America	

American Sign Language (ASL) Dictionary

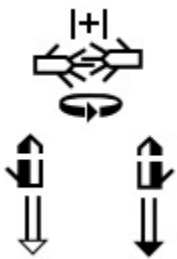
Unedited 08082023

Spoken Word	SignWriting
America	
America	
America	
American	
American	
American	
American Indian	

American Sign Language (ASL) Dictionary

Unedited 08082023

Spoken Word	SignWriting
American Sign	<p>The SignWriting for 'American Sign' consists of three parts: 1) Two hands with index fingers pointing towards each other, palms facing outwards. 2) A circular arrow above the hands, indicating a clockwise rotation. 3) A vertical line with a plus sign below it, representing the letter 'I'.</p>
American Sign Language	<p>The SignWriting for 'American Sign Language' consists of three parts: 1) Two hands with index fingers pointing towards each other, palms facing outwards, with a circular arrow above them. 2) A vertical line with an asterisk below it, representing the letter 'L'. 3) Two hands with index fingers pointing towards each other, palms facing outwards, with a circular arrow above them.</p>
American Sign Language	<p>The SignWriting for 'American Sign Language' consists of three parts: 1) Two hands with index fingers pointing towards each other, palms facing outwards, with a circular arrow above them. 2) A vertical line with an asterisk below it, representing the letter 'L'. 3) Two hands with index fingers pointing towards each other, palms facing outwards, with a circular arrow above them.</p>
American Sign Language	<p>The SignWriting for 'American Sign Language' consists of three parts: 1) Two hands with index fingers pointing towards each other, palms facing outwards, with a circular arrow above them. 2) A vertical line with an asterisk below it, representing the letter 'L'. 3) Two hands with index fingers pointing towards each other, palms facing outwards, with a circular arrow above them.</p>





American Sign Language (ASL) Dictionary

Unedited 08082023

Spoken Word	SignWriting
American Sign Language	<p>The SignWriting for 'American Sign Language' consists of three vertical components. The top component shows two hands with fingers spread, palms facing each other, with a squiggle above them. The middle component shows two hands with fingers spread, palms facing each other, with a triangle and a circle between them. The bottom component shows two hands with fingers spread, palms facing each other, with a horizontal line between them and two curved arrows below.</p>
American Sign Language	<p>The SignWriting for 'American Sign Language' consists of two vertical columns of three components each. The left column is identical to the one in the previous row. The right column shows a vertical line with a square at the top, a horizontal line, and a vertical line with a square at the bottom. Below this is a hand with fingers spread, palm facing left, with a circle and a triangle to its right. The bottom component is a hand with fingers spread, palm facing left, with a squiggle above it.</p>
American Sign Language Alphabet	
American Sign Language Numbers	
among	<p>The SignWriting for 'among' shows a hand with fingers spread, palm facing left, with a squiggle above it and a vertical line with a square at the top to its right.</p>
amount	<p>The SignWriting for 'amount' shows a hand with fingers spread, palm facing left, with a squiggle above it and a vertical line with a square at the top to its right.</p>

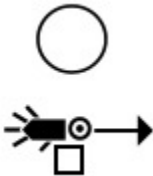
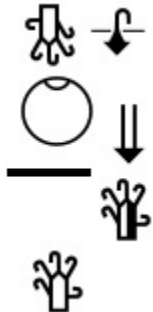

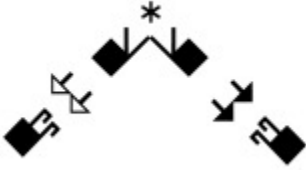

American Sign Language (ASL) Dictionary

Unedited 08082023

Spoken Word	SignWriting
amount	
ample	
An Tir	
analyze	
analyze	
analyze	
analyze	

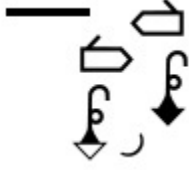
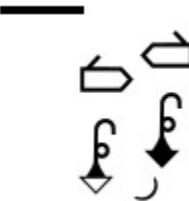

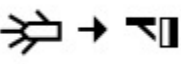

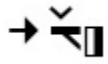
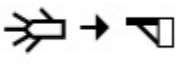
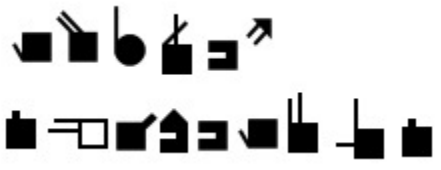
American Sign Language (ASL) Dictionary

Unedited 08082023

Spoken Word	SignWriting
ancestors	
ancestors	
ancient	
and	
and	
and	
and	
and	
andre	

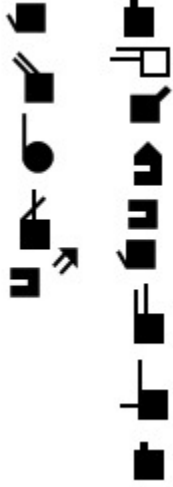





American Sign Language (ASL) Dictionary

Unedited 08082023

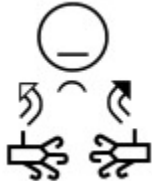
Spoken Word	SignWriting
andre	
andre	
Andre	
Andrew	
angel	

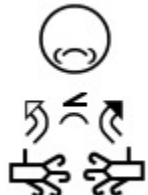

American Sign Language (ASL) Dictionary

Unedited 08082023

Spoken Word	SignWriting
angels	
anger	
anger-simmer	
angle	
angry	
angry	
angry	



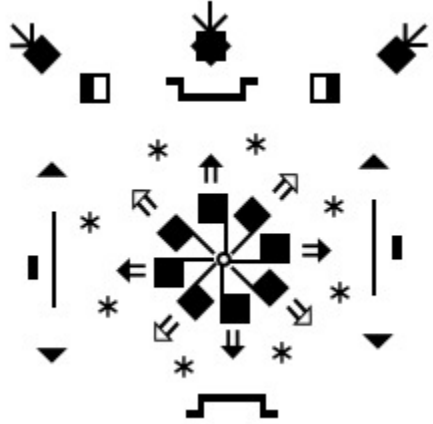
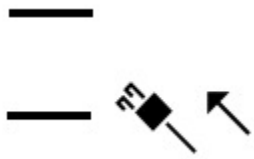
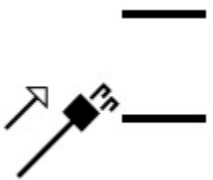

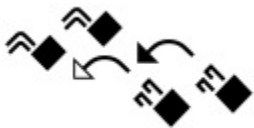
American Sign Language (ASL) Dictionary

Unedited 08082023

Spoken Word	SignWriting
animal	
animal	
animal approaching	
animal approaching	
animal hopping left to right	
animal jumping	

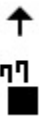

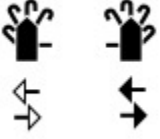



American Sign Language (ASL) Dictionary

Unedited 08082023

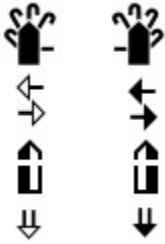
Spoken Word	SignWriting
animal jumps on me	
animal moves forward	
animal sitting	
animal-licks-face	
animate	
ANIMATION	
Animation 1	
Animation 2	
Animation 3	



American Sign Language (ASL) Dictionary

Unedited 08082023

Spoken Word	SignWriting
animator	
AnnaGrace	
annex	
anniversary	
annoy	
annoy	

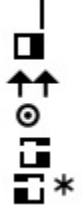
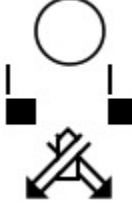
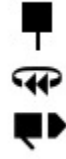
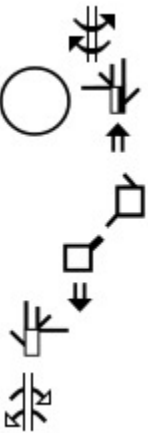

American Sign Language (ASL) Dictionary

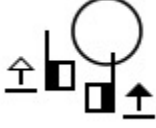
Unedited 08082023

Spoken Word	SignWriting
annually	
annul	
anoint	
anorexia	
another	
answer	



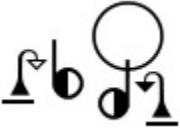
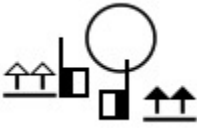
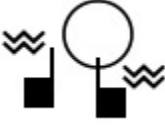



American Sign Language (ASL) Dictionary

Unedited 08082023

Spoken Word	SignWriting
answer	
answer	
answer	
ant	
ant	

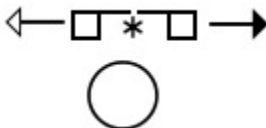

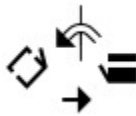
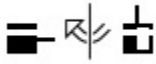
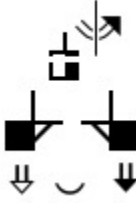

American Sign Language (ASL) Dictionary

Unedited 08082023

Spoken Word	SignWriting
antenna	
antlers	
Antonym	
anxious	
any	
any	
any	
any (left hand)	
anyone	

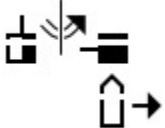

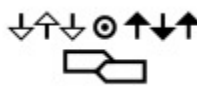

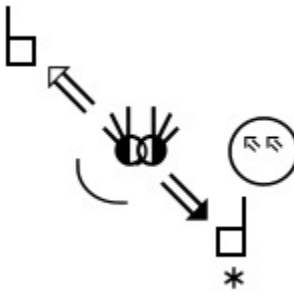
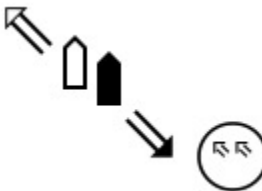

American Sign Language (ASL) Dictionary

Unedited 08082023

Spoken Word	SignWriting
anything	
anyway	
anyway	
anyway	
apart	
apart	
apart	
apart	

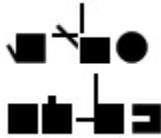
American Sign Language (ASL) Dictionary

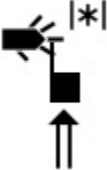
Unedited 08082023

Spoken Word	SignWriting
apartment	
apathy	
apologize	
apostle	
App	
App	
appear	
appear	









American Sign Language (ASL) Dictionary

Unedited 08082023

Spoken Word	SignWriting
appear	
appear	
appearance	
appease	
appetite	
applaud	
applause	
applause	
applause	



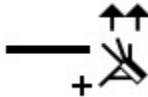





American Sign Language (ASL) Dictionary

Unedited 08082023

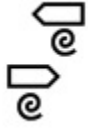
Spoken Word	SignWriting
applause	
applause	
applause	
applause	
apple	
apple	
apply	
apply	
apply	



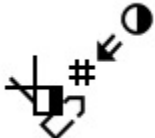



American Sign Language (ASL) Dictionary

Unedited 08082023

Spoken Word	SignWriting
appoint	
appointment	
appreciate	
appreciate	
approach	
appropriate	
approve	
April	



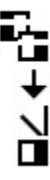



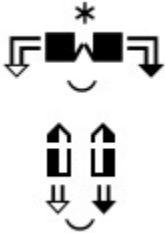

American Sign Language (ASL) Dictionary

Unedited 08082023

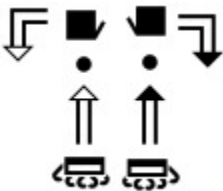
Spoken Word	SignWriting
April	
April 16, 2008	
apron	
Arabic	
Arabic (language)	
arch	
archery	
archery	

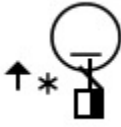

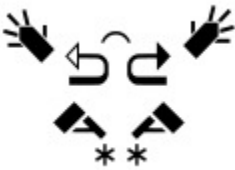



American Sign Language (ASL) Dictionary

Unedited 08082023

Spoken Word	SignWriting
architect	
architect	
architecture	
architecture	
are	
are	
area	
area	



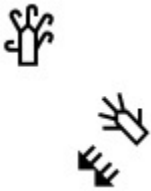
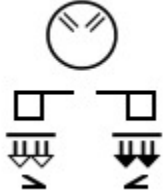



American Sign Language (ASL) Dictionary

Unedited 08082023

Spoken Word	SignWriting
area	
area (front)	
area (left)	
area (right)	
Argentina	
Argentina	
argue	
argue	

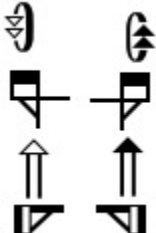

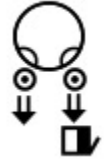



American Sign Language (ASL) Dictionary

Unedited 08082023

Spoken Word	SignWriting
argue	
argue	
arise	
aristocracy	
arithmetic	
Arizona	
Arizona	
arkansas	

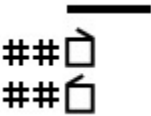
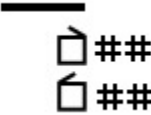





American Sign Language (ASL) Dictionary

Unedited 08082023

Spoken Word	SignWriting
Arkansas	
arm	
armadillo	
army	
army	
aroma	
aroma	
around	
around	



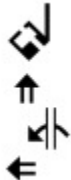

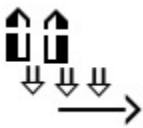

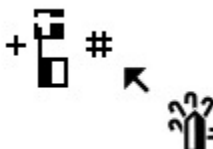
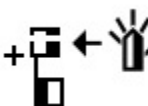

American Sign Language (ASL) Dictionary

Unedited 08082023

Spoken Word	SignWriting
around	
around	
around	
around and around	
around and around	
around the corner	
arrange	
arrange	





American Sign Language (ASL) Dictionary

Unedited 08082023

Spoken Word	SignWriting
arrest	
arrest	
arrest	
arrive	
arrive	
arrive	
arrive	
arrive	
arrogant	

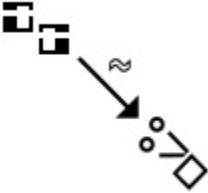

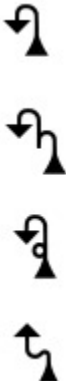



American Sign Language (ASL) Dictionary

Unedited 08082023

Spoken Word	SignWriting
arrow	
arrow forward	
arrows test	
ARROWS TEST 2	
art	





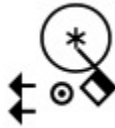

American Sign Language (ASL) Dictionary

Unedited 08082023

Spoken Word	SignWriting
art	
art	
article	
article	
article	
article	
article	
artificial	





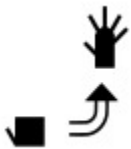

American Sign Language (ASL) Dictionary

Unedited 08082023

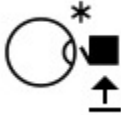
Spoken Word	SignWriting
artist	
artist	
Arturo	
as	
ashamed	
ashamed	
ashamed	
Asia	

American Sign Language (ASL) Dictionary

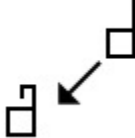
Unedited 08082023

Spoken Word	SignWriting
Asian	
Asian	
ask	
ask	
ask (v) he she asks me	
ask (v) I ask you	
ask (v) questioning me	







American Sign Language (ASL) Dictionary

Unedited 08082023

Spoken Word	SignWriting
ask (v) questioning me	<p>The signwriting consists of a circle with an upward arrow above it, followed by a series of symbols including a triangle, a curved line, and two vertical bars with dots, representing the ASL sign for 'ask'.</p>
ask (v) to ask a question	<p>The signwriting consists of a vertical line, a solid black square, an upward arrow, and another solid black square.</p>
ask (v) you ask me	<p>The signwriting consists of a vertical line, a square, a downward arrow, and another square.</p>
ask (v) you ask me (left)	<p>The signwriting consists of a vertical line, a square, a downward arrow, and another square, with a small horizontal line extending to the left from the top square.</p>
ask a question	<p>The signwriting consists of a square, a downward arrow, and another square.</p>
ask everyone	<p>The signwriting consists of two vertical lines, each with a square at the top and a diamond at the bottom, with various symbols in between representing the ASL sign for 'ask everyone'.</p>

American Sign Language (ASL) Dictionary

Unedited 08082023

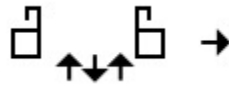
Spoken Word	SignWriting
ask everyonn	
ask me	
ask you	
ASL	
ASL	
asl-sem-prag-pd 29	
asl-sem-prag-pd 42	
asl-sem-prag-pd 45	





American Sign Language (ASL) Dictionary

Unedited 08082023

Spoken Word	SignWriting
asleep	
asleep soundly	
assemble	
assembly	
asshole	
assignment	
assistant	
assistant	

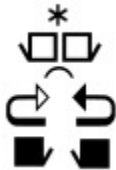



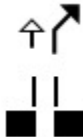

American Sign Language (ASL) Dictionary

Unedited 08082023

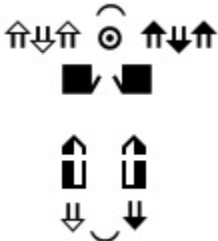
Spoken Word	SignWriting
assistant	
association	
association	
Assure	
Assyria	
asthma	
astray	







American Sign Language (ASL) Dictionary

Unedited 08082023

Spoken Word	SignWriting
astray	
astrologer	
astrologer	
astrology	
astronaut	
at	
at	
at	



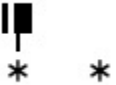
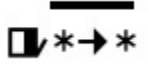
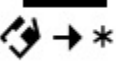

American Sign Language (ASL) Dictionary

Unedited 08082023

Spoken Word	SignWriting
at	
at least	
at symbol	
atherosclerosis	
Atlanta, GA	
Atlanta, Georgia	
Atlanta, Georgia	
atlantic ocean	
ATM	

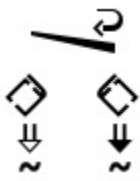
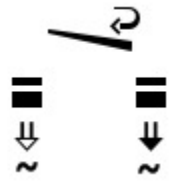
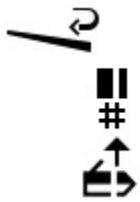

American Sign Language (ASL) Dictionary

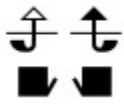
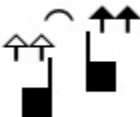
Unedited 08082023

Spoken Word	SignWriting
atmosphere	
atom	
attach bike seat on right	
attach handlebars on right	
attach small object to right	
attach to back of left hand	
attempt	
attend	

American Sign Language (ASL) Dictionary

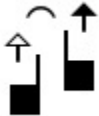
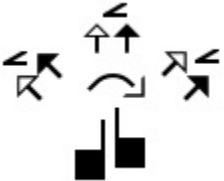
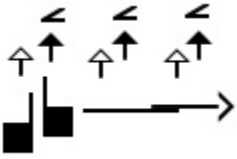
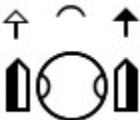
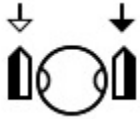
Unedited 08082023

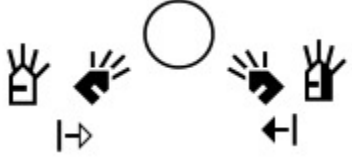
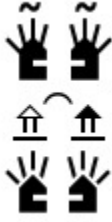
Spoken Word	SignWriting
attend	
attend many places	
attend many places	
attention	
attention	
attention	
attention (many people)	
attention above	







American Sign Language (ASL) Dictionary

Unedited 08082023

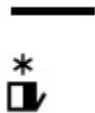
Spoken Word	SignWriting
attic	







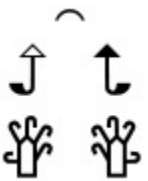

American Sign Language (ASL) Dictionary

Unedited 08082023

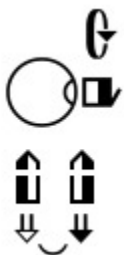
Spoken Word	SignWriting
attic	
attitude	
attitude	
attorney	
attorney	
attractive	
auction	







American Sign Language (ASL) Dictionary

Unedited 08082023

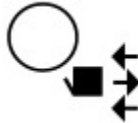
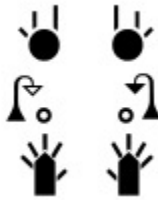
Spoken Word	SignWriting
audience	
audience	
audiologist	
audiologist	
audiology	
August	
aunt	
aunt	

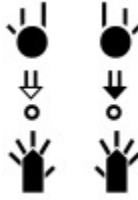



American Sign Language (ASL) Dictionary

Unedited 08082023

Spoken Word	SignWriting
<p style="text-align: center;">aunt</p>	
<p style="text-align: center;">aunt</p>	
<p style="text-align: center;">Australia</p>	
<p style="text-align: center;">Australia</p>	
<p style="text-align: center;">Australia</p>	
<p style="text-align: center;">Australian</p>	
<p style="text-align: center;">Austria</p>	
<p style="text-align: center;">Austria</p>	



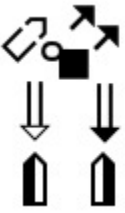
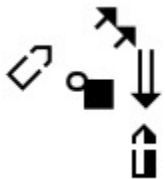
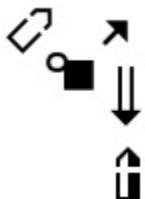



American Sign Language (ASL) Dictionary

Unedited 08082023

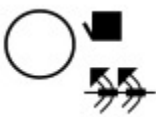
Spoken Word	SignWriting
Austria	
Austrian	
author	
author	
author	
authority	
autism	

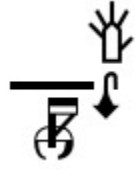
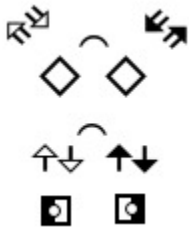
American Sign Language (ASL) Dictionary

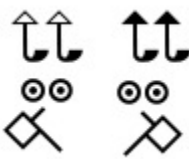
Unedited 08082023

Spoken Word	SignWriting
autism	
autism	
autism	
auto	
automatic	
automatic	
automatic	







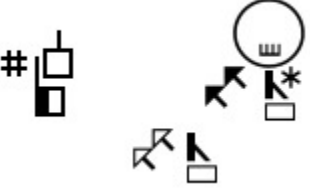

American Sign Language (ASL) Dictionary

Unedited 08082023

Spoken Word	SignWriting
automatically	
automatically	
automatically	
automatically	
automobile	
automobile	
automobile	
automobile	











American Sign Language (ASL) Dictionary

Unedited 08082023

Spoken Word	SignWriting
Autotroph	
autumn	
ave	
average	
average	
average	
average (in-between)	
avoid	





American Sign Language (ASL) Dictionary

Unedited 08082023

Spoken Word	SignWriting
aw	
aw	
awake	
awaken slowly	
awareness	
away	
away	
away	
awesome	
awesome	

American Sign Language (ASL) Dictionary

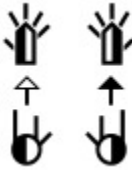
Unedited 08082023

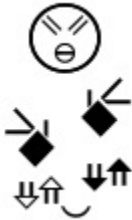
Spoken Word	SignWriting
awful	
awful	
awful	
awful	
awhile	
awkward	







American Sign Language (ASL) Dictionary

Unedited 08082023

Spoken Word	SignWriting
awkward	
B	
b-shake	
BA	
baby	
baby	
baby	
baby	
baby	
baby	

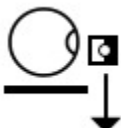
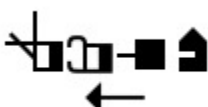
American Sign Language (ASL) Dictionary

Unedited 08082023

Spoken Word	SignWriting
babyish	
bachelor	
back	
back	
back	
back and forth	
back and forth	
back and forth	



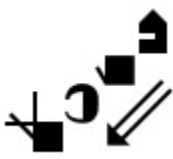
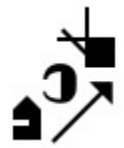
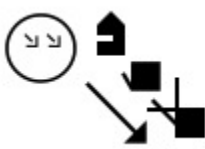
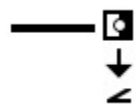
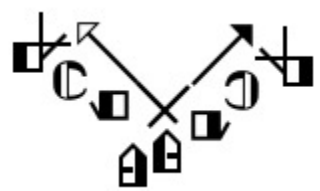
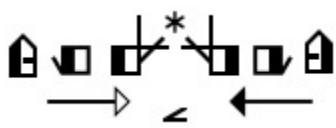
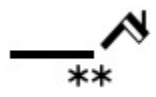
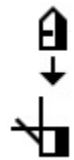

American Sign Language (ASL) Dictionary

Unedited 08082023

Spoken Word	SignWriting
back direction	
back direction	
back direction	
back in time	
back lexicalized	
back lexicalized	
back of body	
back to me	

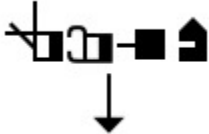



American Sign Language (ASL) Dictionary

Unedited 08082023

Spoken Word	SignWriting
back to you	
back toward signer	
back-and-forth	
background	
backpacking	

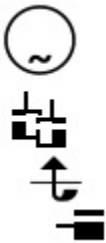
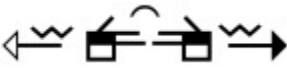
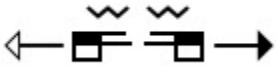

American Sign Language (ASL) Dictionary

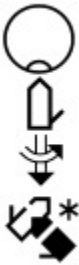
Unedited 08082023

Spoken Word	SignWriting
backstab	
backup	
backup	
bacon	
bacon	
bad	
bad	



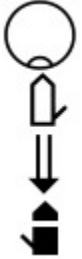

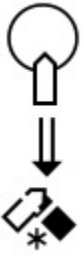
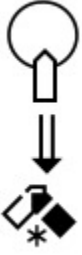
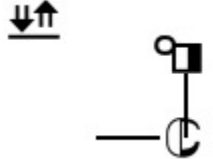

American Sign Language (ASL) Dictionary

Unedited 08082023

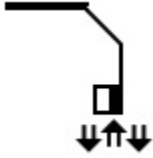
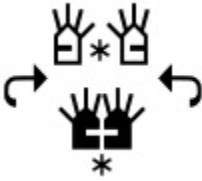
Spoken Word	SignWriting
bad	
bad	
bad	
bad	
bad	
bad sign	







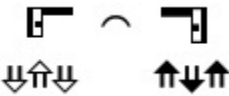

American Sign Language (ASL) Dictionary

Unedited 08082023

Spoken Word	SignWriting
bag	
Bagel	
baggage claim	
baggy clothing	
bake	
bake	
bake	
baking pan	

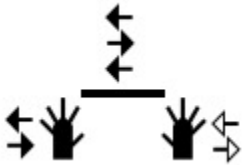

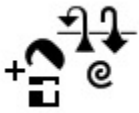

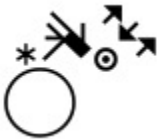

American Sign Language (ASL) Dictionary

Unedited 08082023

Spoken Word	SignWriting
balance	
balance	
balance	
balance	
balance	
balance	
bald	
bald	
bald	

American Sign Language (ASL) Dictionary

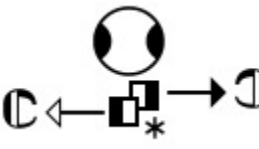
Unedited 08082023

Spoken Word	SignWriting
bald	
bald	
ball	
ball	
ballet	
ballet	
balloon	
balloon	
balloon	







American Sign Language (ASL) Dictionary

Unedited 08082023

Spoken Word	SignWriting
balloon	
ballot	
baloney	
Baltimore, Maryland	
Baltimore, Maryland	
banana	
banana	
banana	

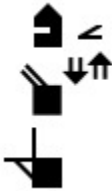

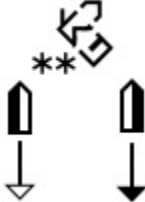

American Sign Language (ASL) Dictionary

Unedited 08082023

Spoken Word	SignWriting
band aid	
Bangladesh	
bangs hairstyle	
bank	
bank	
banker	
banner	



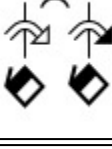

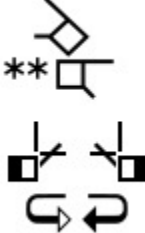
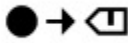



American Sign Language (ASL) Dictionary

Unedited 08082023

Spoken Word	SignWriting
banter	
baptist	
baptize	
baptize	
bar	
bar	
bar	
Barack Obama	

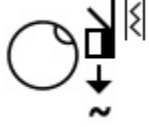

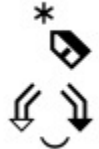
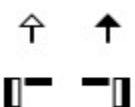





American Sign Language (ASL) Dictionary

Unedited 08082023

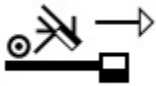
Spoken Word	SignWriting
Barack Obama	
Barack Obama	
Barack Obama	
barbeque	
barber	
barber	
bareheaded	
barn	
barn free jews	
baron	







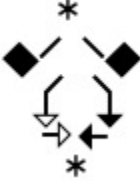

American Sign Language (ASL) Dictionary

Unedited 08082023

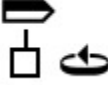
Spoken Word	SignWriting
baron	
baron	
baroness	
barren	
barrier	
baseball	
baseball	
baseball	
baseball-bat	









American Sign Language (ASL) Dictionary

Unedited 08082023

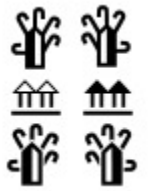
Spoken Word	SignWriting
baseball-plate	
basement	
basement	
bashful	
basic	
basic	
basically	
basket	
basket	

American Sign Language (ASL) Dictionary

Unedited 08082023

Spoken Word	SignWriting
basket	
basketball	
basketball	
basketball	
basketball	
bastard	
bat	
bat	

American Sign Language (ASL) Dictionary

Unedited 08082023

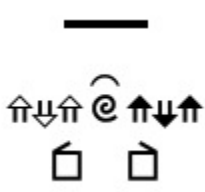
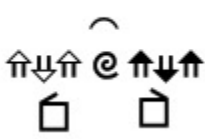
Spoken Word	SignWriting
bath	 <p style="font-size: small; margin: 0;">A diagram showing the SignWriting for the word 'bath'. At the top is a solid horizontal line. Below it, the letter 'b' is formed by a downward arrow on the left, an upward arrow on the right, and a central circle with a dot. The letter 'a' is formed by a downward arrow on the left, an upward arrow on the right, and a central circle with a dot. Below these are two small squares representing the feet of the letters.</p>
bath	 <p style="font-size: small; margin: 0;">A diagram showing the SignWriting for the word 'bath'. At the top is a curved horizontal line. Below it, the letter 'b' is formed by a downward arrow on the left, an upward arrow on the right, and a central circle with a dot. The letter 'a' is formed by a downward arrow on the left, an upward arrow on the right, and a central circle with a dot. Below these are two small squares representing the feet of the letters.</p>









American Sign Language (ASL) Dictionary

Unedited 08082023

Spoken Word	SignWriting
bath	<p>The signwriting for 'bath' consists of a horizontal line above a square, an '@' symbol, and another square. Below these are two sets of arrows: the left set has an up arrow, a down arrow, and an up arrow; the right set has an up arrow, a down arrow, and an up arrow.</p>
bath	<p>The signwriting for 'bath' is identical to the first entry, but includes two additional diagrams below. The first diagram shows two hands with fingers spread, one above the other. The second diagram shows two hands with fingers spread, one above the other, with circular arrows indicating movement.</p>
bath	<p>The signwriting for 'bath' consists of two sets of arrows (up, down, up) on the left and right. In the center is an '@' symbol. Below the arrows are two squares.</p>
bathe	<p>The signwriting for 'bathe' consists of a horizontal line above a square, an '@' symbol, and another square. Below these are two sets of arrows: the left set has an up arrow, a down arrow, and an up arrow; the right set has an up arrow, a down arrow, and an up arrow.</p>
bathrobe	<p>The signwriting for 'bathrobe' consists of two parts. The left part has a horizontal line above a square, an '@' symbol, and another square, with two sets of arrows (up, down, up) below. The right part has a horizontal line above two diamonds with asterisks, and below them are two circles with arrows and an '@' symbol.</p>
bathroom	<p>The signwriting for 'bathroom' consists of a circle with an arrow pointing up and two curved lines inside. Below it is a square with two arrows pointing right and two arrows pointing down.</p>
bathroom	<p>The signwriting for 'bathroom' consists of a square with two arrows pointing right and two arrows pointing down.</p>
battery	<p>The signwriting for 'battery' consists of two squares with two asterisks above them, and a square below.</p>

American Sign Language (ASL) Dictionary

Unedited 08082023

Spoken Word	SignWriting
battery	
battle	
bawl	
bbb	
be	
be	
be	
beach	
beach	







American Sign Language (ASL) Dictionary

Unedited 08082023

Spoken Word	SignWriting
beam	
bean	
bean	
beans	
beans	
beans	
bear	
bear	
bear	



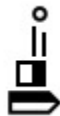
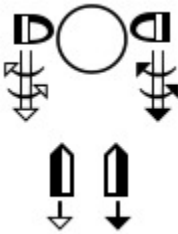

American Sign Language (ASL) Dictionary

Unedited 08082023

Spoken Word	SignWriting
beard	
beard	
bears	
beat	
beat	
beautician	
beautiful	

American Sign Language (ASL) Dictionary

Unedited 08082023

Spoken Word	SignWriting
beautiful	
beautiful	
beautiful	
beautiful	
beautiful	







American Sign Language (ASL) Dictionary

Unedited 08082023

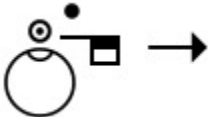
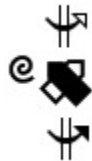
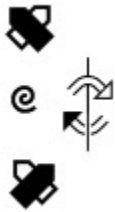
Spoken Word	SignWriting
beautiful	
beauty	
beauty	
beauty	
beauty	
beaver	
because	







American Sign Language (ASL) Dictionary

Unedited 08082023

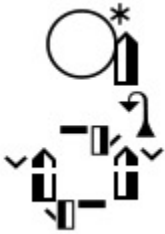
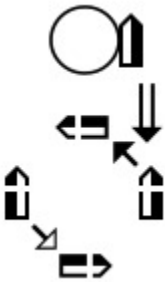
Spoken Word	SignWriting
Because	
become	
become	
bed	
bed	
bed	
bed	
bed-left	
bed-right	







American Sign Language (ASL) Dictionary

Unedited 08082023

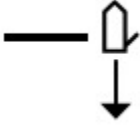
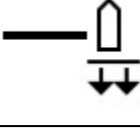
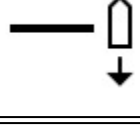
Spoken Word	SignWriting
bedroom	
bedroom	
bee	
beef	
beer	
before	
before	

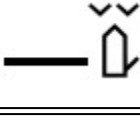
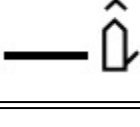

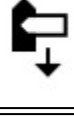



American Sign Language (ASL) Dictionary

Unedited 08082023

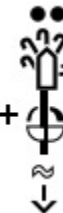
Spoken Word	SignWriting
before	
before	
before	
before	
before	
before	
before	
before	
before	
before	

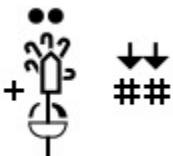
American Sign Language (ASL) Dictionary

Unedited 08082023

Spoken Word	SignWriting
beg	
beg	
beg	
beg	
beg	
begin	
Begin / Start	
Begin / Start	









American Sign Language (ASL) Dictionary

Unedited 08082023

Spoken Word	SignWriting
Begin / Start	<p>The signwriting consists of a vertical line with an asterisk on the left, followed by a hand with fingers spread pointing left, then a square, and finally a hand with fingers spread pointing right.</p>
beginning	<p>The signwriting shows a hand with fingers spread pointing down, followed by a square, a hand with fingers spread pointing up, and an asterisk below the square.</p>
beginning	<p>The signwriting features a hand with fingers spread pointing up, a square, a hand with fingers spread pointing right, and a hand with fingers spread pointing down.</p>
behave	<p>The signwriting includes two circles, each with a hand inside, and two hands with fingers spread pointing right.</p>
behave	<p>The signwriting shows a hand with fingers spread pointing up, a square, a hand with fingers spread pointing down, and a hand with fingers spread pointing right.</p>
behavior	<p>The signwriting consists of two hands with fingers spread pointing up, a hand with fingers spread pointing down, and a hand with fingers spread pointing right.</p>
behavior	<p>The signwriting shows a hand with fingers spread pointing up, a square, a hand with fingers spread pointing down, and a hand with fingers spread pointing right.</p>
behind	<p>The signwriting features two squares, an asterisk between them, and a hand with fingers spread pointing down.</p>
behind	<p>The signwriting shows a hand with fingers spread pointing up, a square, a hand with fingers spread pointing down, and a hand with fingers spread pointing right.</p>



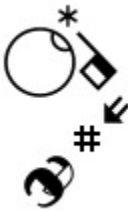

American Sign Language (ASL) Dictionary

Unedited 08082023

Spoken Word	SignWriting
belch	
Belgian	
Belgian	
Belgium	
Belgium	
Belgium	
belief	
believe	









American Sign Language (ASL) Dictionary

Unedited 08082023

Spoken Word	SignWriting
believe	
believe	
believe	
believe that	





American Sign Language (ASL) Dictionary

Unedited 08082023

Spoken Word	SignWriting
believe that	
bell	
bell	
Belle	
belly	
belong	
belong-to-God	
below	
belt	

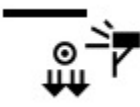
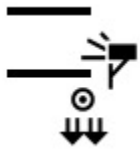
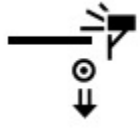
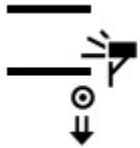

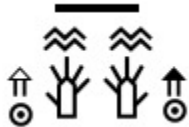

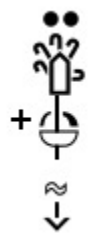



American Sign Language (ASL) Dictionary

Unedited 08082023

Spoken Word	SignWriting
benefit	
benefit	
benefit	
benefit	
Berkeley, California	
Bernie Sanders	
berry	
beseech	

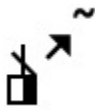
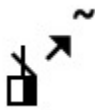
American Sign Language (ASL) Dictionary

Unedited 08082023

Spoken Word	SignWriting
best	
best	
best	
best	
Best-friend	
Best-friend	
Beta	
Beth	
Bethel	





American Sign Language (ASL) Dictionary

Unedited 08082023

Spoken Word	SignWriting
Bethel	
betray	
better	
better	
better	
better	
better-yesno	
between	
between	



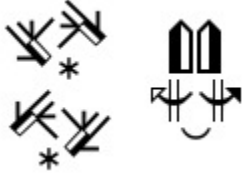
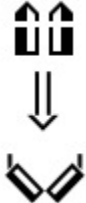

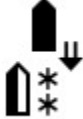

American Sign Language (ASL) Dictionary

Unedited 08082023

Spoken Word	SignWriting
beverage	
biannual	
Bible	
Bible	
Bible	
Bible	

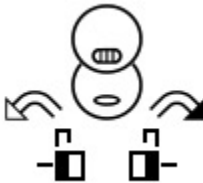



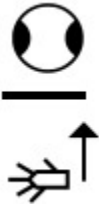

American Sign Language (ASL) Dictionary

Unedited 08082023

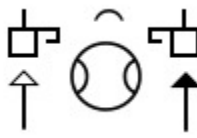
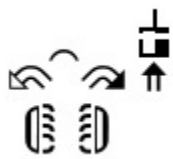
Spoken Word	SignWriting
biblical	
bicycle	
big	
big	
big	
big	
big belly	



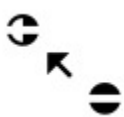
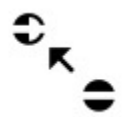



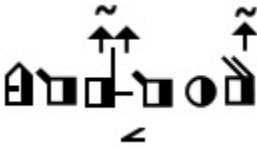

American Sign Language (ASL) Dictionary

Unedited 08082023

Spoken Word	SignWriting
big headed	
bigger	
bike	
bike	
bill	
billiards	
billiards	
billiards	
billion	





American Sign Language (ASL) Dictionary

Unedited 08082023

Spoken Word	SignWriting
billion lexicalized	
billion lexicalized	
bimonthly	
binary	
binder	 
Bingham	
binocular	

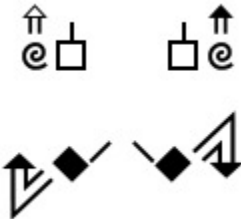
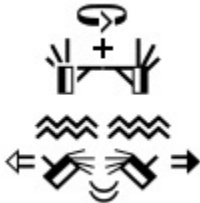



American Sign Language (ASL) Dictionary

Unedited 08082023

Spoken Word	SignWriting
Binoculars	
biodiversity	
biodiversity	
biography	
biography	
biology	
biome	

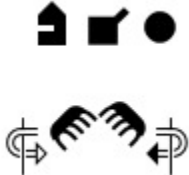
American Sign Language (ASL) Dictionary

Unedited 08082023

Spoken Word	SignWriting
biosphere	
biosphere	
biotic	
bird	
bird	
bird	







American Sign Language (ASL) Dictionary

Unedited 08082023

Spoken Word	SignWriting
birdcage	
birth	
birth	
birth	
Birthday	
birthday	





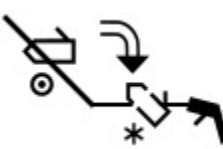

American Sign Language (ASL) Dictionary

Unedited 08082023

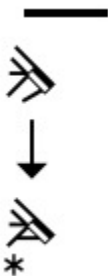
Spoken Word	SignWriting
birthday	
birthday	
birthday	
birthday	
birthday	
birthday	
BIRTHDAY	



American Sign Language (ASL) Dictionary

Unedited 08082023

Spoken Word	SignWriting
BIRTHDAY	
biscuit	
bisexual	
bishop	
bishop	
bishop	
bison	





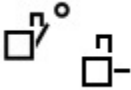

American Sign Language (ASL) Dictionary

Unedited 08082023

Spoken Word	SignWriting
bit	
bit	
bit	

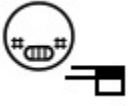
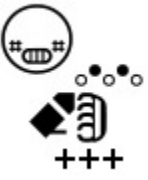
American Sign Language (ASL) Dictionary

Unedited 08082023

Spoken Word	SignWriting
bitch	
bite	
bite	
bite	
bite a person repeatedly	
biting	
bitter	
bitter	



American Sign Language (ASL) Dictionary

Unedited 08082023

Spoken Word	SignWriting
black	
black	
black	
black	
black hole	
black hole	
black-name	
blackjack	
blame	
blame	



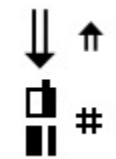
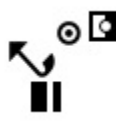
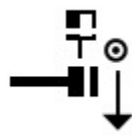
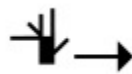
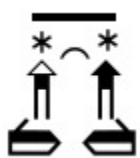
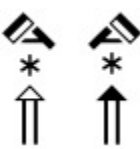
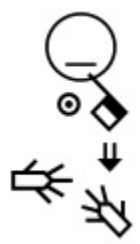

American Sign Language (ASL) Dictionary

Unedited 08082023

Spoken Word	SignWriting
blame	
blame	
blame myself	
blank	
blanket	
blanket	
bleed	
bleed	

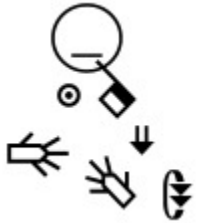
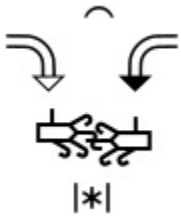

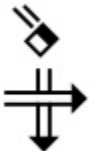
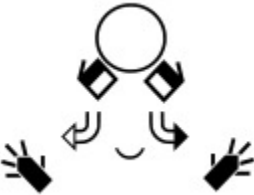

American Sign Language (ASL) Dictionary

Unedited 08082023

Spoken Word	SignWriting
bleeding	
blend	
bless	
bless	
bless	
bless	

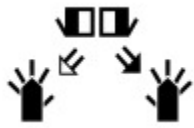



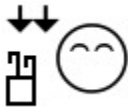
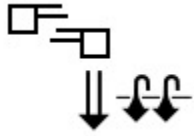



American Sign Language (ASL) Dictionary

Unedited 08082023

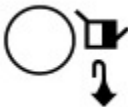
Spoken Word	SignWriting
bless	
Blessed	
blessedness	
blessing	
blessing	
blind	
blind	
blinds	







American Sign Language (ASL) Dictionary

Unedited 08082023

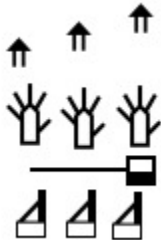
Spoken Word	SignWriting
block	
blog	
blond	
blood	
blood-pressure	
bloody arm	
bloody nose	
bloom	

American Sign Language (ASL) Dictionary

Unedited 08082023

Spoken Word	SignWriting
bloom (many flowers)	 <p>The signwriting for 'bloom (many flowers)' consists of three upward-pointing arrows at the top. Below them are three hand symbols with fingers spread, each with an upward-pointing arrow. A horizontal line is drawn across the middle, with a small square on the right side. At the bottom are three hand symbols with fingers spread, each with a downward-pointing arrow.</p>
blouse	 <p>The signwriting for 'blouse' starts with a horizontal line. Below it are two hand symbols with fingers spread, each with an upward-pointing arrow. A horizontal line is drawn across the middle, with a small square on the right side. Below that are two hand symbols with fingers spread, each with a downward-pointing arrow. At the bottom are two asterisks.</p>
blouse	 <p>The signwriting for 'blouse' starts with a horizontal line. Below it are two hand symbols with fingers spread, each with an upward-pointing arrow. A horizontal line is drawn across the middle, with a small square on the right side. Below that are two hand symbols with fingers spread, each with a downward-pointing arrow. At the bottom are two asterisks.</p>
blow	 <p>The signwriting for 'blow' consists of a hand symbol with fingers spread and an upward-pointing arrow. To its right is a hand symbol with fingers spread and a downward-pointing arrow. Below these is a hand symbol with fingers spread and a downward-pointing arrow. To its right is a hand symbol with fingers spread and an upward-pointing arrow.</p>
blow bubbles	 <p>The signwriting for 'blow bubbles' consists of a hand symbol with fingers spread and an upward-pointing arrow. To its right is a hand symbol with fingers spread and a downward-pointing arrow. Below these is a hand symbol with fingers spread and a downward-pointing arrow. To its right is a hand symbol with fingers spread and an upward-pointing arrow.</p>
blow out	 <p>The signwriting for 'blow out' consists of a hand symbol with fingers spread and an upward-pointing arrow. To its right is a hand symbol with fingers spread and a downward-pointing arrow. Below these is a hand symbol with fingers spread and a downward-pointing arrow. To its right is a hand symbol with fingers spread and an upward-pointing arrow.</p>
blow-at	 <p>The signwriting for 'blow-at' consists of a hand symbol with fingers spread and an upward-pointing arrow. To its right is a hand symbol with fingers spread and a downward-pointing arrow. Below these is a hand symbol with fingers spread and a downward-pointing arrow. To its right is a hand symbol with fingers spread and an upward-pointing arrow.</p>







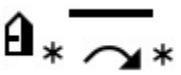

American Sign Language (ASL) Dictionary

Unedited 08082023

Spoken Word	SignWriting
blow-away	
blue	
blue	
blue	
blue	
blunt	
blush	
blush	





American Sign Language (ASL) Dictionary

Unedited 08082023

Spoken Word	SignWriting
board	
boast	
boast	
boat	
boat	
boat	
boat	
boat	
boat	



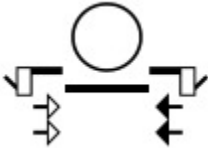
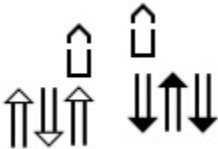
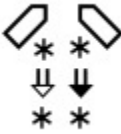



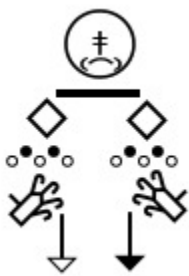

American Sign Language (ASL) Dictionary

Unedited 08082023

Spoken Word	SignWriting
boat moving fast	
boat turn around	
boat turn around	
bob hairstyle	
bobbled	
body	
body jerk	





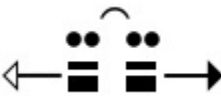

American Sign Language (ASL) Dictionary

Unedited 08082023

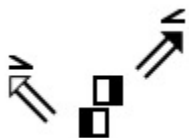
Spoken Word	SignWriting
body odor	
body shift	
body-shape	
boil	
boil	
Boise	
Bolivia	
Bolivia	
bologna	







American Sign Language (ASL) Dictionary

Unedited 08082023

Spoken Word	SignWriting
bomb	
bombdiggety	
bone	
bone	
bong	
boo	
book	









American Sign Language (ASL) Dictionary

Unedited 08082023

Spoken Word	SignWriting
book	
book	
book	
book	
book	
book	



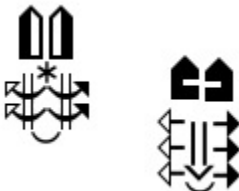



American Sign Language (ASL) Dictionary

Unedited 08082023

Spoken Word	SignWriting
BOOK	
BOOK2	
booklet	
booklet	
booklet	
booklet	
books	
bookshelf	
Boots	



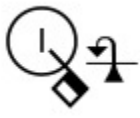
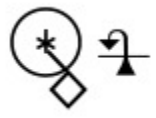

American Sign Language (ASL) Dictionary

Unedited 08082023

Spoken Word	SignWriting
boots	
boots	
bore	
bore	
bored	
boring	
boring	
boring	
boring	

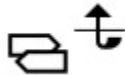
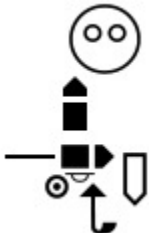
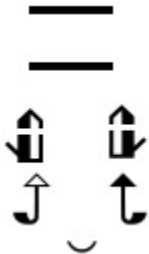



American Sign Language (ASL) Dictionary

Unedited 08082023

Spoken Word	SignWriting
born	
born	
born	
born	
born	
borrow	
borrow	

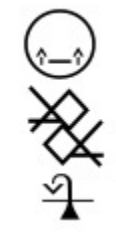
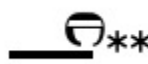
American Sign Language (ASL) Dictionary

Unedited 08082023

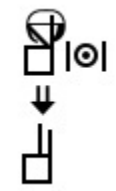
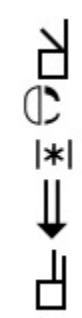
Spoken Word	SignWriting
borrow-from-me	
boss	
boss	
Boston, Massachusetts	
Boston, Massachusetts	
Boston, Massachusetts	
both	
both	





American Sign Language (ASL) Dictionary

Unedited 08082023

Spoken Word	SignWriting
both	<p>The signwriting for 'both' consists of a square box containing a horizontal double-headed arrow. Above the arrow is a circle with a vertical line through its center. To the right of the circle is a square box containing a diagonal line from the top-left to the bottom-right.</p>
both	<p>The signwriting for 'both' consists of a square box containing a horizontal double-headed arrow. Above the arrow is a circle with a vertical line through its center. To the right of the circle is a square box containing a diagonal line from the top-left to the bottom-right. Below the arrow is a circle with a dot in the center.</p>
both	<p>The signwriting for 'both' consists of a square box containing a horizontal double-headed arrow. Above the arrow is a circle with a vertical line through its center. To the right of the circle is a square box containing a diagonal line from the top-left to the bottom-right. Below the arrow is a circle with a dot in the center.</p>
both-of-us	<p>The signwriting for 'both-of-us' consists of a square box containing a horizontal double-headed arrow. Above the arrow is a circle with a vertical line through its center. To the right of the circle is a square box containing a diagonal line from the top-left to the bottom-right. Below the arrow is a circle with a dot in the center.</p>
both-of-us	<p>The signwriting for 'both-of-us' consists of a square box containing a horizontal double-headed arrow. Above the arrow is a circle with a vertical line through its center. To the right of the circle is a square box containing a diagonal line from the top-left to the bottom-right. Below the arrow is a circle with a dot in the center.</p>
bother	<p>The signwriting for 'bother' consists of a square box containing a horizontal double-headed arrow. Above the arrow is a circle with a vertical line through its center. To the right of the circle is a square box containing a diagonal line from the top-left to the bottom-right. Below the arrow is a circle with a dot in the center.</p>
bother-me	<p>The signwriting for 'bother-me' consists of a square box containing a horizontal double-headed arrow. Above the arrow is a circle with a vertical line through its center. To the right of the circle is a square box containing a diagonal line from the top-left to the bottom-right. Below the arrow is a circle with a dot in the center.</p>

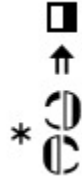

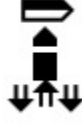

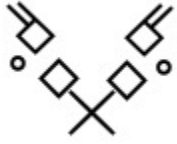
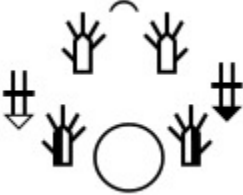

American Sign Language (ASL) Dictionary

Unedited 08082023

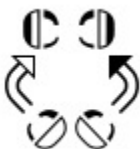
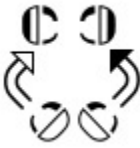
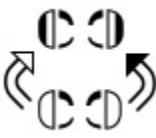
Spoken Word	SignWriting
bottle	
bottle	
bottle	
bottom	
bounce	
bounce check	
bow	
bow-down	





American Sign Language (ASL) Dictionary

Unedited 08082023

Spoken Word	SignWriting
bowl	
bowl	
bowl	
bowl	
bowling	
bowling	
bowling	
bowling	
bowling	

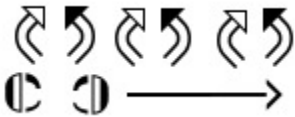

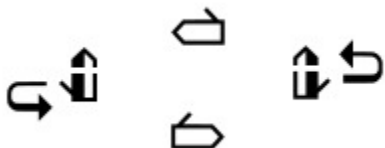
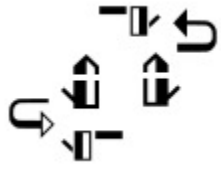





American Sign Language (ASL) Dictionary

Unedited 08082023

Spoken Word	SignWriting
bowling	
bowls	
bowtie	
box	
box	
box	
boxing	
boxing	

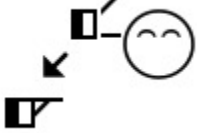

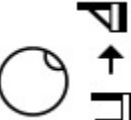

American Sign Language (ASL) Dictionary

Unedited 08082023

Spoken Word	SignWriting
boy	
boy	
boy	
boy	
boy	
boy	
boy	
boy	
boy	



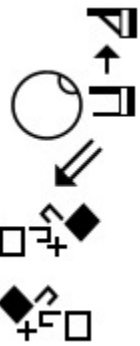
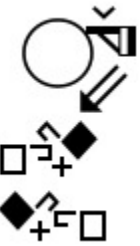

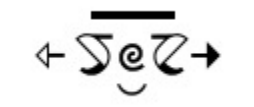

American Sign Language (ASL) Dictionary

Unedited 08082023

Spoken Word	SignWriting
boy - left hand	
boy-left-hand	
boyfriend	
boyfriend	
bra	
bra	
bra	

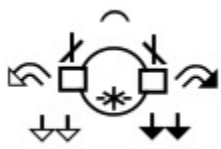





American Sign Language (ASL) Dictionary

Unedited 08082023

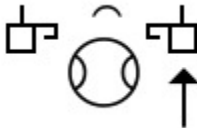
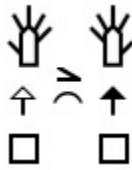
Spoken Word	SignWriting
Brace	
braid one's hair	
braiding one's hair	
braids	
braids	
brain	
brains	
brains	



American Sign Language (ASL) Dictionary

Unedited 08082023

Spoken Word	SignWriting
brake	
brat	
brave	
brave	
brave	
Brazil	
Brazil	
bread	



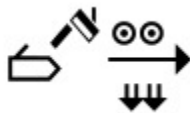

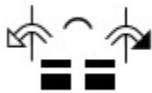

American Sign Language (ASL) Dictionary

Unedited 08082023

Spoken Word	SignWriting
bread	
bread	
break	



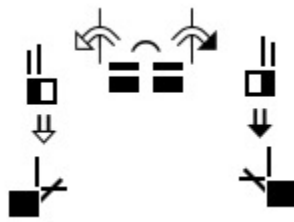
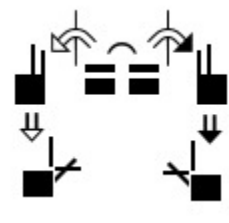

American Sign Language (ASL) Dictionary

Unedited 08082023

Spoken Word	SignWriting
break	
break	
break	
break	
break up	
break up	
breakdown	
breakfast	

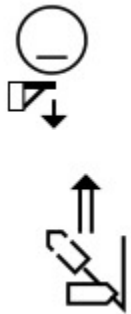

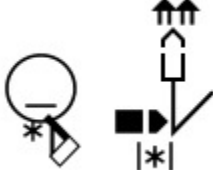
American Sign Language (ASL) Dictionary

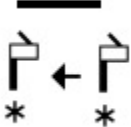
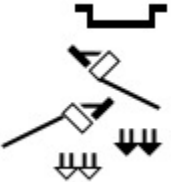
Unedited 08082023

Spoken Word	SignWriting
breakfast	
breakfast	
breakfast	
breakfast	
breast	
breastfeed	

American Sign Language (ASL) Dictionary

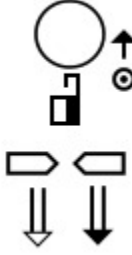
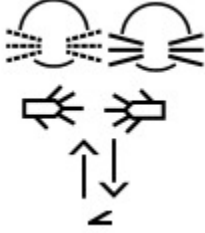
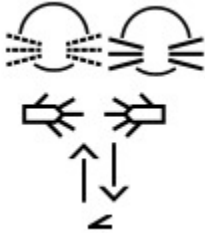
Unedited 08082023

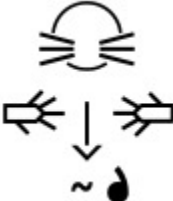
Spoken Word	SignWriting
breastplate	
breath	
breath	
breath	
breath	
breath-in	





American Sign Language (ASL) Dictionary

Unedited 08082023

Spoken Word	SignWriting
breath-in	
breath-in	
breathing mask	
breed	
breeze	
breif	

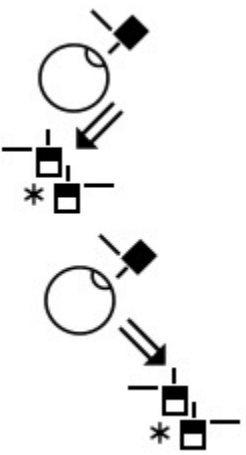
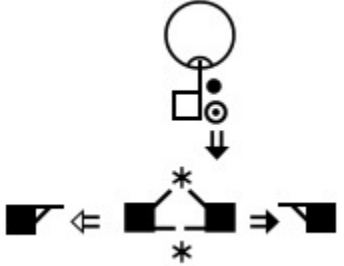





American Sign Language (ASL) Dictionary

Unedited 08082023

Spoken Word	SignWriting
brethren	
brick	
bride	
bridge	
brief	

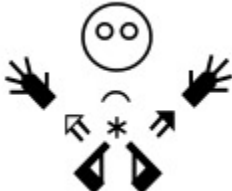





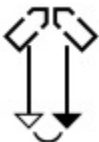

American Sign Language (ASL) Dictionary

Unedited 08082023

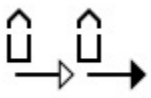
Spoken Word	SignWriting
bright	
bright	
bright	
bright-	
bright--	
bright-person	
bright-person	

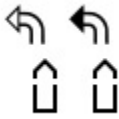
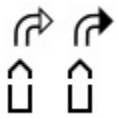







American Sign Language (ASL) Dictionary

Unedited 08082023

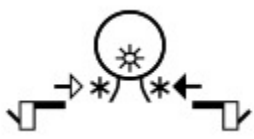
Spoken Word	SignWriting
bring	
bring	
bring	
bring (right)	
bring here	
bring-l	
bring-r	
bring-up	
broad	
broad	



American Sign Language (ASL) Dictionary

Unedited 08082023

Spoken Word	SignWriting
brochure	
brochure	
broke	
broke	
broke	
broke	
BROKE	
BROKE (no money)	
Broke (No Money)	

American Sign Language (ASL) Dictionary

Unedited 08082023

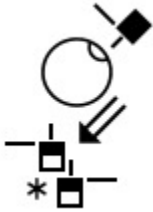
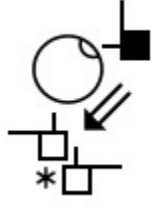
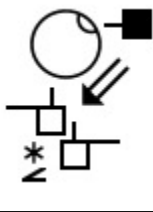
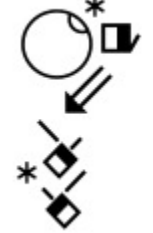
Spoken Word	SignWriting
brooch	
Brooklyn	
broom	
brother	
brother	
brother	
brother	





American Sign Language (ASL) Dictionary

Unedited 08082023

Spoken Word	SignWriting
brother	<p>The SignWriting symbol for 'brother' consists of a circle on the left, a square on the right, and a diagonal line with an arrow pointing down and to the right. Below these elements is a square with a diagonal line and an arrow pointing down and to the left.</p>
brother-in-law	<p>The SignWriting symbol for 'brother-in-law' is composed of two parts. The top part features a circle, a square, and a diagonal line with an arrow pointing down and to the right, with a small asterisk below the square. The bottom part features a square with a diagonal line and an arrow pointing down and to the left, with two small asterisks below it.</p>
brothers	<p>The SignWriting symbol for 'brothers' includes a circle, a square, and a diagonal line with an arrow pointing down and to the right. Below these is a square with a diagonal line and an arrow pointing down and to the left, with two small asterisks below it.</p>
brown	<p>The SignWriting symbol for 'brown' consists of a circle on the left, a square on the right, and a diagonal line with an arrow pointing down and to the right. Below these elements is a square with a diagonal line and an arrow pointing down and to the left.</p>
brown	<p>The SignWriting symbol for 'brown' consists of a circle on the left, a square on the right, and a diagonal line with an arrow pointing down and to the right. Below these elements is a square with a diagonal line and an arrow pointing down and to the left.</p>
brown	<p>The SignWriting symbol for 'brown' consists of a horizontal line above a square with a diagonal line and an arrow pointing down and to the left. Below the square are two arrows pointing up and down.</p>

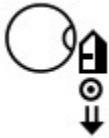
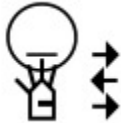

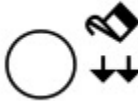

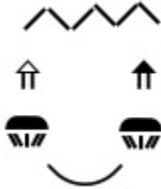

American Sign Language (ASL) Dictionary

Unedited 08082023

Spoken Word	SignWriting
brown	
brown	
brown	
browse	
brush	
brush-hair	
BS	
Bubble	

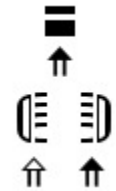
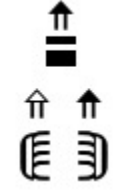

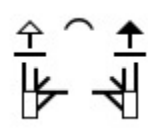



American Sign Language (ASL) Dictionary

Unedited 08082023

Spoken Word	SignWriting
bubbles	
buck teeth	
bucket	
bucket	
Buddha	
Buddha	
Buffalo	



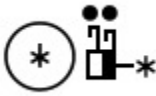
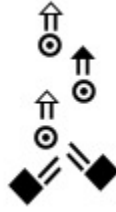
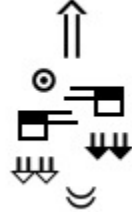

American Sign Language (ASL) Dictionary

Unedited 08082023

Spoken Word	SignWriting
buffalo	
buffalo	
buffalo	
bug	
bug	
build	
build	
building	

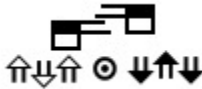
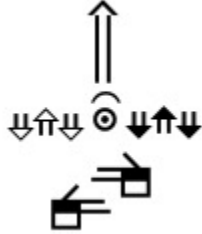





American Sign Language (ASL) Dictionary

Unedited 08082023

Spoken Word	SignWriting
building	
building	
building	
building there	
buildings	
Bulgaria	
Bulgarian	

American Sign Language (ASL) Dictionary

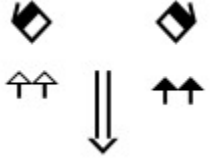
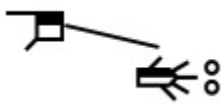
Unedited 08082023

Spoken Word	SignWriting
bull	
bull	
bull	
bull	
bull	
bulletin board	
bullshit	
bump	

American Sign Language (ASL) Dictionary

Unedited 08082023

Spoken Word	SignWriting
bump-on-hand	
bumpy	
bungee jumping	
bunny	
bunny	
bunny	
bunny	
Burbank, California	
burden	







American Sign Language (ASL) Dictionary

Unedited 08082023

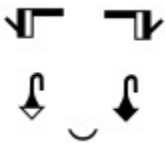
Spoken Word	SignWriting
burden	<p>The SignWriting for 'burden' consists of a vertical line on the left with a downward arrow. To its right, there is a series of four downward-pointing arrows, with a small asterisk between the second and third arrows. To the right of these arrows is a downward-pointing arrow with a small downward-pointing arrow below it.</p>
burn up	<p>The SignWriting for 'burn up' features three stacked circles at the top, each with a small circle inside. Below the circles is a wavy line. Underneath the wavy line are two hand symbols with fingers spread, facing each other. Below the hands are two sets of arrows: one pointing up and one pointing down. At the bottom are two house-like shapes with arrows pointing outwards from the sides.</p>
burn up	<p>The SignWriting for 'burn up' features three stacked circles at the top, each with a small circle inside. Below the circles is a wavy line. Underneath the wavy line are two hand symbols with fingers spread, facing each other. Below the hands are two sets of arrows: one pointing up and one pointing down. At the bottom are two small squares.</p>
burning	<p>The SignWriting for 'burning' starts with a face symbol with a wavy line for a mouth. Below the face is a hand symbol with fingers spread. To the right of the hand is a wavy line. Below the wavy line is another hand symbol with fingers spread. To the right of this hand is a small circle with a horizontal line through it.</p>
burning	<p>The SignWriting for 'burning' starts with a hand symbol with fingers spread. To the right of the hand is a wavy line. Below the wavy line is another hand symbol with fingers spread. To the right of this hand is a small circle with a horizontal line through it.</p>



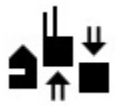



American Sign Language (ASL) Dictionary

Unedited 08082023

Spoken Word	SignWriting
burrito	
bury	
bus	
bus	
bus	
bus	
bushes	





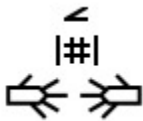
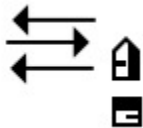

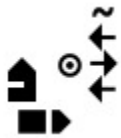

American Sign Language (ASL) Dictionary

Unedited 08082023

Spoken Word	SignWriting
bushes	
business	
business	
business	
businessman	
businessman	
busted	
Busy	



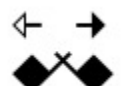





American Sign Language (ASL) Dictionary

Unedited 08082023

Spoken Word	SignWriting
busy	
busy	
busy	
but	
but	
but	
but2	
butter	
butter	



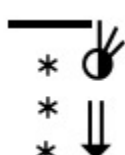





American Sign Language (ASL) Dictionary

Unedited 08082023

Spoken Word	SignWriting
butter	
butter	
butterfly	
butterfly	
butterfly	
butterfly-landing	
buttons	
buttons	









American Sign Language (ASL) Dictionary

Unedited 08082023

Spoken Word	SignWriting
buttons	
buy	
buy	
buy	
buying	
buzz	
by	
by	
By the way	
bye	



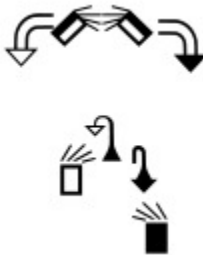



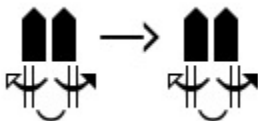
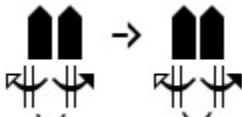

American Sign Language (ASL) Dictionary

Unedited 08082023

Spoken Word	SignWriting
bye	
Byron	
C	
C	
C	
C hand side view	
cab	
cabana	
cabbage	
cabinet	





American Sign Language (ASL) Dictionary

Unedited 08082023

Spoken Word	SignWriting
cabinet	
cabinet	
cactus	
cafeteria	
cafeteria	
cage	
cage	
cake	
cake	

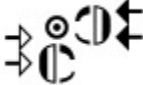

American Sign Language (ASL) Dictionary

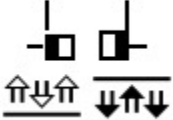
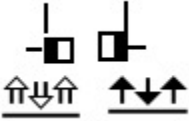
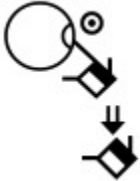
Unedited 08082023

Spoken Word	SignWriting
Calculator	
calculus	
Caldwell, Idaho	
calendar	
Calgary, Canada	
Calgary, Canada	
Calgary, Canada	
Calgary, Canada	
California	

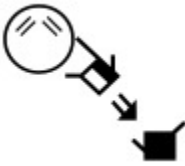

American Sign Language (ASL) Dictionary

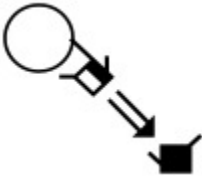
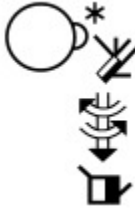
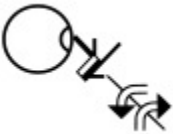
Unedited 08082023

Spoken Word	SignWriting
California	
California	
California	
California	
California	
California	







American Sign Language (ASL) Dictionary

Unedited 08082023

Spoken Word	SignWriting
California	 The SignWriting for 'California' consists of a smiley face with three horizontal lines above it, followed by a hand with fingers spread, and a downward-pointing arrow.
call	 The SignWriting for 'call' consists of two hands with fingers spread, a curved line above them, and two upward-pointing arrows.

American Sign Language (ASL) Dictionary

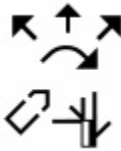
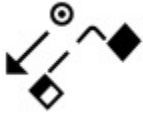
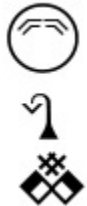
Unedited 08082023

Spoken Word	SignWriting
call	
call	
call	
call	
call	
call	
call	
call	
call	







American Sign Language (ASL) Dictionary

Unedited 08082023

Spoken Word	SignWriting
call	<p>The SignWriting for 'call' consists of a diamond shape with an arrow pointing up and to the right, a circle with a dot in the center, and a hand symbol with fingers spread pointing down and to the right.</p>
call me	<p>The SignWriting for 'call me' consists of a circle with a dot in the center, a diamond shape with an arrow pointing up and to the right, and a hand symbol with fingers spread pointing down and to the right.</p>
call-me-to-another	<p>The SignWriting for 'call-me-to-another' consists of a circle with a dot in the center, a diamond shape with an arrow pointing up and to the right, and a hand symbol with fingers spread pointing down and to the right.</p>
call-to-me	<p>The SignWriting for 'call-to-me' consists of a diamond shape with an arrow pointing up and to the right, a diamond shape with an arrow pointing down and to the right, and a diamond shape with an arrow pointing down and to the right.</p>
call-upon-God	<p>The SignWriting for 'call-upon-God' consists of a horizontal line, a diamond shape with an arrow pointing up and to the right, a diamond shape with an arrow pointing down and to the right, and a hand symbol with fingers spread pointing down and to the right.</p>
called	<p>The SignWriting for 'called' consists of a diamond shape with an arrow pointing up and to the right, a diamond shape with an arrow pointing down and to the right, and a hand symbol with fingers spread pointing down and to the right.</p>
calm	<p>The SignWriting for 'calm' consists of a circle with a horizontal line through it, a hand symbol with fingers spread pointing down and to the left, and a hand symbol with fingers spread pointing down and to the right.</p>

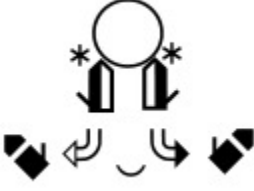



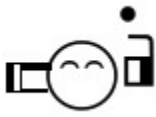
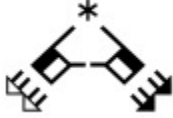



American Sign Language (ASL) Dictionary

Unedited 08082023

Spoken Word	SignWriting
calm	
calm	
calm	
Cambodia	
camel	
camera	
camera	
camp	

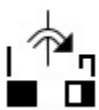





American Sign Language (ASL) Dictionary

Unedited 08082023

Spoken Word	SignWriting
camping	
can	
can	
can't	
can't	
Canada	
Canada	
Canada	
Canada	

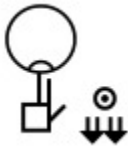

American Sign Language (ASL) Dictionary

Unedited 08082023

Spoken Word	SignWriting
Canadian	
cancel	
cancer	
candid	
candle	
candle burning	
candle burning	
candy	

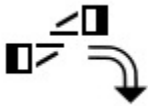
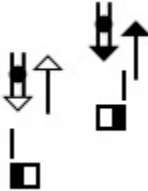
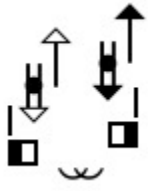
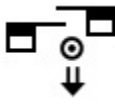
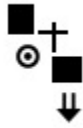
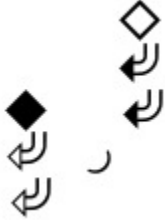

American Sign Language (ASL) Dictionary

Unedited 08082023

Spoken Word	SignWriting
candy	
candy	
cane	
cannons	
cannons	
cannot	
cannot	
canoe	

American Sign Language (ASL) Dictionary

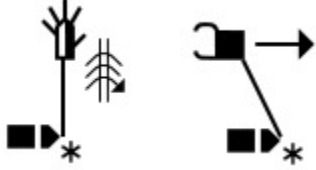
Unedited 08082023

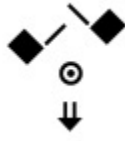
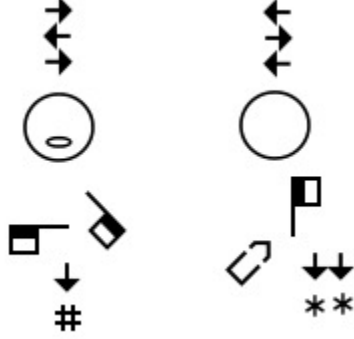
Spoken Word	SignWriting
canoe	
canopy	
Cansado	
cant	
cant afford	









American Sign Language (ASL) Dictionary

Unedited 08082023

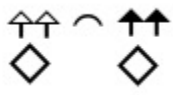
Spoken Word	SignWriting
cantor	
cap	
cape	
captain	
captain	
captain	
captions	
captions	
capture	

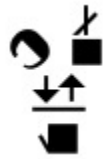







American Sign Language (ASL) Dictionary

Unedited 08082023

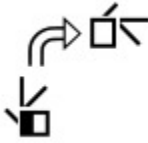
Spoken Word	SignWriting
car	
car	
car	
car	
car	
car	
car	
car	









American Sign Language (ASL) Dictionary

Unedited 08082023

Spoken Word	SignWriting
car	
car turn around	
car turn right	
card	
card playing	
cards	
care	
care	

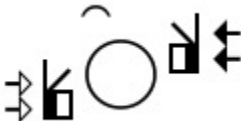



American Sign Language (ASL) Dictionary

Unedited 08082023

Spoken Word	SignWriting
care-self	
career	
careful	
careless	
careless	
careless	
careless	
cari turn around	

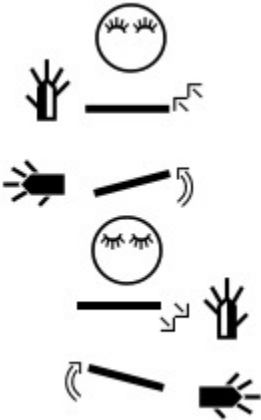

American Sign Language (ASL) Dictionary

Unedited 08082023

Spoken Word	SignWriting
Carmen Miranda	 <p>The SignWriting for 'Carmen Miranda' consists of two main parts. The first part shows a face with closed eyes, a horizontal line, a hand with fingers spread, and a hand with fingers spread. The second part shows a hand with fingers spread, a horizontal line, a hand with fingers spread, a face with closed eyes, a horizontal line, a hand with fingers spread, and a hand with fingers spread.</p>
Carmen-Miranda	 <p>The SignWriting for 'Carmen-Miranda' is identical to the one for 'Carmen Miranda'.</p>
carnival	 <p>The SignWriting for 'carnival' consists of two small square icons, two circular icons with internal patterns, and a small curved line.</p>
carnival	 <p>The SignWriting for 'carnival' consists of two small square icons, two circular icons with internal patterns, and a small curved line.</p>
carnival	 <p>The SignWriting for 'carnival' consists of two small square icons, two circular icons with internal patterns, and a small curved line.</p>

American Sign Language (ASL) Dictionary

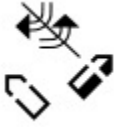
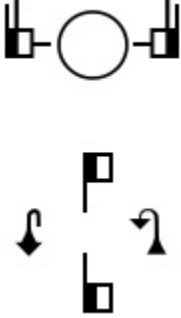
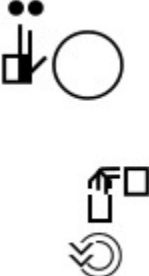
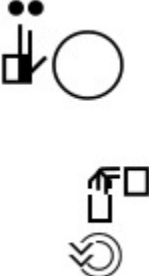
Unedited 08082023

Spoken Word	SignWriting
carnival midway	
carol	
carosel	
carousel	
carousel horse	
carpenter	





American Sign Language (ASL) Dictionary

Unedited 08082023

Spoken Word	SignWriting
carriage	
Carrie Fisher	



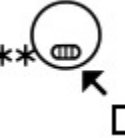

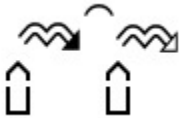
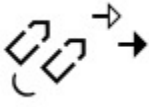
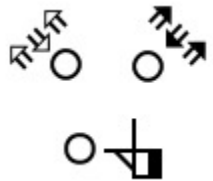
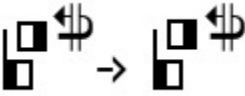

American Sign Language (ASL) Dictionary

Unedited 08082023

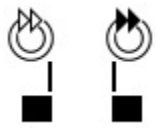
Spoken Word	SignWriting
carrot	
carrot	
carrot	
carrot	
carrot	
carry	
carry-on	
cars ok	
cases	

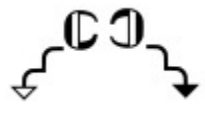

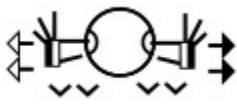



American Sign Language (ASL) Dictionary

Unedited 08082023

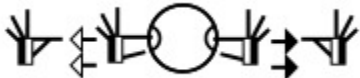
Spoken Word	SignWriting
cash register	
cassette tape	
castle	
castle	
casual sex	
casually	
cat	
cat	
cat	



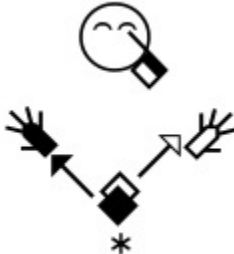
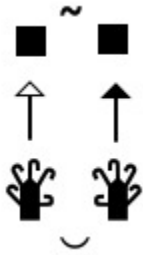



American Sign Language (ASL) Dictionary

Unedited 08082023

Spoken Word	SignWriting
cat	
cat	
cat's got your tongue	
catalina	
catalogue	
cataract	
catch	
catch	

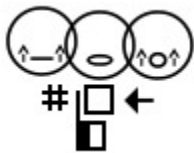

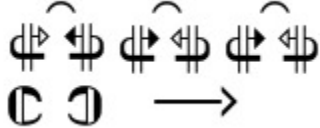

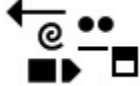
American Sign Language (ASL) Dictionary

Unedited 08082023

Spoken Word	SignWriting
catch	
catch	
catch	
catch an illness	
catch-up	
categories	
category	
caterpillar	

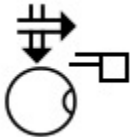
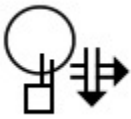



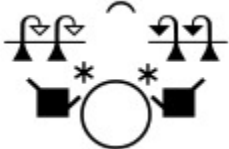
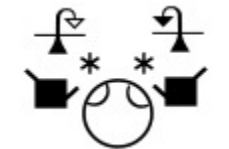

American Sign Language (ASL) Dictionary

Unedited 08082023

Spoken Word	SignWriting
Catholic	
catholic	
Catholic	
Catholic	
Cats-Meow	
cattle	
cattle	
cattle	



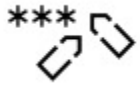
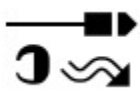





American Sign Language (ASL) Dictionary

Unedited 08082023

Spoken Word	SignWriting
cattle	
cattle	
caucasian	
cause	
caution	
cave	
cave	
cease	







American Sign Language (ASL) Dictionary

Unedited 08082023

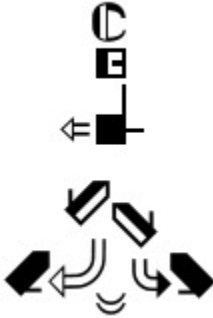
Spoken Word	SignWriting
ceiling	
ceiling	
celebrate	
celebrate	
celebrate	
celebration	
celebration	
celebration	

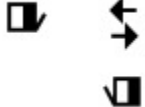



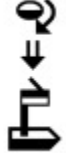



American Sign Language (ASL) Dictionary

Unedited 08082023

Spoken Word	SignWriting
Cell	
cell division	
cellar	
cello	
cemetery	
cent	
cent	
center	









American Sign Language (ASL) Dictionary

Unedited 08082023

Spoken Word	SignWriting
center	
center self	
centipede	
central	
central	
Central America	
Central America	
cereal	
cereal	
cereal	





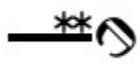

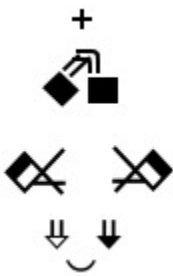

American Sign Language (ASL) Dictionary

Unedited 08082023

Spoken Word	SignWriting
cereal	
certain	
Chaeismatic	
chain	
chair	
chair	
chair	
chairperson	
chairperson	



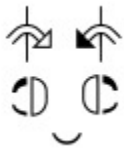



American Sign Language (ASL) Dictionary

Unedited 08082023

Spoken Word	SignWriting
chairperson	
chalk	
challenge	
champagne	
champagne	
champagne	
chance	
chance	

American Sign Language (ASL) Dictionary

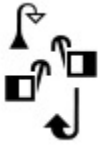
Unedited 08082023

Spoken Word	SignWriting
Chanel	
change	
change	
change	
change	
change	
change	







American Sign Language (ASL) Dictionary

Unedited 08082023

Spoken Word	SignWriting
change in balance	<p>The signwriting consists of a circle with a horizontal line through its center. To the right of the circle are two vertical arrows pointing upwards. Below the circle is a small square with a downward-pointing arrow.</p>
chant	<p>The signwriting features a slanted line on the left side. To its right is a square with a vertical line through its center, and two arrows pointing outwards from the right side of the square.</p>
chaos	<p>The signwriting includes a circle with two short horizontal lines inside. Below it are two hands with fingers spread, and a circular arrow indicating a clockwise rotation.</p>
chaos	<p>The signwriting shows a circle with two short horizontal lines inside. To its right is a hand with fingers spread, and below that is a circular arrow indicating a clockwise rotation.</p>
chapstick	<p>The signwriting depicts a circular arrow with a hand holding a stick, representing the application of lip balm.</p>
Chapter	<p>The signwriting shows a vertical bar on the left and a circle with a vertical line through its center on the right. Below these elements are two vertical arrows pointing downwards.</p>
chapter	<p>The signwriting features a vertical bar on the left and a circle with a vertical line through its center on the right. Below these elements are two vertical arrows pointing downwards.</p>



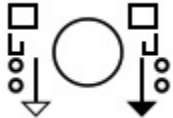

American Sign Language (ASL) Dictionary

Unedited 08082023

Spoken Word	SignWriting
character	
character looking in the distance	
character shift left coyote	
character shift right	
charge	
charge	
charge	
Chargers	

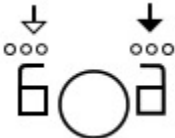
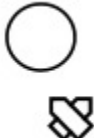
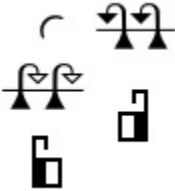
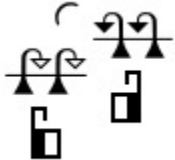

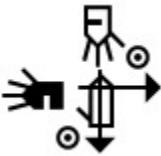
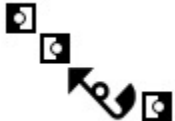





American Sign Language (ASL) Dictionary

Unedited 08082023

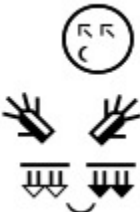
Spoken Word	SignWriting
Chargers	
charity	
charity	
charity	
Charles	
chart	
chase	
chat	







American Sign Language (ASL) Dictionary

Unedited 08082023

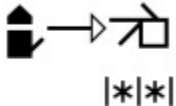
Spoken Word	SignWriting
chat	
chat	
chat-left	
cheap	
cheap	
cheap	
cheat	
cheat	

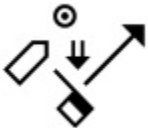



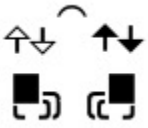

American Sign Language (ASL) Dictionary

Unedited 08082023

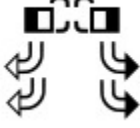
Spoken Word	SignWriting
cheat	
cheat	
check	
check	
check	
Check	
check the air	
checkers	







American Sign Language (ASL) Dictionary

Unedited 08082023

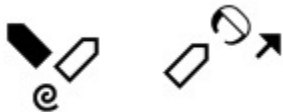
Spoken Word	SignWriting
checking	
checking	
cheese	
cheese	
cheese	
cheese	
cheese	





American Sign Language (ASL) Dictionary

Unedited 08082023

Spoken Word	SignWriting
cheese	
Cheesecake	
Cheetah	
chemist	
chemist	
Chemistry	
chemistry	
chemistry	

American Sign Language (ASL) Dictionary

Unedited 08082023

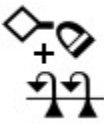
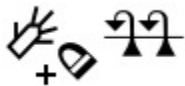
Spoken Word	SignWriting
chemotherapy	
Cherie Wren	
cherish	
cherish	
cherish	
cherry	
cherry	







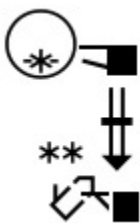

American Sign Language (ASL) Dictionary

Unedited 08082023

Spoken Word	SignWriting
cherry	
chess	
chestnut	
chewing	
chewing	
chewing	
chicago	
Chicago, Illinois	
Chicago, Illinois	
chicken	

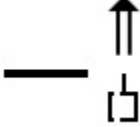



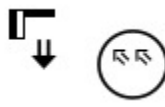



American Sign Language (ASL) Dictionary

Unedited 08082023

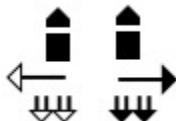
Spoken Word	SignWriting
chicken	
chicken	
chicken (coward)	
chief	
chief	
chihuahua	
child	
child	
child	

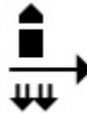
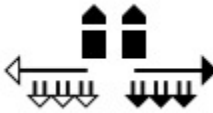

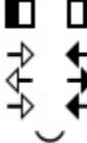

American Sign Language (ASL) Dictionary

Unedited 08082023

Spoken Word	SignWriting
child (left hand)	
child (right hand)	
children	
children	
children	
children	
children	
children	
chilly	
chin	

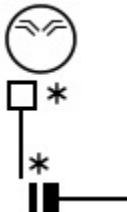
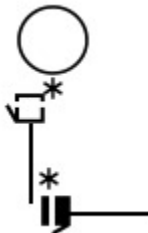
American Sign Language (ASL) Dictionary

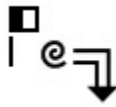
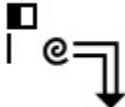
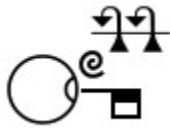
Unedited 08082023

Spoken Word	SignWriting
chin	
chin on hand	
chin resting on hand	
china	
china	
china	
China	
China	







American Sign Language (ASL) Dictionary

Unedited 08082023

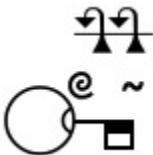
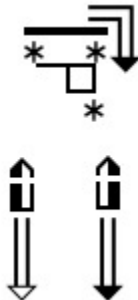
Spoken Word	SignWriting
China	<p>The SignWriting for 'China' consists of a thick horizontal line at the top. Below it, a square is formed by a vertical line on the left, a horizontal line on the bottom, and a vertical line on the right. Two asterisks are placed on the left and right sides of the square. To the right of the square, a downward-pointing arrow is shown with a hook at its tip. Below the square, a thick horizontal line is shown with an asterisk centered underneath it.</p>
Chinese	<p>The SignWriting for 'Chinese' consists of a small square at the top left. Below it, a vertical line descends. To the right of this vertical line is a circle with a dot in the center. To the right of the circle is a downward-pointing arrow with a hook at its tip. Below the arrow, a tilde symbol (~) is positioned.</p>

American Sign Language (ASL) Dictionary

Unedited 08082023

Spoken Word	SignWriting
Chinese	
Chinese	
Chinese	
Chinese person	
chip in	
chips	
chiropractic	







American Sign Language (ASL) Dictionary

Unedited 08082023

Spoken Word	SignWriting
chiropractic	
chiropractic	
chiropractor	
chiropractor	
chocolate	
chocolate	
choices	



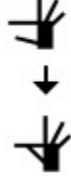



American Sign Language (ASL) Dictionary

Unedited 08082023

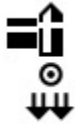
Spoken Word	SignWriting
choices	
choke	
cholesterol	
cholesterol	
choose	
choose	
choose	
chop	

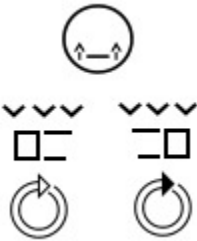





American Sign Language (ASL) Dictionary

Unedited 08082023

Spoken Word	SignWriting
chop	
chop	
chop	
chores	
Christ	
Christ-2	
Christian	





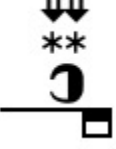

American Sign Language (ASL) Dictionary

Unedited 08082023

Spoken Word	SignWriting
Christian	
Christmas	
Christmas	
chrysalis	
chubby	
chubby	
chug	
church	

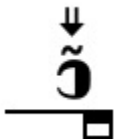





American Sign Language (ASL) Dictionary

Unedited 08082023

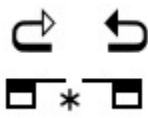
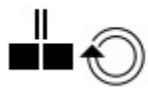
Spoken Word	SignWriting
church	
church	
church	
church	
cigarette	
cigarette	
Cilicia	
Cinderella	

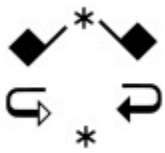





American Sign Language (ASL) Dictionary

Unedited 08082023

Spoken Word	SignWriting
cinza	
circle	
circle	
circle	
circle	
circle	
circle	
circle forward left hand	
Circle K	

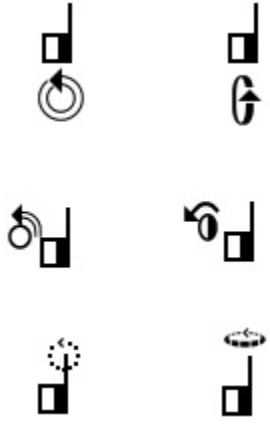







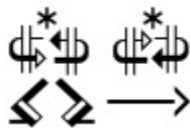

American Sign Language (ASL) Dictionary

Unedited 08082023

Spoken Word	SignWriting
circle up and forward	
circles1	
Circular Movement	
circus	
city	
city	



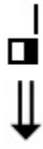



American Sign Language (ASL) Dictionary

Unedited 08082023

Spoken Word	SignWriting
city	
city	
city	
city	
city	
cl-1	
cl-1	
cl-1	
cl-1 dropping	
cl-2	

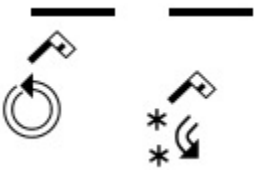

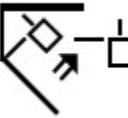
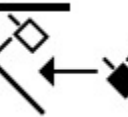
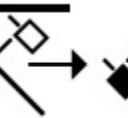





American Sign Language (ASL) Dictionary

Unedited 08082023

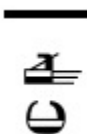
Spoken Word	SignWriting
cl-blood-flow	
cl-blood-flow	
cl-breast-exam-lump	
CL-C-POSSESSIVE	
cl-draw-blood-arm	
cl-draw-blood-arm-share	
cl-draw-blood-arm-share	
cl-draw-blood-hand	



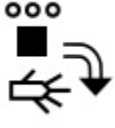

American Sign Language (ASL) Dictionary

Unedited 08082023

Spoken Word	SignWriting
cl-eye-tension	
CL-FF	
cl-going-each-person	
cl-growth	
cl-insert-hole-middle	
cl-insert-to-hole	
cl-list-next	
cl-list-throw	
cl-list-throw-four	

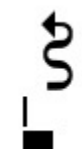

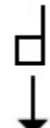
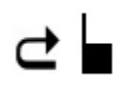
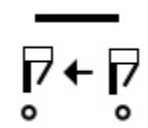
American Sign Language (ASL) Dictionary

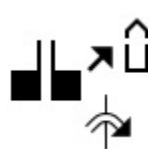
Unedited 08082023

Spoken Word	SignWriting
cl-modV-left	
cl-move	
cl-person walking forward	
cl-person walking toward	
cl-person-move	
cl-picture-breast	
cl-pipe-flow	
cl-pipe-slow-flow	
cl-spouse-dead	



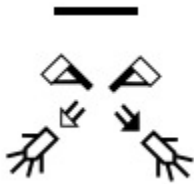
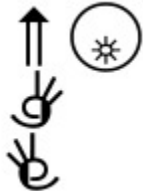

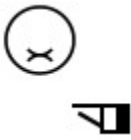



American Sign Language (ASL) Dictionary

Unedited 08082023

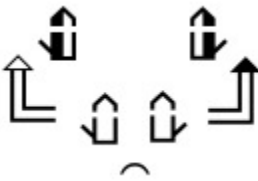
Spoken Word	SignWriting
cl-spread	
CL-tall-narrow-pole	
CL-tall-vertical-pole	
cl-thin	

American Sign Language (ASL) Dictionary

Unedited 08082023

Spoken Word	SignWriting
cl-throw-face	
cl-throw-face	
cl-throw-in-mouth	
cl-tub	
cl-tube	
cl-wall (left)	
CL1	
cl:3 moving	
Clam	
clap	





American Sign Language (ASL) Dictionary

Unedited 08082023

Spoken Word	SignWriting
clap	<p>The sign for 'clap' is represented by a hand icon with fingers spread, positioned above two hash symbols (#).</p>
class	<p>The sign for 'class' is represented by two hand icons with fingers spread, one above the other, with a small asterisk (*) between them.</p>
class	<p>The sign for 'class' is represented by two hand icons with fingers spread, one above the other.</p>
class	<p>The sign for 'class' is represented by two hand icons with fingers spread, one above the other, with a small curved line above the top hand.</p>
class	<p>The sign for 'class' is represented by two hand icons with fingers spread, one above the other, with a small asterisk (*) above the top hand and a small curved line above the bottom hand.</p>
class	<p>The sign for 'class' is represented by two hand icons with fingers spread, one above the other, with a small curved line above the top hand and a small asterisk (*) above the bottom hand.</p>
classes	<p>The sign for 'classes' is represented by a complex arrangement of multiple hand icons with fingers spread, arranged in a grid-like pattern.</p>

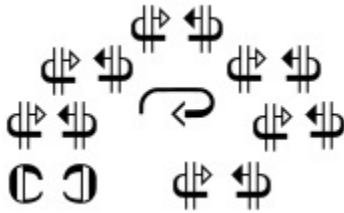

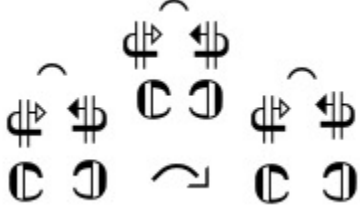
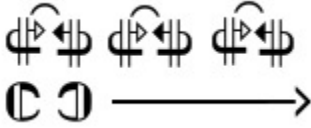



American Sign Language (ASL) Dictionary

Unedited 08082023

Spoken Word	SignWriting
classes	
classes	
classes	
classes	
classes	
classical	
classifier	

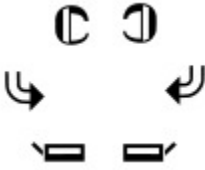
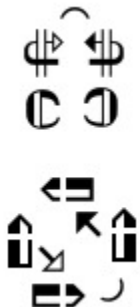
American Sign Language (ASL) Dictionary

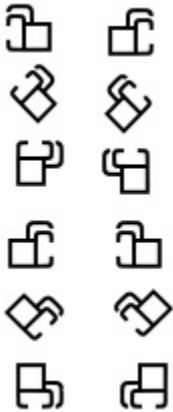
Unedited 08082023

Spoken Word	SignWriting
classifier (linguistic)	
classifier walk zigzag to left	
classify	
classroom	
claw classifier	
claw comparison	
clean	





American Sign Language (ASL) Dictionary

Unedited 08082023

Spoken Word	SignWriting
clean repeatedly	<p>The SignWriting symbol consists of four circles stacked vertically. The top circle contains an 'X'. The second circle contains a horizontal line with a dot in the center. The third circle contains an 'X'. The bottom circle contains a horizontal line with a dot in the center. Below the circles is a hand icon with an arrow pointing up and to the right, and another hand icon with an arrow pointing up and to the left, indicating a repeated motion.</p>
clean-over-time	<p>The SignWriting symbol shows a hand icon with an arrow pointing up and to the right, and another hand icon with an arrow pointing up and to the left, indicating a repeated motion over time.</p>
clear	<p>The SignWriting symbol shows two hand icons with arrows pointing outwards from the center, indicating a clearing motion.</p>
clear	<p>The SignWriting symbol shows two hand icons with arrows pointing outwards from the center, and two zigzag lines above each hand, indicating a clearing motion with a specific hand shape.</p>
click	<p>The SignWriting symbol shows a hand icon with an arrow pointing up and another hand icon with an arrow pointing down, indicating a clicking motion.</p>
client	<p>The SignWriting symbol consists of two circles side-by-side, each containing a horizontal line with a dot in the center. Below the circles is a double-headed vertical arrow pointing down.</p>

American Sign Language (ASL) Dictionary

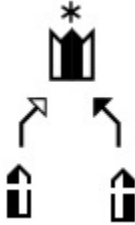
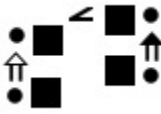
Unedited 08082023

Spoken Word	SignWriting
cliff edge	
climate	
climax	
climb	
climb	
clinic	

American Sign Language (ASL) Dictionary

Unedited 08082023

Spoken Word	SignWriting
Clinton	
clitoris	
clock	
clock	
clock	
clock	
clock	

American Sign Language (ASL) Dictionary

Unedited 08082023

Spoken Word	SignWriting
close	
close book	
close call	
close door	
close door	
close doors	
close eyes	
close eyes	





American Sign Language (ASL) Dictionary

Unedited 08082023

Spoken Word	SignWriting
close wide open mouth	<p>The signwriting consists of two circles at the top. The left circle contains the number '0', and the right circle contains a horizontal line. Below these are two hand icons. The first hand icon has fingers spread, with arrows pointing up and down. The second hand icon has fingers spread, with an arrow pointing up and another pointing right.</p>
close window	<p>The signwriting shows a hand icon with fingers spread, with an arrow pointing down towards a window icon (a rectangle with a pointed top).</p>
close-window	<p>The signwriting shows a hand icon with fingers spread, with an arrow pointing down towards a window icon. A small asterisk is placed to the left of the window icon.</p>
close-window	<p>The signwriting shows a hand icon with fingers spread, with an arrow pointing down towards a window icon. A small asterisk is placed to the left of the window icon.</p>
closet	<p>The signwriting shows two hand icons with fingers spread, positioned above a horizontal line. Below the line is a small curved line.</p>
closet	<p>The signwriting shows a hand icon with fingers spread, with an arrow pointing right towards a window icon. Three plus signs are placed above the window icon.</p>
closet	<p>The signwriting shows a horizontal line at the top. Below it, two hand icons with fingers spread are positioned above a horizontal line. An arrow points right from the first hand icon to the second. Below the second hand icon is a small curved line.</p>
closet	<p>The signwriting shows a hand icon with fingers spread, with an arrow pointing right towards a window icon. Three plus signs are placed above the window icon.</p>

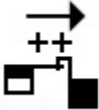
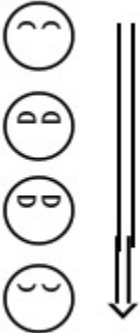
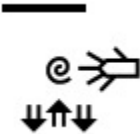
American Sign Language (ASL) Dictionary

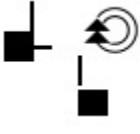
Unedited 08082023

Spoken Word	SignWriting
closet	
closing-your-eyes	
cloth	
clothes	
clothes	
clothes dryer	
clothing	







American Sign Language (ASL) Dictionary

Unedited 08082023

Spoken Word	SignWriting
cloud	
cloud	
clouds	
clouds	
cloudy	





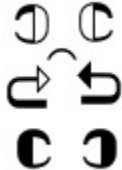



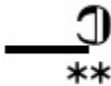

American Sign Language (ASL) Dictionary

Unedited 08082023

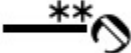
Spoken Word	SignWriting
cloudy	
clown	
clown	
clown	
clown	
clown	
club	
club	

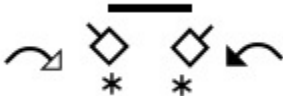

American Sign Language (ASL) Dictionary

Unedited 08082023

Spoken Word	SignWriting
club	
club	
coach	
coach	
coach	
coarse	
coat	
coat	
cobra	
cochlear implant	
cockroach	







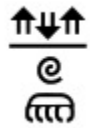

American Sign Language (ASL) Dictionary

Unedited 08082023

Spoken Word	SignWriting
Coco	
coconut	
coconut	









American Sign Language (ASL) Dictionary

Unedited 08082023

Spoken Word	SignWriting
cocount	
code switching	
Cody	
coffee	
coffee	
coffee	
coin	
coins	
coins	
Coke	







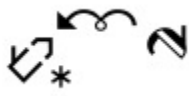

American Sign Language (ASL) Dictionary

Unedited 08082023

Spoken Word	SignWriting
Coke	
Coke	
cold	
cold	
cold	
cold	
cold	
collar	
collar	









American Sign Language (ASL) Dictionary

Unedited 08082023

Spoken Word	SignWriting
collect	
college	
college	
college	
Collin	
Collin	
Colombia	
Colombia	
Colombia	







American Sign Language (ASL) Dictionary

Unedited 08082023

Spoken Word	SignWriting
colon	
color	
color	
color	
color	
color	
Color (LSA)	
Colorado	

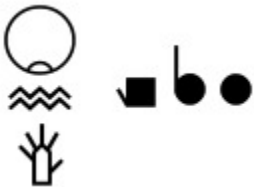
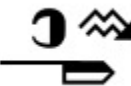





American Sign Language (ASL) Dictionary

Unedited 08082023

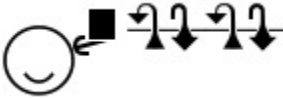
Spoken Word	SignWriting
Colorado	
Colorado	
Colorado	
Colorado	
colorful	
colorful	
Colors	





American Sign Language (ASL) Dictionary

Unedited 08082023

Spoken Word	SignWriting
Colors	
Colors	
Colors	
Colors	
Colors	
COLORS	
Colors	

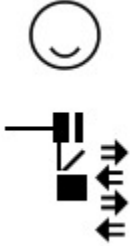





American Sign Language (ASL) Dictionary

Unedited 08082023

Spoken Word	SignWriting
Colors	
Colors	
Colors	
Colors	
Colors	
Colors	

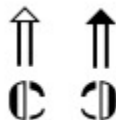

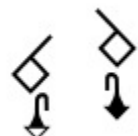

American Sign Language (ASL) Dictionary

Unedited 08082023

Spoken Word	SignWriting
Colossians	
column	
column	
column top down	
comb	
come	
come	

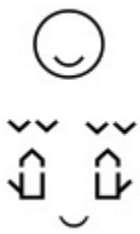
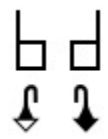
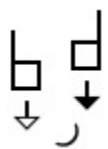

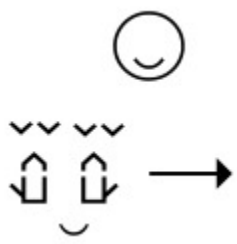
American Sign Language (ASL) Dictionary

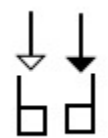
Unedited 08082023

Spoken Word	SignWriting
come	
come	
come	
come	
come	
come	
come	



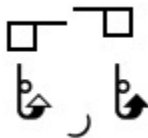
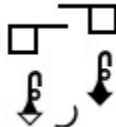
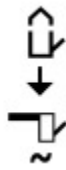
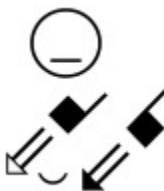
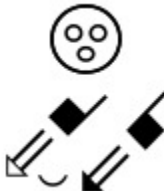
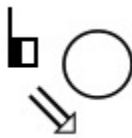



American Sign Language (ASL) Dictionary

Unedited 08082023

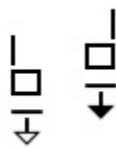
Spoken Word	SignWriting
come	
come	
come here	
come-	
come-2	
come-down	
come-here	

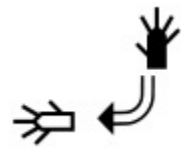

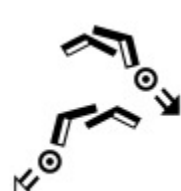



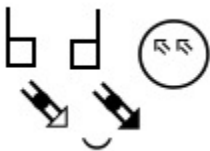

American Sign Language (ASL) Dictionary

Unedited 08082023

Spoken Word	SignWriting
come-here	
come-here-boy	
come-on	
comfort	
comfortable	
comfortable	





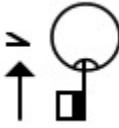

American Sign Language (ASL) Dictionary

Unedited 08082023

Spoken Word	SignWriting
comic	
coming	
comma	
comma	
comma	
comma	
comma	
comma	
command	
command	

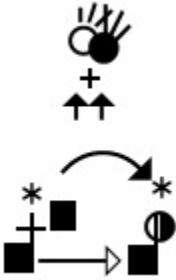

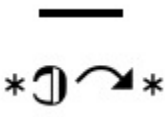

American Sign Language (ASL) Dictionary

Unedited 08082023

Spoken Word	SignWriting
commandment	
commandments	
commend	
commensalism	
commercial	
committee	
common	



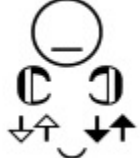
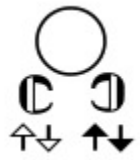
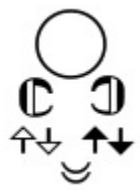
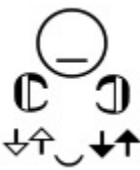



American Sign Language (ASL) Dictionary

Unedited 08082023

Spoken Word	SignWriting
common	
common	
communicate	
communicate	
communicate	
communication	
communion	
communist	

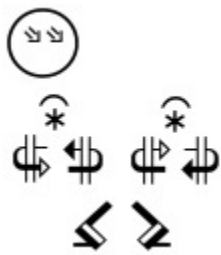
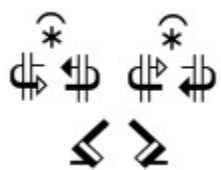

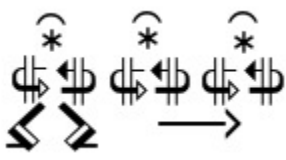

American Sign Language (ASL) Dictionary

Unedited 08082023

Spoken Word	SignWriting
communist	
communist	
community	
community	
community	
community	
community	
community	
commute	



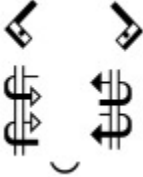
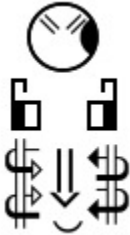

American Sign Language (ASL) Dictionary

Unedited 08082023

Spoken Word	SignWriting
companion	
company	
compare	
compare	
comparison	
comparison	
compass	

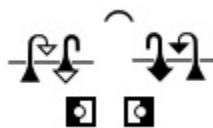
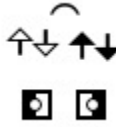
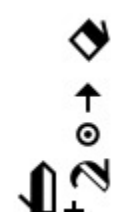

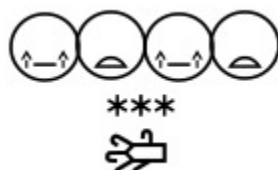

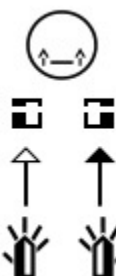

American Sign Language (ASL) Dictionary

Unedited 08082023

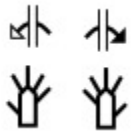
Spoken Word	SignWriting
compatible	
compete	
compete	
competent	
complain	
complaining	
complete	
complete	

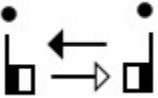
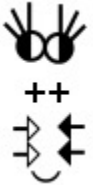

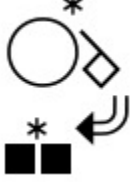
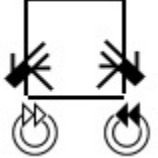

American Sign Language (ASL) Dictionary

Unedited 08082023

Spoken Word	SignWriting
complete	
completed	
complex	
compound	
compound	
compromise	
Computer	
computer	



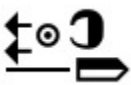
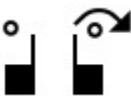
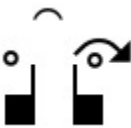
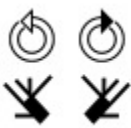
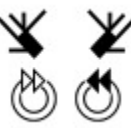
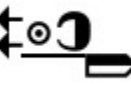





American Sign Language (ASL) Dictionary

Unedited 08082023

Spoken Word	SignWriting
computer	
computer	
computer	
computer	
computer	
computer	
computer	
computer	
computer	



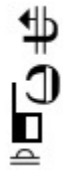



American Sign Language (ASL) Dictionary

Unedited 08082023

Spoken Word	SignWriting
computer mouse	
computer mouse	
comrade	
concept	
concern	
concise	
condensation	
condition	
condom	



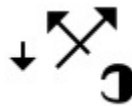

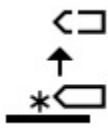

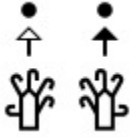

American Sign Language (ASL) Dictionary

Unedited 08082023

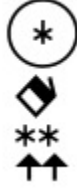
Spoken Word	SignWriting
condom	
Conduction	
cone	
cone	
confederate	
confess	
confess	
confession	





American Sign Language (ASL) Dictionary

Unedited 08082023

Spoken Word	SignWriting
confidence	
confident	
confidential	
confirm	
conflict	
conflict	
conflict	
conflict	

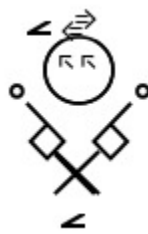

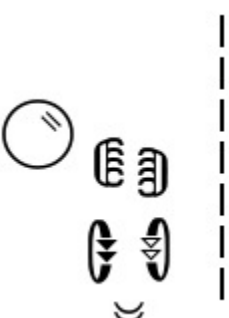
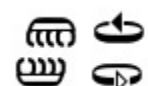

American Sign Language (ASL) Dictionary

Unedited 08082023

Spoken Word	SignWriting
conflict	
conflict	
conflicts	
confront	
confused	
Confused	
confused	

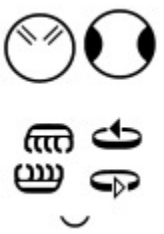

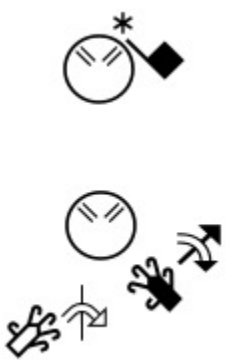

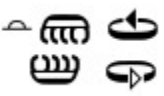



American Sign Language (ASL) Dictionary

Unedited 08082023

Spoken Word	SignWriting
confused	
confused	
confused	
confused	
confused	
confusion	

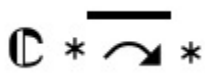

American Sign Language (ASL) Dictionary

Unedited 08082023

Spoken Word	SignWriting
confusion	
congratulations	
congratulations	
congress	
congress	
congressman	
connect	
connect	



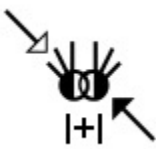
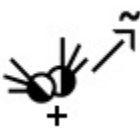







American Sign Language (ASL) Dictionary

Unedited 08082023

Spoken Word	SignWriting
connect	
Connect 4 game	
connected with	
connected with	
Connecticut	







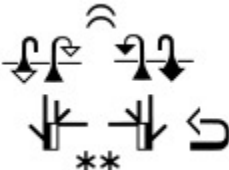

American Sign Language (ASL) Dictionary

Unedited 08082023

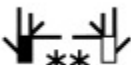
Spoken Word	SignWriting
Connecticut	
conscience	
consider	
consider	
consider	
consideration	
consistent	
CONSTANCY	
constant	
constitution	



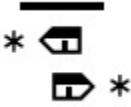

American Sign Language (ASL) Dictionary

Unedited 08082023

Spoken Word	SignWriting
constitution	
contact	
contact	
contact	
contact	*
contact	
contacts	
container	
container	
contemplation	
contended	

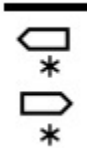
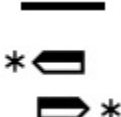

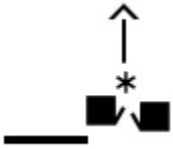
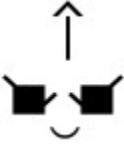

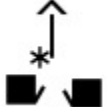
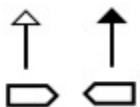

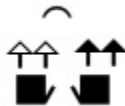

American Sign Language (ASL) Dictionary

Unedited 08082023

Spoken Word	SignWriting
contended	
content	
contented	
continual	
continue	
continue	
continue	
continue	
continue	

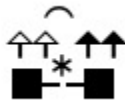

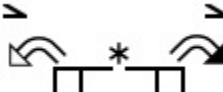



American Sign Language (ASL) Dictionary

Unedited 08082023

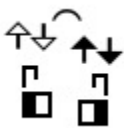
Spoken Word	SignWriting
continue	
continue	
continue indefinitely	
continue-indefinitely	
continuous	
continuously-broke	
contract	
contray	
contribution	

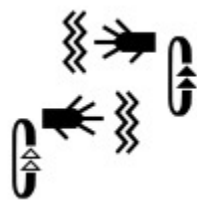

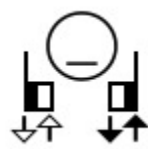



American Sign Language (ASL) Dictionary

Unedited 08082023

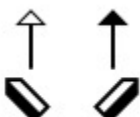
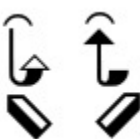
Spoken Word	SignWriting
control	
controversy	
convection	
Convection	
conversation	
convict	







American Sign Language (ASL) Dictionary

Unedited 08082023

Spoken Word	SignWriting
convince	
convince	
cook	
cook	
cookie	
cookie	
cookie	
cookie	

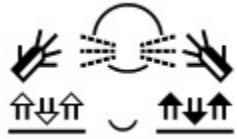







American Sign Language (ASL) Dictionary

Unedited 08082023

Spoken Word	SignWriting
cookie	
cooking	
cool	
cool	
cool	
cool	
cool	
cool	

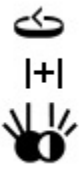

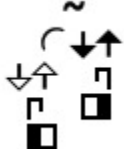

American Sign Language (ASL) Dictionary

Unedited 08082023

Spoken Word	SignWriting
cool	
cool	
cool	
cool	
cooperate	
coordinate	
coordinate	
coordinated	
coordinator	

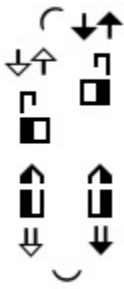

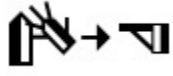

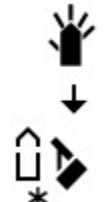
American Sign Language (ASL) Dictionary

Unedited 08082023

Spoken Word	SignWriting
coordinator	 <p>The signwriting consists of a circular arrow at the top, followed by a hand with fingers spread and a plus sign, then two vertical rectangles with arrows pointing up and down, and a closing parenthesis at the bottom.</p>
coordinator	 <p>The signwriting consists of a circular arrow at the top, followed by a hand with fingers spread and a plus sign, then two vertical rectangles with arrows pointing up and down, and a closing parenthesis at the bottom.</p>
coordinator	 <p>The signwriting consists of a circular arrow at the top, followed by a hand with fingers spread and a plus sign.</p>
cop	 <p>The signwriting consists of a vertical line, a circle with a dot inside, and two asterisks below it.</p>
copy	 <p>The signwriting consists of a hand with fingers spread, an arrow pointing right, and a vertical rectangle.</p>
copy	 <p>The signwriting consists of a hand with fingers spread, a circle with a dot inside, an arrow pointing right, and a vertical rectangle.</p>
copy	 <p>The signwriting consists of a hand with fingers spread, an arrow pointing right, a vertical rectangle with an arrow pointing right, and an asterisk below it.</p>

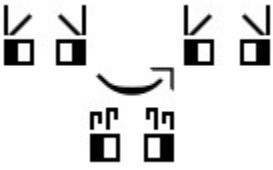

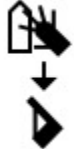

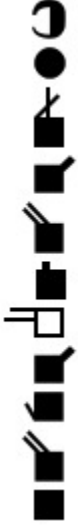

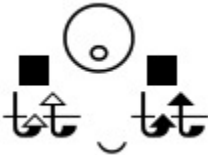
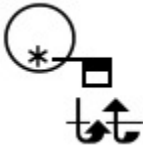

American Sign Language (ASL) Dictionary

Unedited 08082023

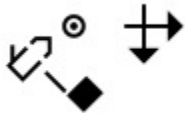
Spoken Word	SignWriting
copy & paste	
copy me	
copy you	
copy-me	
copy-me	
Corinthians	









American Sign Language (ASL) Dictionary

Unedited 08082023

Spoken Word	SignWriting
corn	
corn	
corn	
corner	
correct	
correct	
cosmetics	
cost	
couch	 

American Sign Language (ASL) Dictionary

Unedited 08082023

Spoken Word	SignWriting
couch	
couch	
couch	
cough	
cough	
cough	
cough	
could	









American Sign Language (ASL) Dictionary

Unedited 08082023

Spoken Word	SignWriting
could	<p>The SignWriting for 'could' consists of a circle with two short horizontal lines inside, representing the mouth. Below this are two sets of horizontal bars, each with a downward-pointing arrow underneath, representing the hands.</p>
counselor	<p>The SignWriting for 'counselor' features a vertical sequence of symbols: a hand with fingers spread, an upward arrow, a circle with a dot, a triangle, and a rectangle. At the bottom, there are two vertical bars, each with a downward arrow.</p>
count	<p>The SignWriting for 'count' shows a hand with fingers spread, with two upward arrows above it and a solid black circle below it.</p>
count	<p>The SignWriting for 'count' includes a hand with fingers spread, a circle with a dot, and an upward arrow.</p>
count	<p>The SignWriting for 'count' shows a hand with fingers spread, a circle with a dot, and two upward arrows.</p>
count	<p>The SignWriting for 'count' features a hand with fingers spread, a circle with a dot, and an upward arrow. Below this is a wavy line with an upward arrow, and a separate diamond shape.</p>





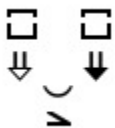

American Sign Language (ASL) Dictionary

Unedited 08082023

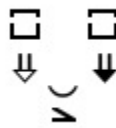
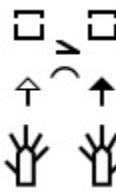
Spoken Word	SignWriting
count	
Count	
counter	
Countess	
country	
country	
country	
country	
courage	



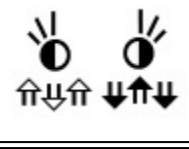

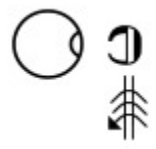

American Sign Language (ASL) Dictionary

Unedited 08082023

Spoken Word	SignWriting
courageous	
courageous	
course	
course	
court	
court	
courteous	
courteous	
cousin	



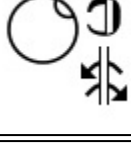

American Sign Language (ASL) Dictionary

Unedited 08082023

Spoken Word	SignWriting
cousin	
cousin	
cousin	
cousin	
cousin-female	
cousin-male	
cousin-male	
cover	

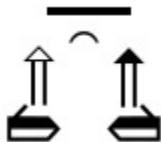
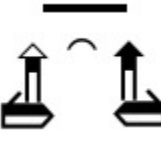
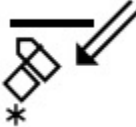

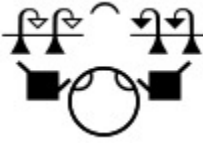



American Sign Language (ASL) Dictionary

Unedited 08082023

Spoken Word	SignWriting
cover	
cover	
cover-heart	
cow	
cow	
cow	
cow	
cow	
coward	









American Sign Language (ASL) Dictionary

Unedited 08082023

Spoken Word	SignWriting
Coyote	
Coyote character licks lips while on motorcycle	
coyote character name	
coyote teeth description	
crab	
crab	
crab	



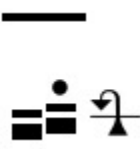



American Sign Language (ASL) Dictionary

Unedited 08082023

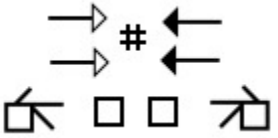
Spoken Word	SignWriting
crab	
crab	
crab	
crack	
cracker	
cracker	
cramp	
cramps	

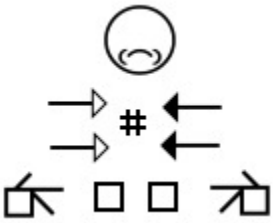

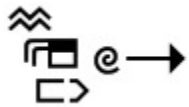



American Sign Language (ASL) Dictionary

Unedited 08082023

Spoken Word	SignWriting
crap	
crash	
crash	
crash-sad	
crawl	
crawl-in-bed	
crawling	
crayon	

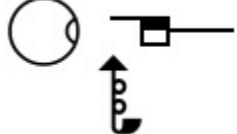

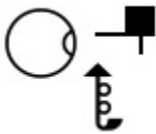

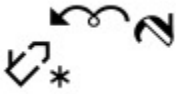



American Sign Language (ASL) Dictionary

Unedited 08082023

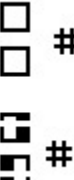
Spoken Word	SignWriting
Crazy	
crazy	
crazy	
crazy	
crazy	
crazy for	
crazy-L	
cream	
cream	



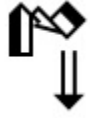

American Sign Language (ASL) Dictionary

Unedited 08082023

Spoken Word	SignWriting
cream	
create	
create	
create	
create	
creativity	
credit card	
credit card	

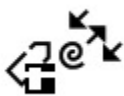

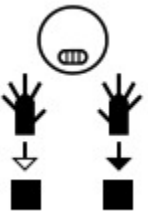
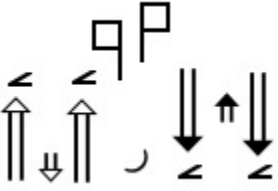
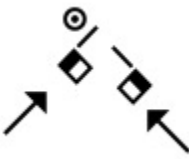
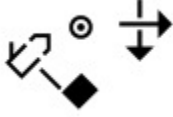
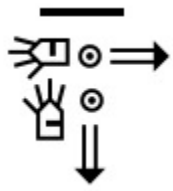



American Sign Language (ASL) Dictionary

Unedited 08082023

Spoken Word	SignWriting
credit card	
credit card test	
cringe	
crippled	
crisis	
criticize	
Croatia	
crocodile	

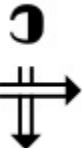

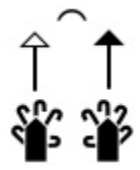
American Sign Language (ASL) Dictionary

Unedited 08082023

Spoken Word	SignWriting
crocodile	
Crooked	
cross	
cross-your-heart	
crossroads	
crowd	
crowd-look-at-me	





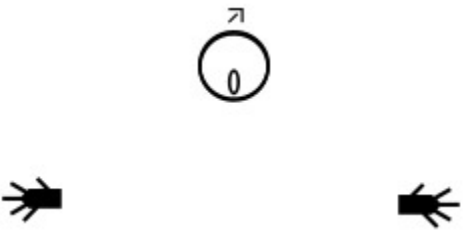

American Sign Language (ASL) Dictionary

Unedited 08082023

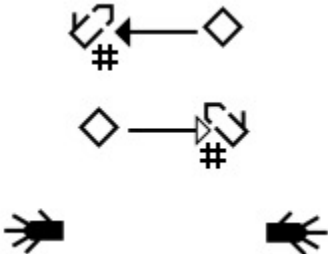
Spoken Word	SignWriting
crowd-look-at-you	
crowded	
crown	
crucified	



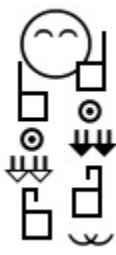



American Sign Language (ASL) Dictionary

Unedited 08082023

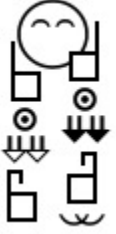
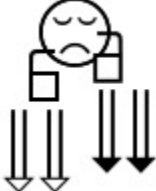
Spoken Word	SignWriting
crucify	
crumble paper	
crumple paper	
crunch	
cry	
cry	







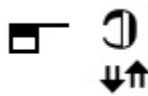

American Sign Language (ASL) Dictionary

Unedited 08082023

Spoken Word	SignWriting
cry	
cry and cry	
Cuba	
Cuba	
cube	
cube	
cube	



American Sign Language (ASL) Dictionary

Unedited 08082023

Spoken Word	SignWriting
cucumber	
Cued Speech	
culture	
cup	
cup	
cup	
cup	
cupboard	
curcuit	
curious	

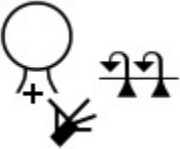
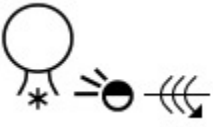
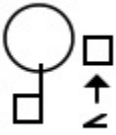
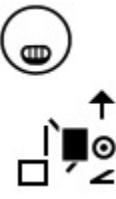
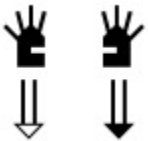

American Sign Language (ASL) Dictionary

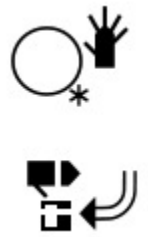
Unedited 08082023

Spoken Word	SignWriting
curious	
Curious	
curse	
curse	
curtain	
curtains	
custody	

American Sign Language (ASL) Dictionary

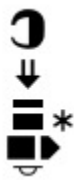
Unedited 08082023

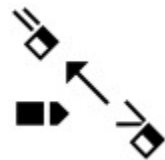
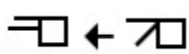
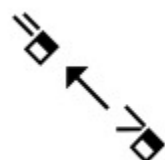
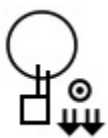
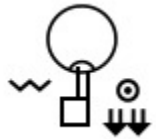
Spoken Word	SignWriting
custom	
custom	
cut	
cut	
cut	
cut with scissors	
cute	
cute	









American Sign Language (ASL) Dictionary

Unedited 08082023

Spoken Word	SignWriting
cute	
cycling	
cylinder	
Czech	
Czech	
Czech	
Czech	
Czechoslovakia	
Czechoslovakian	







American Sign Language (ASL) Dictionary

Unedited 08082023

Spoken Word	SignWriting
D	
D	
D	
DAC	
dad up left	
dad up right	
Dallas	
damned	
dance	

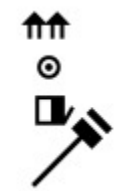
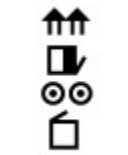



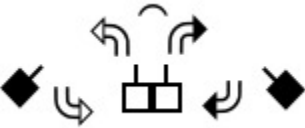

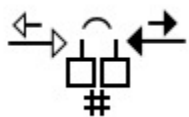

American Sign Language (ASL) Dictionary

Unedited 08082023

Spoken Word	SignWriting
dance	
dance	
danger	
danger	
danger	
Danish	
Danish	
Dar	
dare	



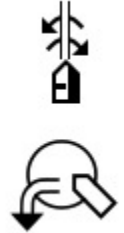



American Sign Language (ASL) Dictionary

Unedited 08082023

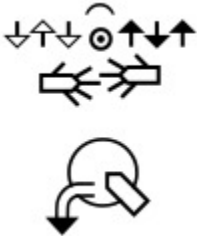
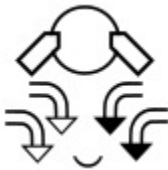
Spoken Word	SignWriting
dare	
dark	
dark	
dark	
dark	
dark	
dark blue	
dark green	





American Sign Language (ASL) Dictionary

Unedited 08082023

Spoken Word	SignWriting
dark grey	
dark night	
dark yellow	
Darline Clark-Gunsauls	
darn	
DAS Sign	
dash	
date	
date	

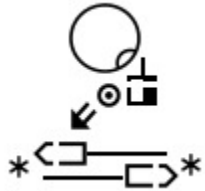

American Sign Language (ASL) Dictionary

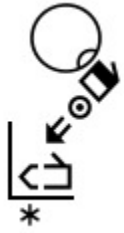
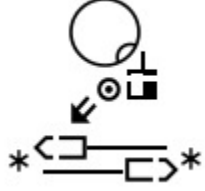
Unedited 08082023

Spoken Word	SignWriting
date	
daughter	
daughter	
daughter	
daughter	
daughter	



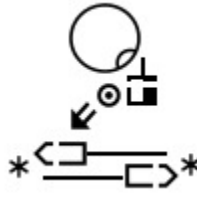

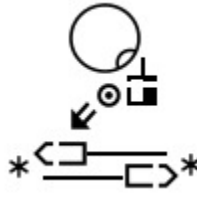
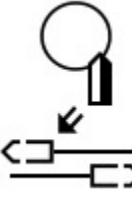
American Sign Language (ASL) Dictionary

Unedited 08082023

Spoken Word	SignWriting
daughter	
daughter	
daughter	
daughter	
daughter	

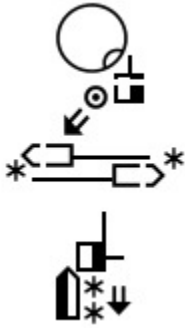

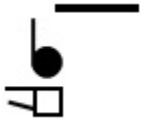

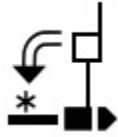
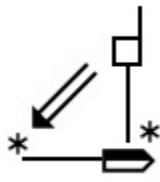
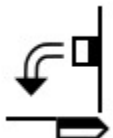
American Sign Language (ASL) Dictionary

Unedited 08082023

Spoken Word	SignWriting
daughter-in-law	 <p>The SignWriting symbol for 'daughter-in-law' consists of two parts. The top part shows a circle with a dot inside, connected by an arrow to a square with a dot inside, which is then connected to a horizontal line with arrows at both ends. The bottom part shows a square with a dot inside, connected to a horizontal line with arrows at both ends, and a vertical line with a dot at the top.</p>
Dave Gunsauls	 <p>The SignWriting symbol for 'Dave Gunsauls' consists of a vertical line with a dot at the top, connected to a square with a dot inside, which is then connected to a horizontal line with arrows at both ends.</p>
Dave Gunsauls	 <p>The SignWriting symbol for 'Dave Gunsauls' consists of a vertical line with a dot at the top, connected to a square with a dot inside, which is then connected to a horizontal line with arrows at both ends.</p>
David	 <p>The SignWriting symbol for 'David' consists of a vertical line with a dot at the top, connected to a square with a dot inside, which is then connected to a horizontal line with arrows at both ends.</p>
day	 <p>The SignWriting symbol for 'day' consists of a vertical line with a dot at the top, connected to a square with a dot inside, which is then connected to a horizontal line with arrows at both ends.</p>
day	 <p>The SignWriting symbol for 'day' consists of a vertical line with a dot at the top, connected to a square with a dot inside, which is then connected to a horizontal line with arrows at both ends.</p>
day	 <p>The SignWriting symbol for 'day' consists of a vertical line with a dot at the top, connected to a square with a dot inside, which is then connected to a horizontal line with arrows at both ends.</p>

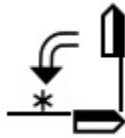
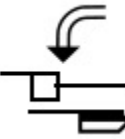

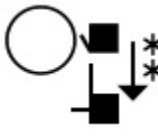
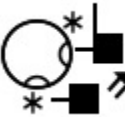
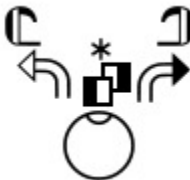

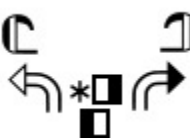

American Sign Language (ASL) Dictionary

Unedited 08082023

Spoken Word	SignWriting
day	
day	
day after tomorrow	
day before yesterday	
day before yesterday	
daydream	
daydream	
daydream	

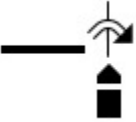
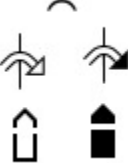
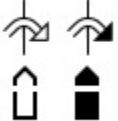







American Sign Language (ASL) Dictionary

Unedited 08082023

Spoken Word	SignWriting
DC	
dead	
dead	
dead	
dead	
deaf	
deaf	
deaf	







American Sign Language (ASL) Dictionary

Unedited 08082023

Spoken Word	SignWriting
deaf	
deaf	
deaf	
deaf	
deaf	
deaf	
Deaf	
Deaf	
Deaf	



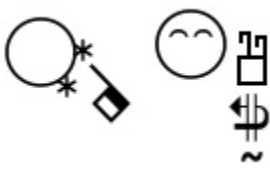



American Sign Language (ASL) Dictionary

Unedited 08082023

Spoken Word	SignWriting
Deaf	
Deaf	
Deaf church	
Deaf Unity	
deaf-power	
deaf-school	
deafblind	
deafblind	



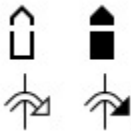

American Sign Language (ASL) Dictionary

Unedited 08082023

Spoken Word	SignWriting
dealing cards	
dealing cards	
dear	
dear	
dearest	
death	
debate	
debate	

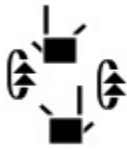

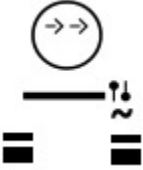

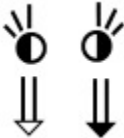
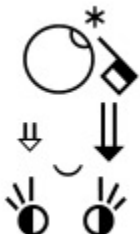
American Sign Language (ASL) Dictionary

Unedited 08082023

Spoken Word	SignWriting
deceit	
deceive	
decelerate motorcycle	
December	
deception	
decide	
decide	

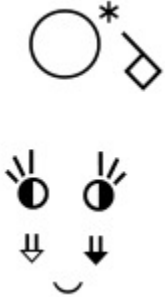

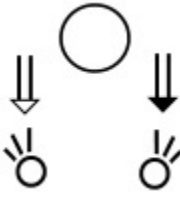

American Sign Language (ASL) Dictionary

Unedited 08082023

Spoken Word	SignWriting
decide	
deciduous	
decipher	
decision	
declaration	
declare	
decline	

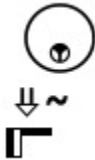
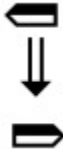







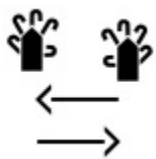

American Sign Language (ASL) Dictionary

Unedited 08082023

Spoken Word	SignWriting
decorating	
decrease	
decrease	
decrease	
decrease	
dedicate-to-God	
deduct	

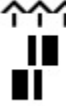





American Sign Language (ASL) Dictionary

Unedited 08082023

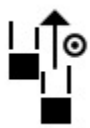
Spoken Word	SignWriting
deed	
deep	
deep	
deer	
deer	
defecate	
defend	
defense	
defense	
defer	



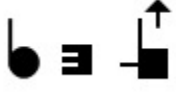





American Sign Language (ASL) Dictionary

Unedited 08082023

Spoken Word	SignWriting
deflated-esteem	
defraud	
degrade	
degree	
degree of temperature	
Delaware	
Delaware	
delay	









American Sign Language (ASL) Dictionary

Unedited 08082023

Spoken Word	SignWriting
DELAY	
delegs	
delete	
delete	
delete	
delete	
delete	
delicious	

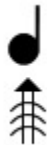



American Sign Language (ASL) Dictionary

Unedited 08082023

Spoken Word	SignWriting
delicious	
deliver	
demand	
democracy	
democrat	
Democrat	
demon	
demonstrate	







American Sign Language (ASL) Dictionary

Unedited 08082023

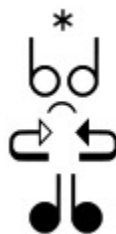
Spoken Word	SignWriting
demonstrate	
Denmark	
Denmark	
Denmark	

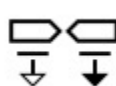
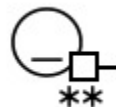





American Sign Language (ASL) Dictionary

Unedited 08082023

Spoken Word	SignWriting
denomination	
denomination	
dent	
dentist	
dentist	
dentist	
dentist	
Denver	

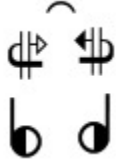
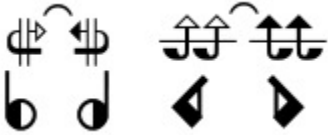
American Sign Language (ASL) Dictionary

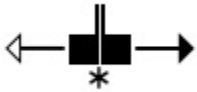
Unedited 08082023

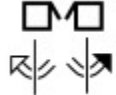
Spoken Word	SignWriting
deny	
Deodorant	
department	
department-store	
department2	
departure	
depend	
deplete	
deposit	



American Sign Language (ASL) Dictionary

Unedited 08082023

Spoken Word	SignWriting
deposit	<p>The signwriting for 'deposit' consists of two main components. The first is a square with a horizontal line above it, with a downward arrow pointing from the line to the square. The second is a square with a vertical line to its left, with a rightward arrow pointing from the line to the square. These two components are arranged in a 2x2 grid.</p>
depressed	<p>The signwriting for 'depressed' features a sad face (a circle with a downward-curving mouth) at the top. Below it are two hands, each with fingers spread, positioned on either side. At the bottom, there are two downward-pointing arrows, one under each hand.</p>
depressed	<p>The signwriting for 'depressed' features a sad face at the top. Below it are two hands, each with fingers spread, positioned on either side. At the bottom, there are two downward-pointing arrows, one under each hand, with a small upward-curving smile between them.</p>
depressed	<p>The signwriting for 'depressed' features a sad face at the top. Below it are two hands, each with fingers spread, positioned on either side. At the bottom, there are two downward-pointing arrows, one under each hand, with a small upward-curving smile between them.</p>
depression	<p>The signwriting for 'depression' features a sad face with a horizontal line through it at the top. Below it are two hands, each with fingers spread, positioned on either side. At the bottom, there are two downward-pointing arrows, one under each hand, with a small upward-curving smile between them.</p>
depression	<p>The signwriting for 'depression' features a sad face with a horizontal line through it at the top. Below it are two hands, each with fingers spread, positioned on either side. At the bottom, there are two downward-pointing arrows, one under each hand.</p>

American Sign Language (ASL) Dictionary

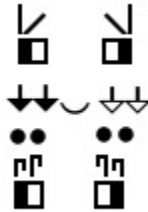
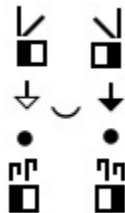
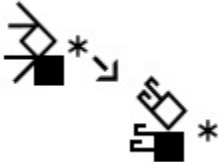
Unedited 08082023

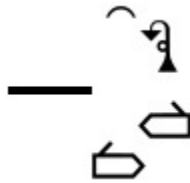
Spoken Word	SignWriting
depression	
derivation	
derive	
derive	
derive	
descendants	







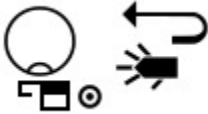

American Sign Language (ASL) Dictionary

Unedited 08082023

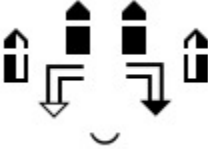
Spoken Word	SignWriting
describe	<p>The SignWriting for 'describe' consists of three main components: a curved arrow pointing left at the top left, a vertical line with a downward arrow at the bottom left, and a circular arrow pointing right at the bottom right. A separate vertical line with an upward arrow is positioned at the top right.</p>
describe	<p>This SignWriting is identical to the one above, showing a curved arrow pointing left, a vertical line with a downward arrow, a circular arrow pointing right, and a vertical line with an upward arrow.</p>
describe a small circular object	<p>The SignWriting for 'describe a small circular object' features a solid black square on the left and a square with a circle inside on the right. A curved arrow points from the circle towards the right.</p>
describe bike seat shape	<p>The SignWriting for 'describe bike seat shape' includes two solid black squares at the top, with two curved arrows pointing downwards from each square towards the center.</p>
describe handlebars	<p>The SignWriting for 'describe handlebars' shows two curved arrows pointing outwards from a central point, with two solid black squares positioned below the arrows.</p>
describe motorcycle tank	<p>The SignWriting for 'describe motorcycle tank' features a horizontal line at the top, two curved arrows pointing downwards from the line, a central asterisk, and a vertical arrow pointing downwards from the asterisk.</p>
desert	<p>The SignWriting for 'desert' consists of a circle at the top, a square with a circle inside below it, and a vertical arrow pointing right from the square. Below these are two solid black squares with curved arrows pointing upwards from each.</p>

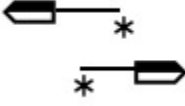



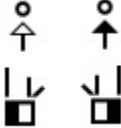

American Sign Language (ASL) Dictionary

Unedited 08082023

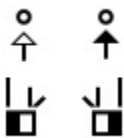
Spoken Word	SignWriting
desert	
Design	
desk	
desk	
desk	
desk	
desk	
desk	
desk	
despise	

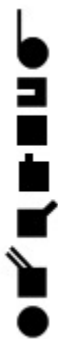





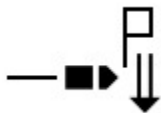

American Sign Language (ASL) Dictionary

Unedited 08082023

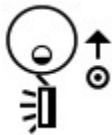
Spoken Word	SignWriting
despised	
dessert	
Destino	
destroy	
destroy	
destroy fast	

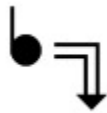



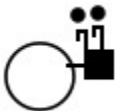

American Sign Language (ASL) Dictionary

Unedited 08082023

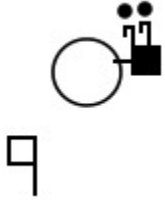
Spoken Word	SignWriting
detail	
detective	
detest	
Detroit	
Detroit, Michigan	
develop	
develop	
develop	
Devil	

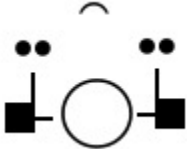







American Sign Language (ASL) Dictionary

Unedited 08082023

Spoken Word	SignWriting
devil	
devil	
devil	
Devil - Benedictine	
devil3	
devil4	
dia	

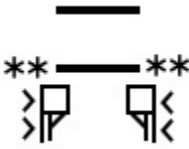
American Sign Language (ASL) Dictionary

Unedited 08082023

Spoken Word	SignWriting
dialogue	
diamond	
diamond	
diamond	
diaper	
diaper	
diarrhea	
diarrhea	
dice	

American Sign Language (ASL) Dictionary

Unedited 08082023

Spoken Word	SignWriting
dice	
dictionary	
did	
did you say?	
didn't say that	
die	
dieta high carb	



American Sign Language (ASL) Dictionary

Unedited 08082023

Spoken Word	SignWriting
different	<p>The sign is composed of two diamond shapes with an 'X' between them. Above the diamonds are two pairs of arrows pointing left and right, each with a curved arrow above it indicating a specific movement.</p>
different	<p>The sign features two diamond shapes with an 'X' between them. Above them are two pairs of arrows pointing left and right, with a curved arrow above the right pair.</p>
different	<p>The sign starts with a circle containing a hand symbol. Below it are two diamond shapes with an 'X' between them. At the bottom are two pairs of arrows pointing left and right, with a central vertical line and a downward arrow.</p>
different	<p>The sign consists of two diamond shapes with an 'X' between them. On the far left and right are single arrows pointing left and right respectively.</p>
different	<p>The sign has two diamond shapes with an 'X' between them. Above them are two pairs of arrows pointing left and right, each with a curved arrow above it. Below the diamonds is another pair of arrows pointing left and right.</p>
different	<p>The sign features two diamond shapes with an 'X' between them. Above them are two pairs of arrows pointing left and right, with a curved arrow above the right pair.</p>
different	<p>The sign starts with a hand symbol on the left and right. In the center are two diamond shapes with an 'X' between them and a curved arrow below them.</p>
different	<p>The sign has two diamond shapes with an 'X' between them. Below them are two pairs of arrows pointing left and right, with a central vertical line and a downward arrow.</p>

American Sign Language (ASL) Dictionary

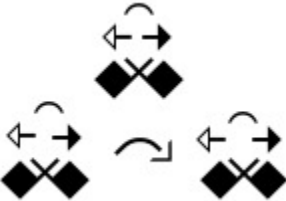
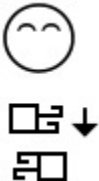
Unedited 08082023

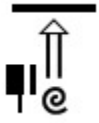
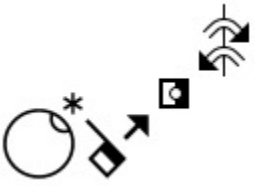
Spoken Word	SignWriting
different	
different	
difficult	
difficult	
diffusion	
dignity	
dime	







American Sign Language (ASL) Dictionary

Unedited 08082023

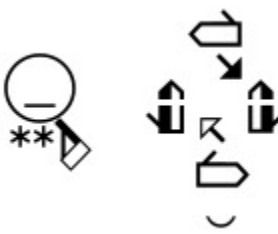
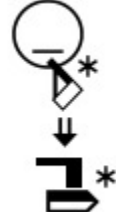
Spoken Word	SignWriting
dining room	 The SignWriting symbol for 'dining room' consists of a circle at the top, a star below it, and a table with two chairs below that. The table is represented by a horizontal line with two vertical lines extending downwards from it, and the chairs are represented by two vertical lines with small curved tops. The entire symbol is centered within the SignWriting cell.







American Sign Language (ASL) Dictionary

Unedited 08082023

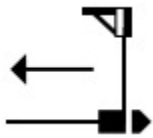
Spoken Word	SignWriting
dining-room	
dinner	
dinner	
dinner	
dinner	
dinner	
dinner	



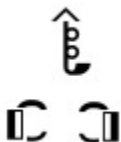
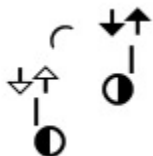

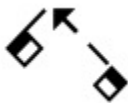

American Sign Language (ASL) Dictionary

Unedited 08082023

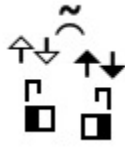
Spoken Word	SignWriting
dinosaur	
dinosaur	
dip	
diploma	
dipping	
direction	
directly	
directly	



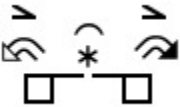
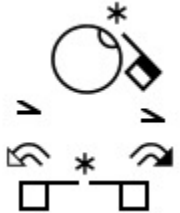

American Sign Language (ASL) Dictionary

Unedited 08082023

Spoken Word	SignWriting
director	
dirt	
dirty	
dirty	
disability	
disagree	
disagree	
disappear	

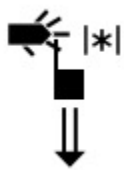

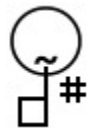
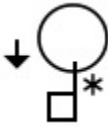
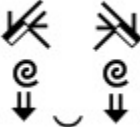



American Sign Language (ASL) Dictionary

Unedited 08082023

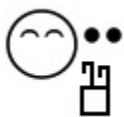
Spoken Word	SignWriting
disappear	
disappear	
disappearing into the distance down a cliff	
disappoint	
disappointed	
disappointed	
disbelief	



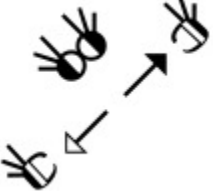
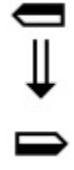
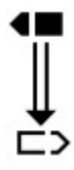



American Sign Language (ASL) Dictionary

Unedited 08082023

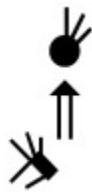
Spoken Word	SignWriting
disbelief	
discard	
disciple	
discipline	
disconnect	
discount	
discount	
discouraged	





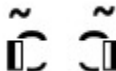

American Sign Language (ASL) Dictionary

Unedited 08082023

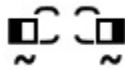
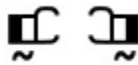
Spoken Word	SignWriting
discover	
discuss	
discuss	
discuss	
disease	
DISFELLOWSHIP	
disgust	
dish	



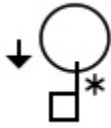



American Sign Language (ASL) Dictionary

Unedited 08082023

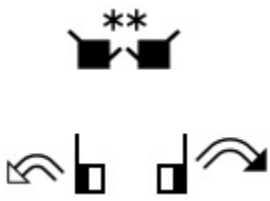
Spoken Word	SignWriting
dishes	
disk	
disk, with depth	
Disneyland	
Disperse	
display	
dispute	
dissapointed	
dissolve	
dissolve	



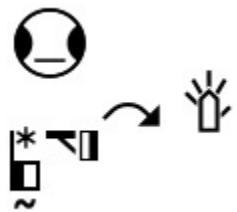

American Sign Language (ASL) Dictionary

Unedited 08082023

Spoken Word	SignWriting
distance (measuring distance apart)	
distant future	
distaste-for	
distraction	
distribute-to	
disturb	
dive	

American Sign Language (ASL) Dictionary

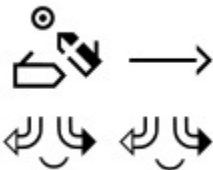
Unedited 08082023

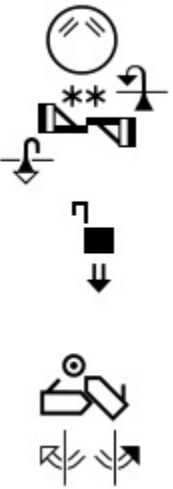
Spoken Word	SignWriting
dive in	
diver	
diversity	
divide	
divide-2	
dividend	







American Sign Language (ASL) Dictionary

Unedited 08082023

Spoken Word	SignWriting
divine-help	<p>The SignWriting for 'divine-help' consists of a vertical sequence of symbols: a hand with the index finger pointing down, a hand with the index finger pointing down, a hand with the index finger pointing up, a square with an upward-pointing arrow, an asterisk, and a square with an upward-pointing arrow.</p>
division	<p>The SignWriting for 'division' consists of a hand with the index finger pointing down, a hand with the index finger pointing down, and two vertical lines with arrows pointing outwards from the center.</p>
divisor	<p>The SignWriting for 'divisor' consists of two columns of symbols. The left column has a hand with the index finger pointing down, two vertical lines with arrows pointing outwards, two hands with fingers pointing towards each other, and two circles. The right column has a hand with the index finger pointing down, two vertical lines with arrows pointing outwards, two hands with fingers pointing towards each other, and two circles. Below these columns is a hand with the index finger pointing down, a circle with two horizontal lines inside, and two hands with fingers pointing towards each other.</p>
divorce	<p>The SignWriting for 'divorce' consists of two circles, a hand with the index finger pointing down, an asterisk, and a hand with the index finger pointing down.</p>
divorce	<p>The SignWriting for 'divorce' consists of a hand with the index finger pointing up, a hand with the index finger pointing down, a hand with the index finger pointing down, a hand with the index finger pointing down, a hand with the index finger pointing down, a hand with the index finger pointing down, and a hand with the index finger pointing down.</p>

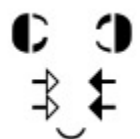

American Sign Language (ASL) Dictionary

Unedited 08082023

Spoken Word	SignWriting
divorce	
divorce	
divorce	
dizzy	
DLE 201	
DLE 201	
DLE 201	
do	
do	
do	

American Sign Language (ASL) Dictionary

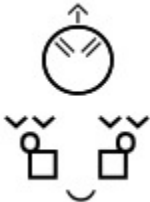
Unedited 08082023

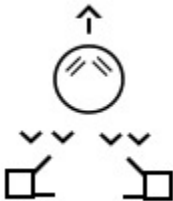
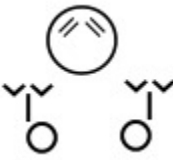
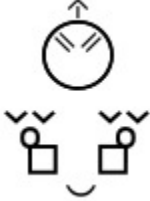
Spoken Word	SignWriting
do	
do	
do	
do	
do	
do do	

American Sign Language (ASL) Dictionary

Unedited 08082023

Spoken Word	SignWriting
do errands	
do errands	
do laundry	
do not know	
do not know	
do not want	



American Sign Language (ASL) Dictionary

Unedited 08082023

Spoken Word	SignWriting
do not want	
do not want	
Do you love me?	
Do you love me?	





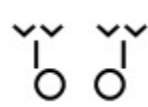
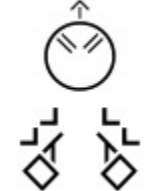
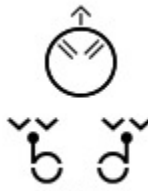
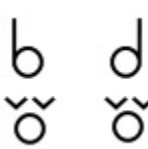
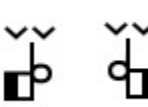



American Sign Language (ASL) Dictionary

Unedited 08082023

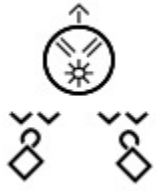
Spoken Word	SignWriting
do you mind?	
do you mind?	
do-do	
do-do	
do-do	
do-do?	
do-do?	
do-do?	







American Sign Language (ASL) Dictionary

Unedited 08082023

Spoken Word	SignWriting
do-not	
do-not-like	
do?	
do_not_know	
doctor	
doctor	
doctor	
doctor	



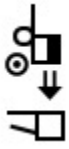



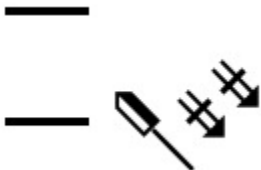

American Sign Language (ASL) Dictionary

Unedited 08082023

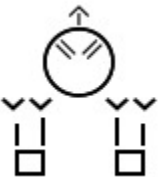
Spoken Word	SignWriting
Doente	
dog	
dog	
dog	
dog	
dog	
dog	
dog bark	

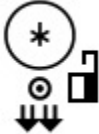







American Sign Language (ASL) Dictionary

Unedited 08082023

Spoken Word	SignWriting
dog petting	
doing on an outing	
doing?	
Doja	
doll	
dollar	
dollar	
dollar	
dolphin	

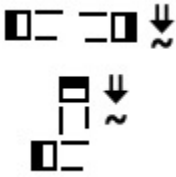
American Sign Language (ASL) Dictionary

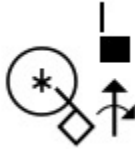
Unedited 08082023

Spoken Word	SignWriting
dolphin	
dom	
domingo	
domino effect	
dominoes	
Don Bosco	
don't	
don't care	
don't care	

American Sign Language (ASL) Dictionary

Unedited 08082023

Spoken Word	SignWriting
don't do that	<p>The signwriting consists of three parts: a circle with a hand icon and an arrow pointing up and to the right, a small black square, and a vertical line with three horizontal tick marks at the bottom and an arrow pointing down and to the right.</p>
don't know	<p>The signwriting consists of two parts: a circle with a hand icon and an arrow pointing up and to the right, and a hand icon with an arrow pointing up and to the right.</p>
don't like	<p>The signwriting consists of five parts: a circle with a hand icon and an arrow pointing up and to the right, a hand icon with an arrow pointing up and to the right, a hand icon with an arrow pointing up and to the right, a hand icon with an arrow pointing up and to the right, and a hand icon with an arrow pointing up and to the right.</p>
don't like	<p>The signwriting consists of five parts: a circle with a hand icon and an arrow pointing up and to the right, a hand icon with an arrow pointing up and to the right, a hand icon with an arrow pointing up and to the right, a hand icon with an arrow pointing up and to the right, and a hand icon with an arrow pointing up and to the right, followed by an asterisk.</p>





American Sign Language (ASL) Dictionary

Unedited 08082023

Spoken Word	SignWriting
<p style="text-align: center;">don't like</p>	<p>The signwriting for 'don't like' consists of five vertical elements: a circle with a hand arrow pointing clockwise, a hand with fingers spread, a hand with index finger pointing up, a hand with index finger pointing right, and a hand with index finger pointing up and thumb pointing right.</p>
<p style="text-align: center;">don't mind</p>	<p>The signwriting for 'don't mind' consists of two elements: a circle with a hand arrow pointing clockwise and a hand with index finger pointing up.</p>
<p style="text-align: center;">don't mind</p>	<p>The signwriting for 'don't mind' consists of two elements: a circle with a hand arrow pointing clockwise and an asterisk, followed by a hand with index finger pointing up.</p>
<p style="text-align: center;">don't understand</p>	<p>The signwriting for 'don't understand' consists of two elements: a circle with a hand arrow pointing clockwise and a hand with index finger pointing up.</p>
<p style="text-align: center;">don't want</p>	<p>The signwriting for 'don't want' consists of two vertical columns of three elements each. The left column elements are: a hand with index finger pointing up, a hand with index finger pointing right, and a hand with index finger pointing up. The right column elements are: a hand with index finger pointing up, a hand with index finger pointing right, and a hand with index finger pointing up. A small crescent moon is positioned between the two columns.</p>

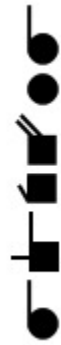

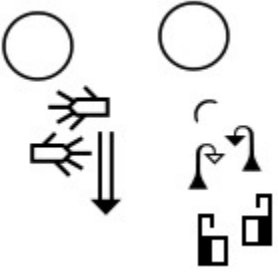

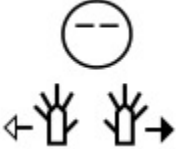

American Sign Language (ASL) Dictionary

Unedited 08082023

Spoken Word	SignWriting
Donald	
Donald Trump	
donate	
donate blood	
donation	
done	

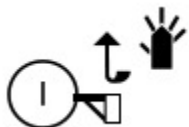

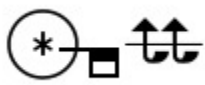



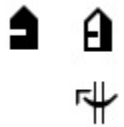

American Sign Language (ASL) Dictionary

Unedited 08082023

Spoken Word	SignWriting
donkey	
dont	
dont understand	
dont-care	
dont-like	
dont-mind	
door	
door	





American Sign Language (ASL) Dictionary

Unedited 08082023

Spoken Word	SignWriting
door	
door close	
door open	
doorbell	
dorm	
dormitory	
dot	
dotted-on-vertical	
double	



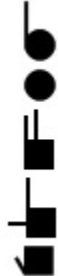

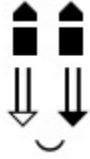
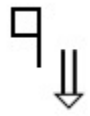
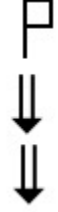

American Sign Language (ASL) Dictionary

Unedited 08082023

Spoken Word	SignWriting
doubt	
doubt	
doula	
down	
down	
down left	
down-down	

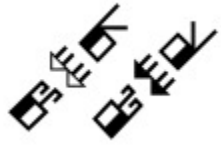
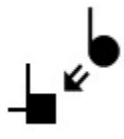
American Sign Language (ASL) Dictionary

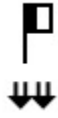
Unedited 08082023

Spoken Word	SignWriting
download	
download	
download	
download	
download-from-heaven	
downstairs	
downstairs	
Dr. William C. Stokoe, Jr.	

American Sign Language (ASL) Dictionary

Unedited 08082023

Spoken Word	SignWriting
drag king	<p>The signwriting for 'drag king' consists of two parts. The first part is a circle with a hand icon to its right, followed by a downward-pointing arrow and another hand icon. The second part is a hand icon positioned above a horizontal line, with another hand icon below it, and a vertical line extending downwards from the second hand icon.</p>
drag queen	<p>The signwriting for 'drag queen' consists of two parts. The first part is a circle with a hand icon to its right, followed by a downward-pointing arrow and another hand icon. The second part is a hand icon positioned above a horizontal line, with another hand icon below it, and a vertical line extending downwards from the second hand icon.</p>
dragged in	<p>The signwriting for 'dragged in' consists of a hand icon with a circle above it, followed by an upward-pointing arrow and a diamond shape.</p>
dragon	<p>The signwriting for 'dragon' consists of a hand icon with a circle above it containing a sun-like symbol, followed by a wavy line and an upward-pointing arrow.</p>
drama	<p>The signwriting for 'drama' consists of a hand icon with a curved line above it, followed by a hand icon with a curved line above it, and a hand icon with a circle below it.</p>
draw	<p>The signwriting for 'draw' consists of a hand icon with a curved line above it, followed by a hand icon with a curved line above it, and a hand icon with a curved line above it.</p>

American Sign Language (ASL) Dictionary

Unedited 08082023

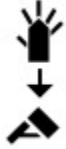
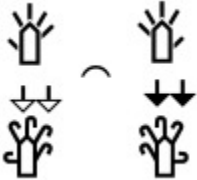
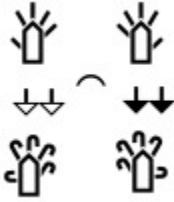
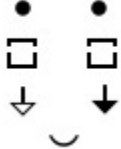
Spoken Word	SignWriting
draw	
draw cards	
drawer	
drawer	
drawer	









American Sign Language (ASL) Dictionary

Unedited 08082023

Spoken Word	SignWriting
drawing-water	
dread	
dreadful	
Dream	
dream	
dream	

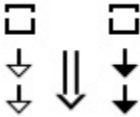
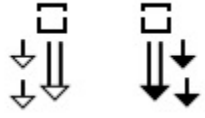

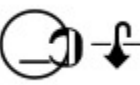

American Sign Language (ASL) Dictionary

Unedited 08082023

Spoken Word	SignWriting
dream	
dreaming	
dress	
dress	
dresser	
dresser	
drift	
drink	
drink	

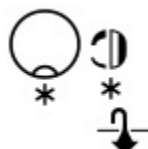
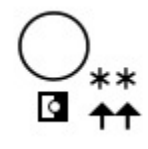
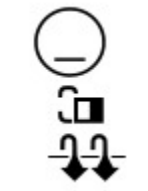

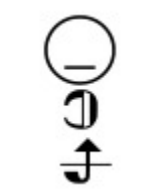
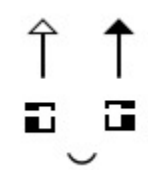
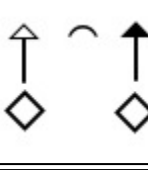

American Sign Language (ASL) Dictionary

Unedited 08082023

Spoken Word	SignWriting
drink	
drink	
drink	
drink	
drink	
drive	
drive	
drive	

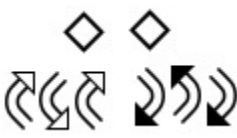

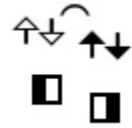
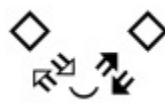

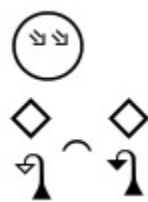
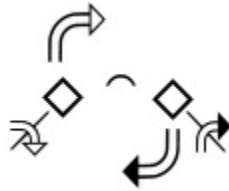

American Sign Language (ASL) Dictionary

Unedited 08082023

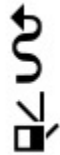
Spoken Word	SignWriting
drive	
drive	
drive	
drive	
drive	
drive for awhile	
drive here	
drive turn right	

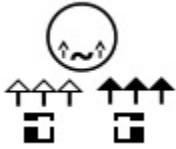
American Sign Language (ASL) Dictionary

Unedited 08082023

Spoken Word	SignWriting
drive vehicle	
drive-by	
drive-mm	
driver	
driver	
driver	
drool	







American Sign Language (ASL) Dictionary

Unedited 08082023

Spoken Word	SignWriting
drop	
drop	
drop	
drop out of school	
dropping-things	
drown	
DRUG	

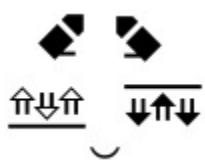
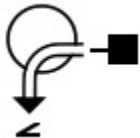
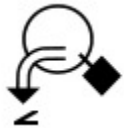





American Sign Language (ASL) Dictionary

Unedited 08082023

Spoken Word	SignWriting
drugs	
drugs	
drum	
drunk	
drunk	
drunk	
drunkard	
dry	
dry	

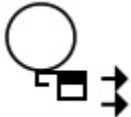
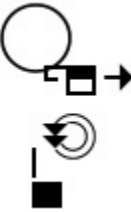

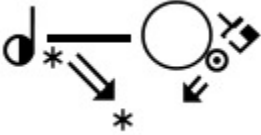
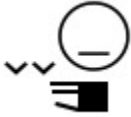



American Sign Language (ASL) Dictionary

Unedited 08082023

Spoken Word	SignWriting
dry	
dry	
dryer	
dryer	
dua	
Duchess	
duck	
duck	
due	

American Sign Language (ASL) Dictionary

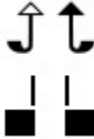
Unedited 08082023

Spoken Word	SignWriting
due	
Duke	
dull	
dumb	
dumb	
during	
during	
during	





American Sign Language (ASL) Dictionary

Unedited 08082023

Spoken Word	SignWriting
dusk	<p>The SignWriting for 'dusk' consists of a circle at the top, followed by a hand symbol with fingers spread, and a downward-pointing arrow.</p>
dust cloud	<p>The SignWriting for 'dust cloud' features a central circle with a hand symbol below it. Surrounding the circle are several smaller symbols, including a crescent moon and a hand with fingers spread.</p>
dust explosion at bottom of cliff	<p>The SignWriting for 'dust explosion at bottom of cliff' includes three circular symbols at the top, each with a downward arrow. Below them are three hand symbols with fingers spread, and a small square symbol at the bottom right.</p>
dust trail behind	<p>The SignWriting for 'dust trail behind' shows a circle at the top, followed by a hand symbol with fingers spread, and a small square symbol at the bottom right.</p>
dust trail forming behind distant object open mouth	<p>The SignWriting for 'dust trail forming behind distant object open mouth' features three circular symbols at the top, each with a rightward arrow. Below them are a hand symbol with fingers spread, a small square symbol, and a hand symbol with fingers spread.</p>

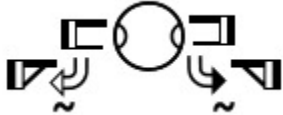
American Sign Language (ASL) Dictionary

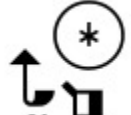
Unedited 08082023

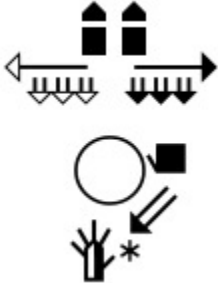
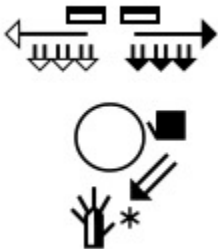
Spoken Word	SignWriting
Dutch	
Dutch	
dutch	
duties	
duty	
dwarfs	
dwarfs	





American Sign Language (ASL) Dictionary

Unedited 08082023

Spoken Word	SignWriting
dwell on	<p>The SignWriting for 'dwell on' consists of a circle with a dot inside, a hand with fingers spread, a hand with fingers spread and a star, a hand with fingers spread, and a hand with fingers spread.</p>
E	<p>The SignWriting for 'E' is a square with a vertical line on the right side.</p>
E	<p>The SignWriting for 'E' is a square with a vertical line on the right side and a horizontal line on the top side.</p>
each	<p>The SignWriting for 'each' consists of a square with a vertical line on the right side, a circle with a dot inside, and a hand with fingers spread.</p>
each	<p>The SignWriting for 'each' consists of a square with a vertical line on the right side, a circle with a dot inside, and a hand with fingers spread.</p>
each (singular) - right hand	<p>The SignWriting for 'each (singular) - right hand' consists of a square with a vertical line on the right side, a circle with a dot inside, and a hand with fingers spread.</p>
each (singular) left hand	<p>The SignWriting for 'each (singular) left hand' consists of a square with a vertical line on the right side, a circle with a dot inside, and a hand with fingers spread.</p>
each of three	<p>The SignWriting for 'each of three' consists of a square with a vertical line on the right side, a circle with a dot inside, a hand with fingers spread, and a hand with fingers spread.</p>

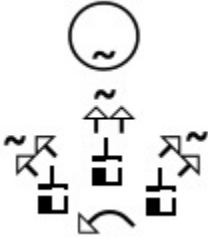
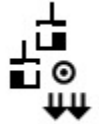
American Sign Language (ASL) Dictionary

Unedited 08082023

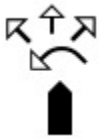
Spoken Word	SignWriting
each of you (left)	
each of yourselves - left hand	
each one	
each other	
each other	
each other - left hand primary	
each-of-yours	
each-of-yours-left	







American Sign Language (ASL) Dictionary

Unedited 08082023

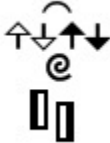
Spoken Word	SignWriting
eager	The SignWriting for 'eager' consists of two parts. The top part is a sequence of four arrows: an upward arrow, a downward arrow, an upward arrow, and a downward arrow. Below this sequence is a stylized icon of a house with a chimney on the right side. The house has a circular symbol above it, possibly representing a roof or a specific sign component.

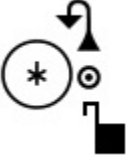

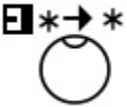
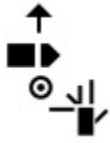





American Sign Language (ASL) Dictionary

Unedited 08082023

Spoken Word	SignWriting
eager	
eager	
eagle	
ear	
ear on head	
earl	
early	
early	

American Sign Language (ASL) Dictionary

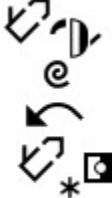
Unedited 08082023

Spoken Word	SignWriting
early facial	
early lexicalized	
early morning	
earn	
earn	
earn	
earn	
earn	





American Sign Language (ASL) Dictionary

Unedited 08082023

Spoken Word	SignWriting
earring	
earring	
earring	
ears	
ears perk up	
Earth	
earth	
earth	
earth	

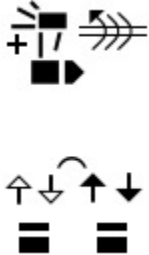
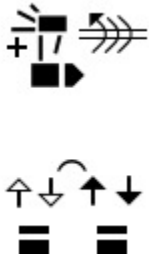
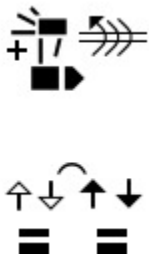







American Sign Language (ASL) Dictionary

Unedited 08082023

Spoken Word	SignWriting
earth	
Earthquake	
Earthquake	
earthquake	
east	
Easter	
Easter	





American Sign Language (ASL) Dictionary

Unedited 08082023

Spoken Word	SignWriting
easy	
easy	
eat	
eat	
eat	
eat	
eat words	
eat-a-lot	
eat-verb	

American Sign Language (ASL) Dictionary

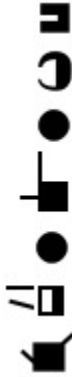
Unedited 08082023

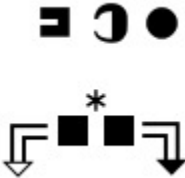
Spoken Word	SignWriting
eat-verb-left	
echo	
eco-friendly	
ecology	
Economics	
economy	
ecosystem	







American Sign Language (ASL) Dictionary

Unedited 08082023

Spoken Word	SignWriting
Ecumenicon	
edit	
edit	
education	
education	
education	
education	
Edward	



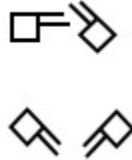



American Sign Language (ASL) Dictionary

Unedited 08082023

Spoken Word	SignWriting
ee mouth head tilt	
ee mth eyes squint	
egg	
egg	
egg	
egg	
egg	

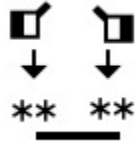

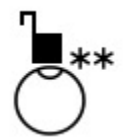

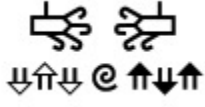

American Sign Language (ASL) Dictionary

Unedited 08082023

Spoken Word	SignWriting
egg	
eggs	
eggs	
egotistic	
Egypt	
Egypt	
Egyptian	
eh	



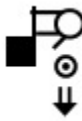
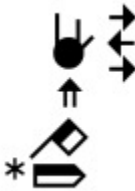

American Sign Language (ASL) Dictionary

Unedited 08082023

Spoken Word	SignWriting
Eid	
eight dollars	
eight hours	
eight minutes	
eight months	
eight o'clock	
eight of them	
eight of us	

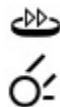
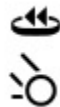
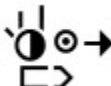



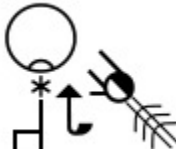
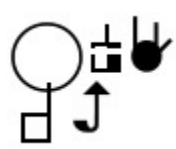
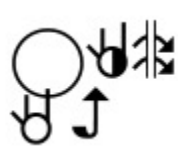

American Sign Language (ASL) Dictionary

Unedited 08082023

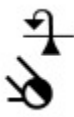
Spoken Word	SignWriting
eight of us (left hand)	
eight of us (right hand)	
eight weeks	
eight years old	
eight years old	
eight-of-us	
eighteen years old	
eighteen years old	
eighteen years old	

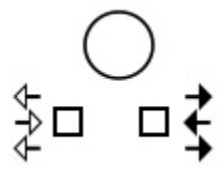

American Sign Language (ASL) Dictionary

Unedited 08082023

Spoken Word	SignWriting
eighth	
eighth (in a series) (left hand)	
eighty nine	
eighty seven	
eighty six	
either	
elaborate	
elastic	



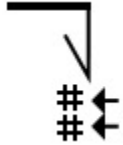

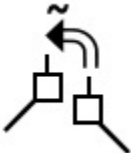

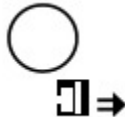

American Sign Language (ASL) Dictionary

Unedited 08082023

Spoken Word	SignWriting
elbow	
elbow slapping side	
elbow slapping side	
elder	





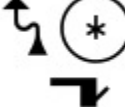

American Sign Language (ASL) Dictionary

Unedited 08082023

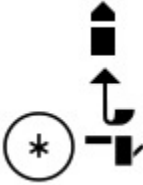
Spoken Word	SignWriting
elder	
election	
electric	
electric current	
electron	
element	
elementary	
elementary	
elephant	



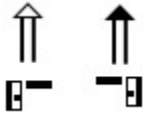

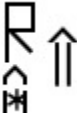

American Sign Language (ASL) Dictionary

Unedited 08082023

Spoken Word	SignWriting
elephant	
elephant	
elephant trunk	
elephant trunk	
elevate	
elevator	
elevator	
elevator	

American Sign Language (ASL) Dictionary

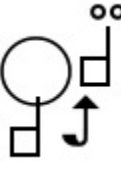
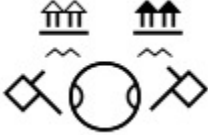
Unedited 08082023

Spoken Word	SignWriting
elevator	
eleven	
eleven	
eleven o'clock	
eleven years old	
eleven years old	
elf	
Ella	





American Sign Language (ASL) Dictionary

Unedited 08082023

Spoken Word	SignWriting
Elon	
elope	
Eloy	
email	
email	
email	
email	
email	





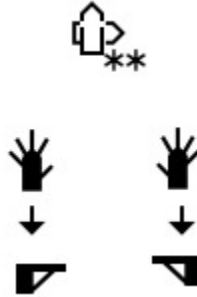

American Sign Language (ASL) Dictionary

Unedited 08082023

Spoken Word	SignWriting
Email to SignWriting List	
embarrass	
embarrass	
embarrassed	
embarrassed	
embedded	
embezzle	

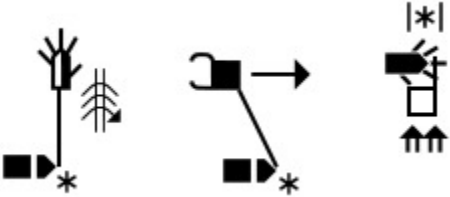

American Sign Language (ASL) Dictionary

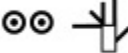
Unedited 08082023

Spoken Word	SignWriting
emergency	
emergency vehicle	
Emergent Layer	
emotion	
emotion	
emotion	
emotion	
emotion	



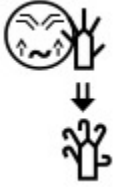
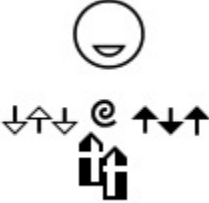

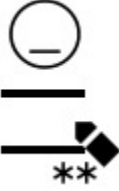
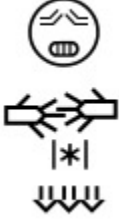
American Sign Language (ASL) Dictionary

Unedited 08082023

Spoken Word	SignWriting
Emotions	
Emotions	
Emotions	
Emotions	
Emotions	
Emotions	

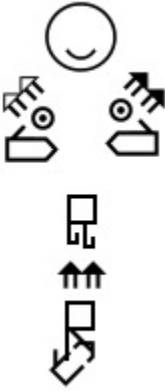
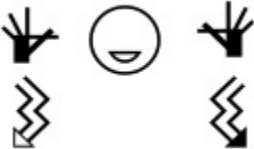

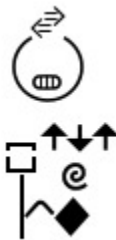
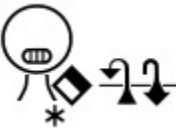



American Sign Language (ASL) Dictionary

Unedited 08082023

Spoken Word	SignWriting
Emotions	
Emotions	
Emotions	
Emotions	
Emotions	
empathy	

American Sign Language (ASL) Dictionary

Unedited 08082023

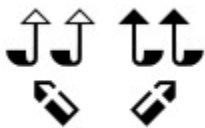
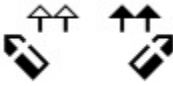
Spoken Word	SignWriting
emperor	
emphasis	
emphasize	
empire	
empty	
empty	
enable	
encourage	
encourage	





American Sign Language (ASL) Dictionary

Unedited 08082023

Spoken Word	SignWriting
encourage	
encourage	
Encyclopedia	
encyclopedia	
encyclopedia American Sign Language	
Encyclopedia, American Sign Language	
Encyclopedia, American Sign Language	
end	
end of thought	
end of vision	





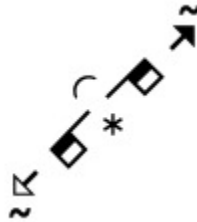
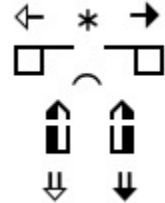
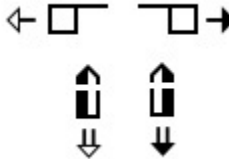



American Sign Language (ASL) Dictionary

Unedited 08082023

Spoken Word	SignWriting
endanger	
endure	
endure	
endure	
enemy	
enemy	
enemy	

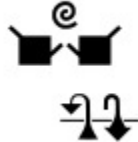
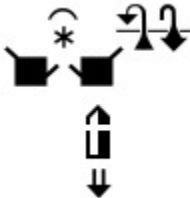



American Sign Language (ASL) Dictionary

Unedited 08082023

Spoken Word	SignWriting
energy	
engage	
engaged	
engine	
engineer	
engineer	
engineer	
engineering	
England	





American Sign Language (ASL) Dictionary

Unedited 08082023

Spoken Word	SignWriting
England	
England	
English	
English	
English	

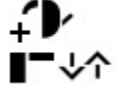
American Sign Language (ASL) Dictionary

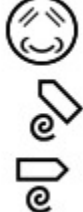
Unedited 08082023

Spoken Word	SignWriting
English	
english	
engineering	
enjoy	
enjoy	
enjoy	
Enjoy	









American Sign Language (ASL) Dictionary

Unedited 08082023

Spoken Word	SignWriting
Enjoy	<p>The SignWriting for 'Enjoy' consists of a smiling face icon at the top. Below it are two hand icons, each with a circular arrow around it, indicating a circular motion or rotation.</p>
enlighten	<p>The SignWriting for 'enlighten' is a vertical sequence of icons. At the top, two hand icons are shown with arrows pointing towards each other. Below this is a hand icon with a curved arrow. The middle part features a smiling face icon with a vertical line extending upwards from its forehead. At the bottom, there is a hand icon with a curved arrow.</p>
Enoch	<p>The SignWriting for 'Enoch' is a horizontal sequence of icons: a hand icon with an arrow pointing right, a solid black circle, a hand icon with an arrow pointing left, and a square icon.</p>
enough	<p>The SignWriting for 'enough' shows a hand icon with an arrow pointing up and right, a solid black circle, and a square icon.</p>
enough	<p>The SignWriting for 'enough' shows a hand icon with an arrow pointing up and right, a solid black circle, and a square icon.</p>
enough	<p>The SignWriting for 'enough' shows a hand icon with an arrow pointing up and right, a solid black circle, and a square icon.</p>
enough	<p>The SignWriting for 'enough' shows a large circle icon at the top, a hand icon with an arrow pointing right, and a square icon.</p>

American Sign Language (ASL) Dictionary

Unedited 08082023

Spoken Word	SignWriting
enter	
enter	
enter	
enthusiasm	
enthusiasm	
entice	
entire	
entire	
environment	









American Sign Language (ASL) Dictionary

Unedited 08082023

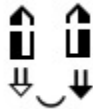
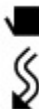
Spoken Word	SignWriting
envision	<p>The SignWriting for 'envision' consists of a circle with a horizontal line through its center. Above the circle, there are two hands: the left hand is open with fingers pointing left, and the right hand is open with fingers pointing right. Arrows point from the hands towards the circle.</p>
envy	<p>The SignWriting for 'envy' shows a hand with fingers pointing up and slightly right, positioned above a square. A circle is drawn around the hand and square.</p>
envy	<p>The SignWriting for 'envy' features a hand with fingers pointing up and right, positioned above a square. A circle is drawn around the hand and square, with a horizontal line through the center of the circle.</p>
Ephesians	<p>The SignWriting for 'Ephesians' is a vertical sequence of symbols: a hand with fingers pointing up and right, a diamond shape, a square, a hand with fingers pointing up and right, a hand with fingers pointing up and right, a hand with fingers pointing up and right, a hand with fingers pointing up and right, and a hand with fingers pointing up and right.</p>
epidemic	<p>The SignWriting for 'epidemic' shows a hand with fingers pointing up and right, positioned above a square. A circle is drawn around the hand and square, with a horizontal line through the center of the circle. Below this, there are two hands with fingers pointing up and right, positioned above a square. A horizontal line is drawn through the center of the square.</p>
equal	<p>The SignWriting for 'equal' consists of a hand with fingers pointing up and right, positioned above a square. A horizontal line is drawn through the center of the square. Below this, there are two hands with fingers pointing up and right, positioned above a square. A horizontal line is drawn through the center of the square.</p>
equal	<p>The SignWriting for 'equal' shows two hands with fingers pointing up and right, positioned above a square. A horizontal line is drawn through the center of the square.</p>







American Sign Language (ASL) Dictionary

Unedited 08082023

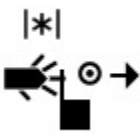
Spoken Word	SignWriting
equality	
equator	
er	
erase	
erase (board)	
erase (paper)	
eraser for board	
error	
escape	
escape	

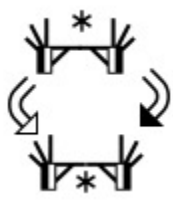

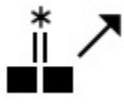





American Sign Language (ASL) Dictionary

Unedited 08082023

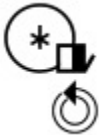
Spoken Word	SignWriting
Escape	
Esperanto	
essential	
establish	
esteem-deflated	
estranged	
etc	
etc	







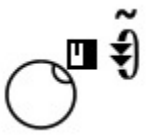

American Sign Language (ASL) Dictionary

Unedited 08082023

Spoken Word	SignWriting
etc	
etc	
etc	
Ethiopia	
europe	
Europe	
Europe	
Europe	
Europe	



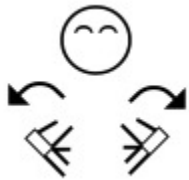



American Sign Language (ASL) Dictionary

Unedited 08082023

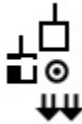
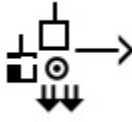
Spoken Word	SignWriting
European	
evaluate	
evaluate	
evaporate	
evening	
event	
events	
ever	

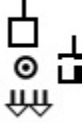

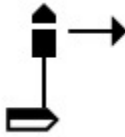

American Sign Language (ASL) Dictionary

Unedited 08082023

Spoken Word	SignWriting
every	
every	
every	
every - left hand primary	
every afternoon	
every afternoon	
every friday	
every hour	

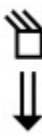
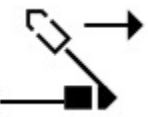
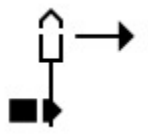
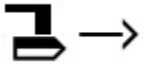

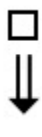
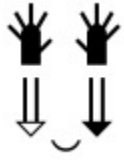



American Sign Language (ASL) Dictionary

Unedited 08082023

Spoken Word	SignWriting
every Monday	
every morning	
every morning	
every night	
every night	
Every Saturday	
every Saturday	
every sunday	
every Thursday	

American Sign Language (ASL) Dictionary

Unedited 08082023

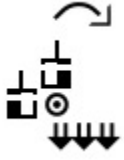
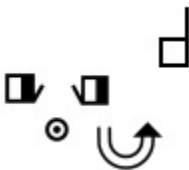
Spoken Word	SignWriting
every Tuesday	
every two weeks	
every Wednesday	
every-Saturday	
everyday	
everyday	
everyone	
everyone	

American Sign Language (ASL) Dictionary

Unedited 08082023

Spoken Word	SignWriting
everything	
everything	
everywhere (left)	
everywhere (right)	
evidence	
evidence	
evil	
evil	
evil	





American Sign Language (ASL) Dictionary

Unedited 08082023

Spoken Word	SignWriting
Evolution	 The SignWriting symbol for 'Evolution' consists of a vertical stack of elements: an upward-pointing arrow with a small vertical line above it, a lowercase letter 'e', an asterisk, and two hands in a specific orientation. A horizontal line is positioned below the hands.

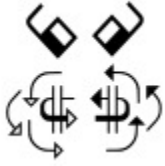
American Sign Language (ASL) Dictionary

Unedited 08082023

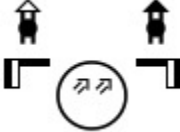
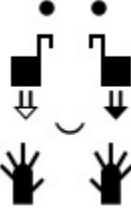
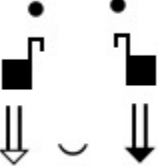
Spoken Word	SignWriting
Evolution	
exact	
exact	
exaggerate	
exalt	
exam	
exam	







American Sign Language (ASL) Dictionary

Unedited 08082023

Spoken Word	SignWriting
exam	
exam -2	
examination	
examine	
example	
example	
example	
exceed	
excel	

American Sign Language (ASL) Dictionary

Unedited 08082023

Spoken Word	SignWriting
excellency	
except	
except	
exceptional	
exchange	
exchange	
exchange	









American Sign Language (ASL) Dictionary

Unedited 08082023

Spoken Word	SignWriting
excite	<p>The SignWriting for 'excite' consists of a face with a wide smile and squinted eyes at the top. Below the face, there are two hands: the left hand is in a 'V' shape with fingers spread, and the right hand is in a '3' shape with fingers spread. Below these hands are two small circles, one on each side.</p>
excited	<p>The SignWriting for 'excited' features a face with a wide smile and squinted eyes at the top. Below the face, there are two hands: the left hand is in a 'V' shape with fingers spread, and the right hand is in a '3' shape with fingers spread. Below these hands are two small circles, one on each side.</p>
excited	<p>The SignWriting for 'excited' consists of a face with a wide smile and squinted eyes at the top. Below the face, there are two hands: the left hand is in a 'V' shape with fingers spread, and the right hand is in a '3' shape with fingers spread. Below these hands are two small circles, one on each side.</p>
excited	<p>The SignWriting for 'excited' consists of a face with a wide smile and squinted eyes at the top. Below the face, there are two hands: the left hand is in a 'V' shape with fingers spread, and the right hand is in a '3' shape with fingers spread. Below these hands are two small circles, one on each side.</p>
exclamation-point	<p>The SignWriting for 'exclamation-point' is a single horizontal line with a small arrowhead pointing to the right at its end.</p>
exclude	<p>The SignWriting for 'exclude' consists of a face with a wide smile and squinted eyes at the top. Below the face, there are two hands: the left hand is in a 'V' shape with fingers spread, and the right hand is in a '3' shape with fingers spread. Below these hands are two small circles, one on each side.</p>
excrement	<p>The SignWriting for 'excrement' consists of a face with a wide smile and squinted eyes at the top. Below the face, there are two hands: the left hand is in a 'V' shape with fingers spread, and the right hand is in a '3' shape with fingers spread. Below these hands are two small circles, one on each side.</p>

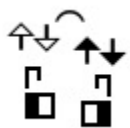

American Sign Language (ASL) Dictionary

Unedited 08082023

Spoken Word	SignWriting
excuse	
excuse	
excuse	
excuse-me	
execute	
Executive	
exempt	
exempt	
exercise	



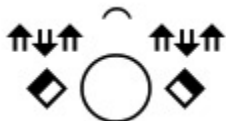
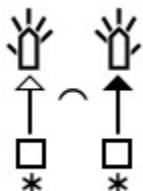
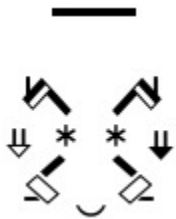
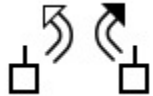
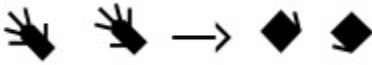
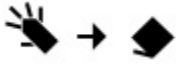
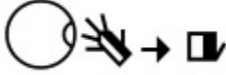



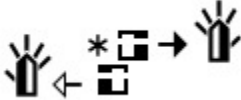

American Sign Language (ASL) Dictionary

Unedited 08082023

Spoken Word	SignWriting
exercise	
exhausted	
exhausted	
exist	
exit	
exit	
exit	
expand	
expand	



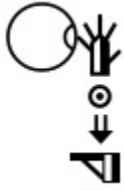

American Sign Language (ASL) Dictionary

Unedited 08082023

Spoken Word	SignWriting
expand	
expand	
expect to get answer	
expectations	
expedite	
expense	
expensive	
expensive	
experience	



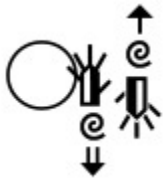
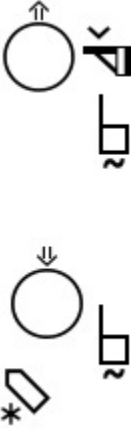
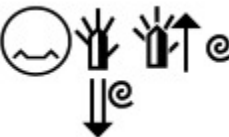

American Sign Language (ASL) Dictionary

Unedited 08082023

Spoken Word	SignWriting
experience	
experience	
experience thoroughly	
experience-rest	
experience-thoroughly	
experiences	
experiment	

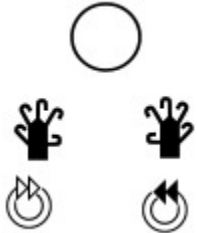

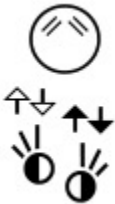

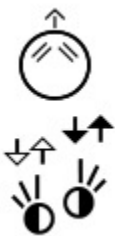
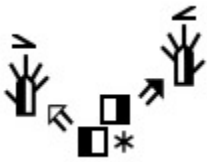

American Sign Language (ASL) Dictionary

Unedited 08082023

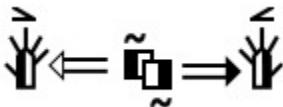
Spoken Word	SignWriting
experiment	
expert	
explain	
explain	
explain	
explain	
explode	

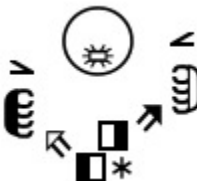



American Sign Language (ASL) Dictionary

Unedited 08082023

Spoken Word	SignWriting
explode	
explode	
explore	
explosion	
export data	
expose	
express (v) I express	

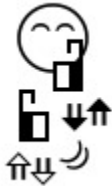
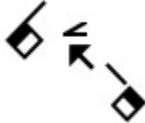
American Sign Language (ASL) Dictionary

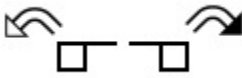
Unedited 08082023

Spoken Word	SignWriting
expression	
expression	
expressly	
extend	
extra	
extreme	
eye	
eye contact	





American Sign Language (ASL) Dictionary

Unedited 08082023

Spoken Word	SignWriting
eye contact broken	<p>The SignWriting symbol consists of three parts: a diamond shape with an arrow pointing left, a square with an arrow pointing up and right, and a circle with a downward-pointing arrow and two small upward-pointing arrows above it.</p>
Eye gaze right, eyebrows up	<p>The SignWriting symbol is a circle with two arrows pointing right from the eyes and two upward-pointing arrows above the eyebrows.</p>
eye popping	<p>The SignWriting symbol features a central circle with a smiling mouth. Above it are two sets of arrows: the left set has an upward arrow followed by a downward arrow, and the right set has a downward arrow followed by an upward arrow.</p>
eyebrow	<p>The SignWriting symbol shows a circle with a horizontal line above it representing an eyebrow, and a square with an arrow pointing up and right.</p>
eyebrows	<p>The SignWriting symbol depicts a circle with two horizontal lines above it representing eyebrows, and two squares with arrows pointing up and right on either side.</p>
eyebrows raised	<p>The SignWriting symbol is a circle with two upward-pointing arrows above it, and an L-shaped line below it.</p>
eyebrows raised	<p>The SignWriting symbol is a circle with two upward-pointing arrows above it, and an L-shaped line to its left.</p>
eyebrows raised	<p>The SignWriting symbol is a circle with two upward-pointing arrows above it.</p>
eyebrows up	<p>The SignWriting symbol shows a circle with two upward-pointing arrows above it, and two squares with arrows pointing up and right on either side.</p>











American Sign Language (ASL) Dictionary

Unedited 08082023

Spoken Word	SignWriting
eyebrows up	
eyebrows up	
eyebrows up	
eyebrows up mouth open	
eyegaze down	











American Sign Language (ASL) Dictionary

Unedited 08082023

Spoken Word	SignWriting
eyegaze left	
eyegaze right	
eyegaze right	
Eyegaze right	
eyelashes	
eyelashes	
eyelid	
eyes	
eyes big, eyebrows up	
eyes big, eyebrows up	
Eyes crossed, Eyebrows Down	









American Sign Language (ASL) Dictionary

Unedited 08082023

Spoken Word	SignWriting
Eyes gaze right, Eyebrows Up	
Eyes Half Closed	
eyes squint	
F	
F	
fabric	
fabric	
face	
face	
face God	







American Sign Language (ASL) Dictionary

Unedited 08082023

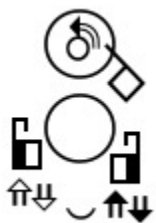
Spoken Word	SignWriting
face scared	
face to face	
face to face	
facial	
facial	
facial	
facial	
facial	

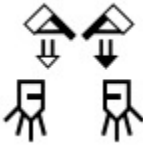





American Sign Language (ASL) Dictionary

Unedited 08082023

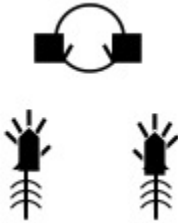
Spoken Word	SignWriting
facial expression	
facilitate	
fact	
factoring	
factory	
fade	
fahrenheit	
fail	



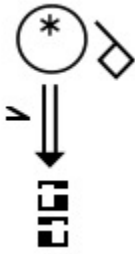

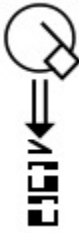

American Sign Language (ASL) Dictionary

Unedited 08082023

Spoken Word	SignWriting
faint	
fair	
fairy	
faith	
faith	
faith	
faith	

American Sign Language (ASL) Dictionary

Unedited 08082023

Spoken Word	SignWriting
faith-in-God	
faithful	
faithfulness	
fake	
fall	
fall	

American Sign Language (ASL) Dictionary

Unedited 08082023

Spoken Word	SignWriting
fall asleep	<p>The signwriting sequence for 'fall asleep' consists of: a downward arrow pointing to a circle with two horizontal lines for eyes; a downward arrow pointing to a hand with fingers spread; a downward arrow pointing to a diamond shape with an asterisk to its left; a downward arrow pointing to a diamond shape with an upward arrow below it; and finally a downward arrow pointing to a hand with fingers spread.</p>
fall down	<p>The signwriting sequence for 'fall down' consists of: a downward arrow pointing to a square with a smaller square inside it, followed by an asterisk; and a downward arrow pointing to a square with a rightward arrow below it, followed by a square with a rightward arrow below it, and finally a hash symbol (#).</p>
fall in love	<p>The signwriting sequence for 'fall in love' consists of: a downward arrow pointing to a circle with a vertical line extending downwards to a square; a downward arrow pointing to a square with an asterisk to its left; a downward arrow pointing to a square with a rightward arrow below it; and finally a downward arrow pointing to a square with an asterisk to its left and a square with an asterisk to its right.</p>
fall in love	<p>The signwriting sequence for 'fall in love' consists of: a downward arrow pointing to a square with a rightward arrow below it, followed by an asterisk; a downward arrow pointing to a square with a rightward arrow below it, followed by an asterisk; and finally a downward arrow pointing to a square with an upward arrow below it.</p>
fall-down	<p>The signwriting sequence for 'fall-down' consists of: a downward arrow pointing to a square with a rightward arrow below it, followed by a square with a rightward arrow below it; a downward arrow pointing to a hand with fingers spread; a downward arrow pointing to a square with a rightward arrow below it, followed by a square with a rightward arrow below it, and finally a hash symbol (#).</p>
fall-flat	<p>The signwriting sequence for 'fall-flat' consists of: a downward arrow pointing to a hand with fingers spread; a downward arrow pointing to a square with a rightward arrow below it, followed by a square with a rightward arrow below it, and finally a hash symbol (#); and a downward arrow pointing to a square with a rightward arrow below it, followed by a square with a rightward arrow below it, and finally a downward arrow pointing to a square with a rightward arrow below it.</p>





American Sign Language (ASL) Dictionary

Unedited 08082023

Spoken Word	SignWriting
fall-in-love	<p>The SignWriting symbol for 'fall-in-love' consists of a circle with a vertical line through its center and a horizontal line at the top. Below the circle is a square, followed by a double-lined downward arrow. Below that is another square, then a horizontal line with an asterisk to its right, and finally a diamond shape.</p>
falling	<p>The SignWriting symbol for 'falling' consists of a hand with fingers spread, followed by a zigzag line representing a path or fall.</p>
false	<p>The SignWriting symbol for 'false' consists of a circle with a vertical line through its center and a horizontal line at the top. Below the circle is a square, followed by a circle with a dot in the center, and finally a diamond shape.</p>
false	<p>The SignWriting symbol for 'false' consists of a circle with a vertical line through its center and a horizontal line at the top. Below the circle is a square, followed by a circle with an asterisk inside, and finally a diamond shape.</p>
false	<p>The SignWriting symbol for 'false' consists of a circle with a vertical line through its center and a horizontal line at the top. Below the circle is a square, followed by a circle with a dot in the center, and finally a diamond shape.</p>
false	<p>The SignWriting symbol for 'false' consists of a circle with a vertical line through its center and a horizontal line at the top. Below the circle is a square, followed by a circle with a dot in the center, and finally a diamond shape.</p>
false	<p>The SignWriting symbol for 'false' consists of a circle with a vertical line through its center and a horizontal line at the top. Below the circle is a square, followed by a circle with an asterisk inside, and finally a diamond shape.</p>

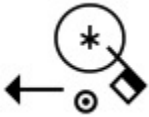

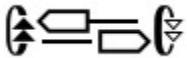
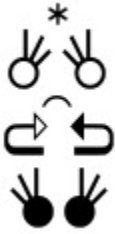
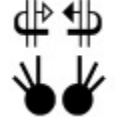
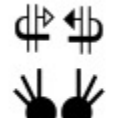
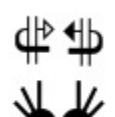



American Sign Language (ASL) Dictionary

Unedited 08082023

Spoken Word	SignWriting
false	
false	
false-start	
family	
family	
family	
family	
famous	

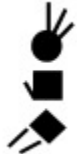





American Sign Language (ASL) Dictionary

Unedited 08082023

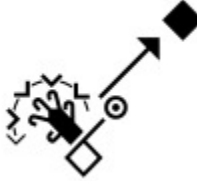
Spoken Word	SignWriting
fancy	
fancy	
fancy - left hand	
FAQ	
far	
far	
far	
far	







American Sign Language (ASL) Dictionary

Unedited 08082023

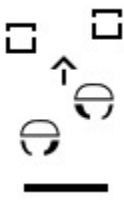
Spoken Word	SignWriting
far-out	
farm	
farm	
farmer	
farout	
farout	
fart	



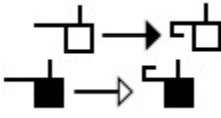

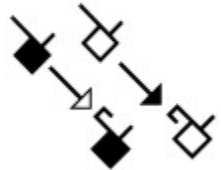

American Sign Language (ASL) Dictionary

Unedited 08082023

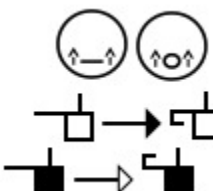
Spoken Word	SignWriting
fascinate	
fascinate	
fascinating	
fascination	
fast	
fast	
fast	









American Sign Language (ASL) Dictionary

Unedited 08082023

Spoken Word	SignWriting
fast	
fasten	
fat	
fat	
father	
father	
father	



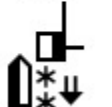

American Sign Language (ASL) Dictionary

Unedited 08082023

Spoken Word	SignWriting
father	
father	
father	
father	
father	
father	
father-in-law	
father-left-hand	
fatso	

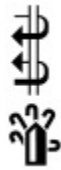

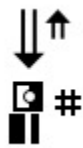
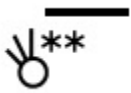

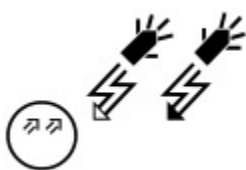



American Sign Language (ASL) Dictionary

Unedited 08082023

Spoken Word	SignWriting
faucet	
faucet	
fault	
fault	
Fauntaye	
favorite	
favorite	
fear-holy	



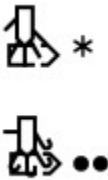

American Sign Language (ASL) Dictionary

Unedited 08082023

Spoken Word	SignWriting
February	
February	
February	
feces	
fed up	
fed-up	
federal	
feeble	
feeble	



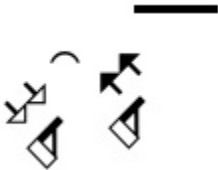
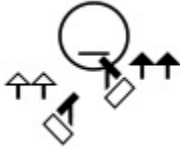

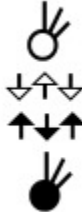



American Sign Language (ASL) Dictionary

Unedited 08082023

Spoken Word	SignWriting
feeble-minded	
feed	
feed	
feed	
feedback	
feedback	
feedback	

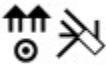





American Sign Language (ASL) Dictionary

Unedited 08082023

Spoken Word	SignWriting
feel	
feel	
feel	
feel-sore	
feeling	
feeling	
feeling	
feeling the room	
feelings	

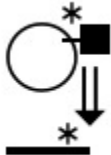

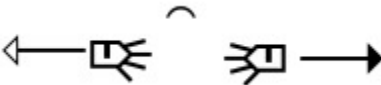
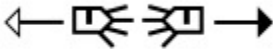





American Sign Language (ASL) Dictionary

Unedited 08082023

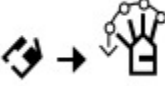
Spoken Word	SignWriting
feels-people-touching	
feet	
fellow	
feminist	
fence	
fence	
FERRIS-WHEEL	









American Sign Language (ASL) Dictionary

Unedited 08082023

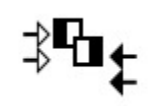
Spoken Word	SignWriting
ferris-wheel	
fever	
fever	
few	
few	
field	
field trip	
fifteen years old	
fifteen years old	
fifth	





American Sign Language (ASL) Dictionary

Unedited 08082023

Spoken Word	SignWriting
fifth-in-a-list	
fifteen years old	
fight	
fighting	
figure	
file	
file	
film	
film	

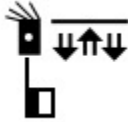



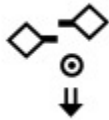
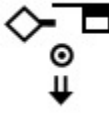

American Sign Language (ASL) Dictionary

Unedited 08082023

Spoken Word	SignWriting
film	
filter	
filthy	
filthy	
filthy	
final	
final	



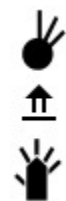
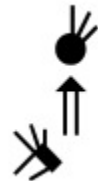



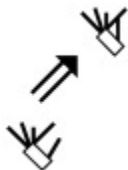

American Sign Language (ASL) Dictionary

Unedited 08082023

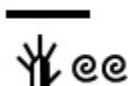
Spoken Word	SignWriting
finally	
finance	
find	
find	
find	
find	
find	

American Sign Language (ASL) Dictionary

Unedited 08082023

Spoken Word	SignWriting
find-me	
fine	
fine	
fine	
fine	
fine	
fine	
fine	
fine	

American Sign Language (ASL) Dictionary

Unedited 08082023

Spoken Word	SignWriting
fine - ticket	<p>The signwriting consists of a circle with a downward-pointing arrow, followed by a square with a circle inside, and a downward-pointing arrow.</p>
fine-leftt-hand	<p>The signwriting consists of an asterisk followed by a hand symbol with fingers spread.</p>
finger brushes tongue	<p>The signwriting consists of a circle with a dot inside, followed by a square with a circle inside and a downward-pointing arrow.</p>
finger brushes tongue	<p>The signwriting consists of a square with a downward-pointing arrow, a circle with a dot inside, and a square with a circle inside and a downward-pointing arrow.</p>
finger injury	<p>The signwriting consists of a diamond with a circle inside, a diamond with a cross inside, and a diamond with a circle inside.</p>
fingernail	<p>The signwriting consists of a diamond with a circle inside, a diamond with a cross inside, and a diamond with a circle inside.</p>
fingernail-polish	<p>The signwriting consists of a circle with a horizontal line inside, a diamond with a circle inside, and a diamond with a circle inside and a downward-pointing arrow.</p>





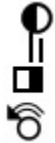

American Sign Language (ASL) Dictionary

Unedited 08082023

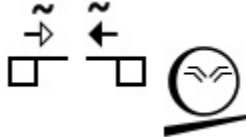
Spoken Word	SignWriting
fingers	
fingers check vagina	

American Sign Language (ASL) Dictionary

Unedited 08082023

Spoken Word	SignWriting
fingers in ears of another person	
fingerspell	
Fingerspeller	
Fingerspeller	
Fingerspeller is cool!	
fingerspelling	
fingerspelling	





American Sign Language (ASL) Dictionary

Unedited 08082023

Spoken Word	SignWriting
finish	
finish	
finish	
finish	
finish	
finish	

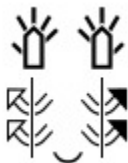
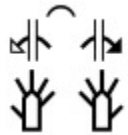
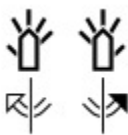
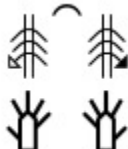
American Sign Language (ASL) Dictionary

Unedited 08082023

Spoken Word	SignWriting
finish	
finish	
finish	
finish	
finish	
finish	
finish	







American Sign Language (ASL) Dictionary

Unedited 08082023

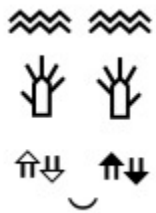
Spoken Word	SignWriting
finish-test	
finished	
Finland	
Finland	
Finland	
fire	
fire	

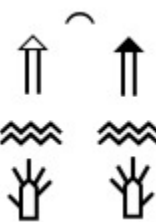
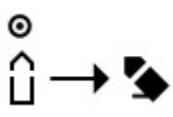

American Sign Language (ASL) Dictionary

Unedited 08082023

Spoken Word	SignWriting
fire	
fire	
fire	
fire	
fire-from-job	
firefighter	
firefighter	
firefighter	





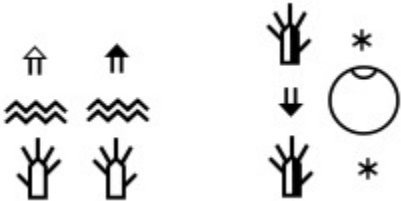
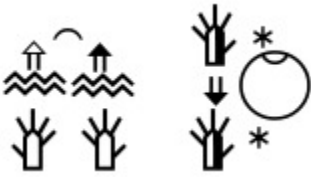
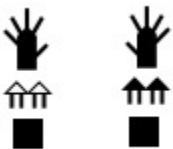
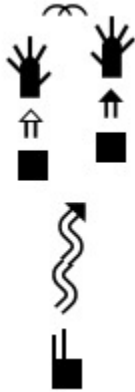



American Sign Language (ASL) Dictionary

Unedited 08082023

Spoken Word	SignWriting
fireman	
fireman	
fireman	
fireman	
fireworks	
fireworks	





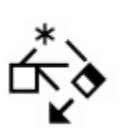

American Sign Language (ASL) Dictionary

Unedited 08082023

Spoken Word	SignWriting
firing-cannon-right	
first - left hand	
first of five	
first of three	
first of three	
first of two	
first on the list of three	
first with emphasis	
first-of-three	

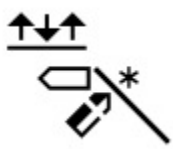
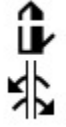





American Sign Language (ASL) Dictionary

Unedited 08082023

Spoken Word	SignWriting
first-second-third	
fish	
fish	
fish	
fish	
fish	
fishing	
fishing	

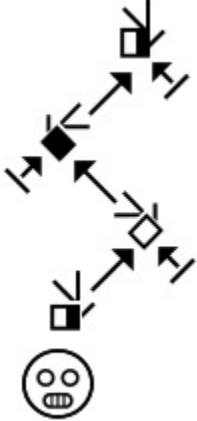



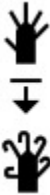

American Sign Language (ASL) Dictionary

Unedited 08082023

Spoken Word	SignWriting
fishing	
fishing reel	
fishtail	
five cents	
five dollars	
five hours	
five hundred	

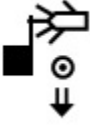

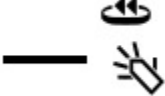



American Sign Language (ASL) Dictionary

Unedited 08082023

Spoken Word	SignWriting
five minutes	
five minutes	
five months	
five o'clock	
five of us	
five of us	
five of us	
five of you	





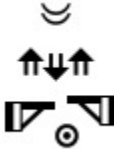
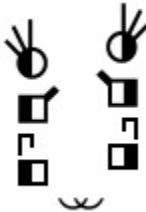

American Sign Language (ASL) Dictionary

Unedited 08082023

Spoken Word	SignWriting
five years old	
five years old	
five-left-hand	
five-of-us	
five-of-us	
five-of-us (left hand)	
five-of-us (right hand)	
fix	
fix	



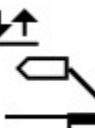

American Sign Language (ASL) Dictionary

Unedited 08082023

Spoken Word	SignWriting
fix	
fix	
flabbergasted	
flag	
flag	
flag	
flag	

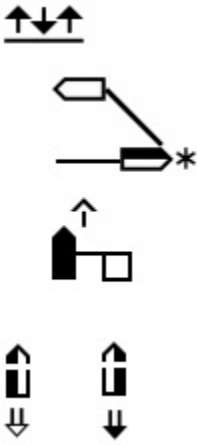

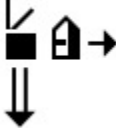
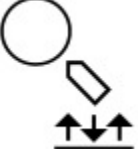

American Sign Language (ASL) Dictionary

Unedited 08082023

Spoken Word	SignWriting
flag waver	
flag-wave	
Flanders	
flapper	
Flash the Light	
flash the lights	

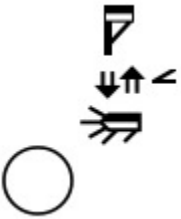







American Sign Language (ASL) Dictionary

Unedited 08082023

Spoken Word	SignWriting
flash-the-light	
flash-the-light	
flash-the-light	
flash-the-light	
flash-the-light	



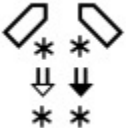



American Sign Language (ASL) Dictionary

Unedited 08082023

Spoken Word	SignWriting
flash-the-light	
flash-the-light	
flash-the-light	
flashing lights	
Flashlight	
flat object classifier	
flatter	
flesh	
flick	

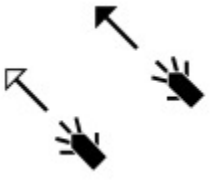
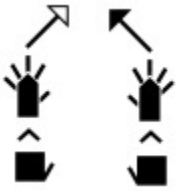

American Sign Language (ASL) Dictionary

Unedited 08082023

Spoken Word	SignWriting
flip	
flip	
flip flops	
flirt	
flirt	
float	
flock	
flock to	

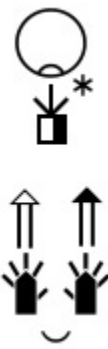
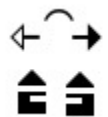

American Sign Language (ASL) Dictionary

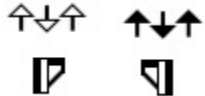
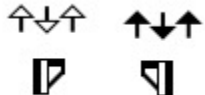
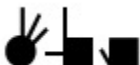
Unedited 08082023

Spoken Word	SignWriting
flood	
flood	
floor	
floor	
floor	
floppy	
floppy	
Florida	



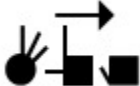
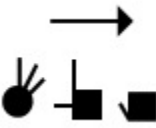
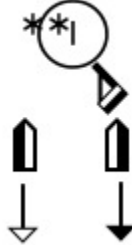
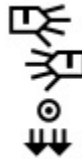
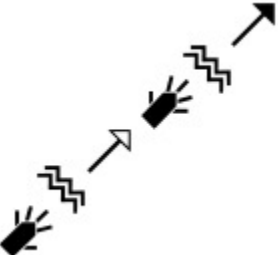

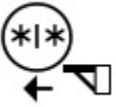

American Sign Language (ASL) Dictionary

Unedited 08082023

Spoken Word	SignWriting
Florida	
Florida	
florist	
flow	
flow-right	
flower	
flower	

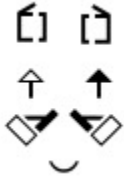
American Sign Language (ASL) Dictionary

Unedited 08082023

Spoken Word	SignWriting
flower	
flower	
fluent	
fluff-pillow	
Fluid	
flunk	
flutter	

American Sign Language (ASL) Dictionary

Unedited 08082023

Spoken Word	SignWriting
fly	
fly	
fly	
fly	
fly	
fly forward	
fly right	







American Sign Language (ASL) Dictionary

Unedited 08082023

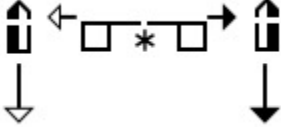
Spoken Word	SignWriting
fly-flick	
fly-on-and-on	
fly-on-and-on	
focus	
focus	
focus	





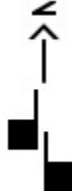

American Sign Language (ASL) Dictionary

Unedited 08082023

Spoken Word	SignWriting
focus on God	
foe	
Fog	
Fog	
fold	
folder	
folk	
follow	

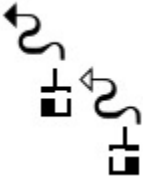

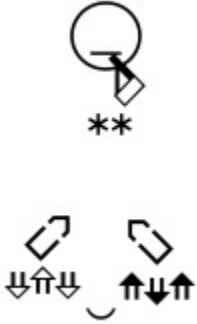



American Sign Language (ASL) Dictionary

Unedited 08082023

Spoken Word	SignWriting
follow	
follow	
follow winding road	
food	
food	
food service	
food-store	

American Sign Language (ASL) Dictionary

Unedited 08082023

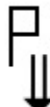
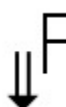
Spoken Word	SignWriting
fool	 <p>The SignWriting symbol for 'fool' consists of a hash symbol (#) above a square, with a small circle to the right. Below the square is an upward-pointing arrow, and to the right of the arrow is a rightward-pointing arrow.</p>
fool	 <p>The SignWriting symbol for 'fool' consists of a hash symbol (#) above a square, with a small circle to the right. Below the square is a downward-pointing arrow.</p>
foolish	 <p>The SignWriting symbol for 'foolish' features a central circle with two curved arrows forming a loop around it. To the left and right of the circle are hand icons with fingers extended.</p>
foolish	 <p>The SignWriting symbol for 'foolish' features a central circle with two curved arrows forming a loop around it. To the left and right of the circle are hand icons with fingers extended, pointing towards the center.</p>
foolish	 <p>The SignWriting symbol for 'foolish' features a central circle with two curved arrows forming a loop around it. To the left and right of the circle are hand icons with fingers extended, pointing towards the center.</p>
foolish	 <p>The SignWriting symbol for 'foolish' features a central circle with a vertical line through its center. To the right of the circle is a hand icon with fingers extended, pointing towards the circle.</p>
foot	 <p>The SignWriting symbol for 'foot' consists of a square above a downward-pointing arrow.</p>
foot	 <p>The SignWriting symbol for 'foot' consists of a downward-pointing arrow above a square.</p>









American Sign Language (ASL) Dictionary

Unedited 08082023

Spoken Word	SignWriting
foot care	<p>The SignWriting for 'foot care' consists of three vertically stacked symbols. The top symbol shows two black circles representing eyes with three lines radiating from each, and two asterisks below. The middle symbol shows a stylized foot with a black circle on the sole and a black circle on the heel. The bottom symbol is a flame-like shape.</p>
foot injury	<p>The SignWriting for 'foot injury' consists of three vertically stacked symbols. The top symbol is identical to the one for 'foot care'. The middle symbol shows a stylized foot with a black circle on the sole and a black circle on the heel. The bottom symbol shows a stylized foot with a black circle on the sole and a black circle on the heel, with a black square to its right.</p>
football	<p>The SignWriting for 'football' consists of two vertically stacked symbols. The top symbol shows two stylized hands with fingers pointing towards each other, with two vertical arrows above each hand. The bottom symbol is a vertical line with an asterisk in the center.</p>
football	<p>The SignWriting for 'football' consists of two vertically stacked symbols. The top symbol shows two stylized hands with fingers pointing towards each other, with two vertical arrows above each hand and a curved line above the right hand. The bottom symbol is a vertical line with two asterisks in the center.</p>
football	<p>The SignWriting for 'football' consists of two vertically stacked symbols. The top symbol is a vertical line with two asterisks in the center. The bottom symbol shows two stylized hands with fingers pointing towards each other.</p>
football helmet	<p>The SignWriting for 'football helmet' consists of two vertically stacked symbols. The top symbol shows two stylized hands with fingers pointing towards each other, with two vertical arrows above each hand and a curved line above the right hand. The bottom symbol is a vertical line with two asterisks in the center. Below this is a separate symbol consisting of two stylized hands with fingers pointing towards each other, with a circle between them and a downward arrow below each hand.</p>



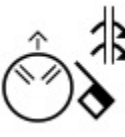



American Sign Language (ASL) Dictionary

Unedited 08082023

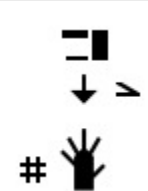
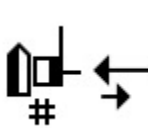
Spoken Word	SignWriting
for	
for	
for	
for	
for	
for-example	
for-for	
for-for	

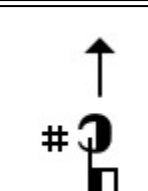
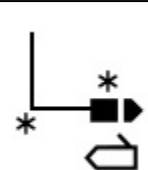

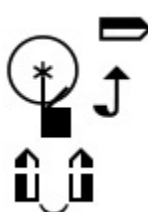
American Sign Language (ASL) Dictionary

Unedited 08082023

Spoken Word	SignWriting
forbid	
forbid-2	
force	
force	
forearm	
forecast	
forecaster	
forehead	



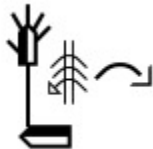





American Sign Language (ASL) Dictionary

Unedited 08082023

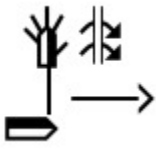
Spoken Word	SignWriting
foresee	
forest	
forest	

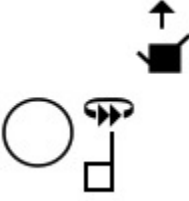





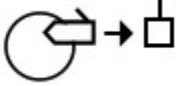
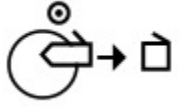

American Sign Language (ASL) Dictionary

Unedited 08082023

Spoken Word	SignWriting
forest	
forest	
forest	
forest	
forever	
forever	
Forget	
forget	

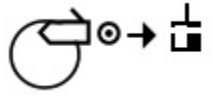







American Sign Language (ASL) Dictionary

Unedited 08082023

Spoken Word	SignWriting
forget	
forget	
forgive	
forgive	
forgive	
forgot	
fork	
fork	
fork	
form	



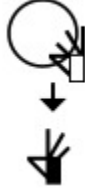
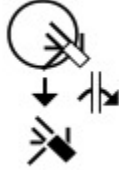

American Sign Language (ASL) Dictionary

Unedited 08082023

Spoken Word	SignWriting
formal	
Formal	
formal	
formal two handed	
formula	
formula	
fortunate	
fortunate	
forward movement	

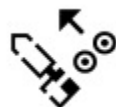
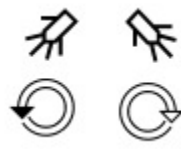

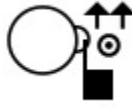
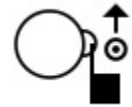

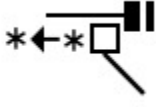
American Sign Language (ASL) Dictionary

Unedited 08082023

Spoken Word	SignWriting
fossil	
foster	
foster	
foul	
foul	
found	
found-from-above	
foundation	

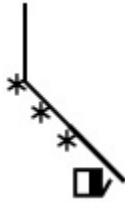
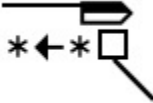
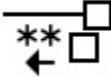
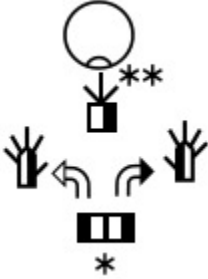





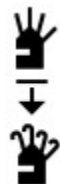

American Sign Language (ASL) Dictionary

Unedited 08082023

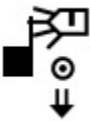
Spoken Word	SignWriting
foundation	
foundation	
foundation	
fountain	
four days	
four dollars	
four hours	



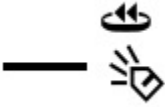





American Sign Language (ASL) Dictionary

Unedited 08082023

Spoken Word	SignWriting
four hundred	
four minutes	
four months	
four o'clock	
four of us	
four of us	
four of us	
four of us	







American Sign Language (ASL) Dictionary

Unedited 08082023

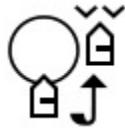
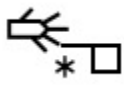
Spoken Word	SignWriting
four of us (left hand)	
four of us (right hand)	
four of us (right hand)	
four of you	
four years old	
four years old	
four-of-us	
four-to-six	
fourteen years old	



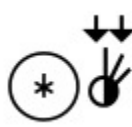





American Sign Language (ASL) Dictionary

Unedited 08082023

Spoken Word	SignWriting
fourteen years old	
fourth of five	
fourth-in-a-list	
fourty four	
fourty years old	
fox	
fox	
fraction	

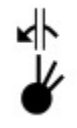







American Sign Language (ASL) Dictionary

Unedited 08082023

Spoken Word	SignWriting
fragrance	
fragrance	
fragrance	
France	
France	
frank	
Frank	
frankly	
fraternity	





American Sign Language (ASL) Dictionary

Unedited 08082023

Spoken Word	SignWriting
fraud	
freak	
freckle	
freckles	
free	
free	
free	
free	

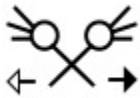
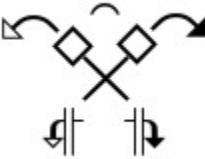

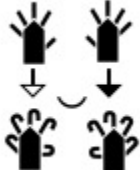

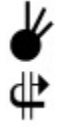

American Sign Language (ASL) Dictionary

Unedited 08082023

Spoken Word	SignWriting
free	
Free	
free (fists)	
freeway	
freeze	
french	
french	
French (LSF)	



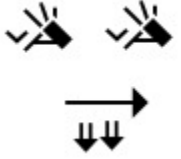





American Sign Language (ASL) Dictionary

Unedited 08082023

Spoken Word	SignWriting
french fries	
french fries	
french fries	
french fries	
french fry	
french-fries	
french-fries	
frequent	

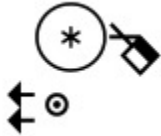





American Sign Language (ASL) Dictionary

Unedited 08082023

Spoken Word	SignWriting
frequently	
frequently	
freshman	
freshman	
freshman	
freshman	
friction	
Friday	
Friday	

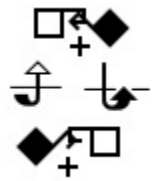

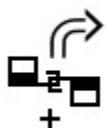



American Sign Language (ASL) Dictionary

Unedited 08082023

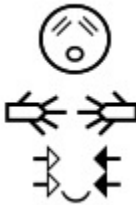
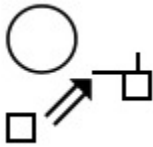
Spoken Word	SignWriting
Fridays	
friend	
friend	
friend	
friend	
friendly	
friends	
friends	







American Sign Language (ASL) Dictionary

Unedited 08082023

Spoken Word	SignWriting
friends	
frightened	
frisbee	
frog	
frog	
frog	
frog	
from	





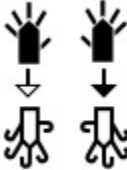
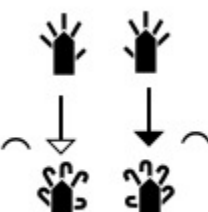

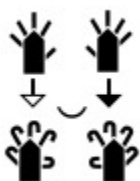

American Sign Language (ASL) Dictionary

Unedited 08082023

Spoken Word	SignWriting
from	
from	
from	
from	
from-now-on	
front	
front car damage	
frost	







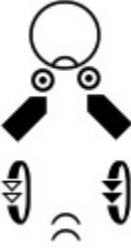

American Sign Language (ASL) Dictionary

Unedited 08082023

Spoken Word	SignWriting
frown	
frozen	
fruit	
frustrate	
frustrate	
frustrate	
frustrate	
frustrate	
frustrated	





American Sign Language (ASL) Dictionary

Unedited 08082023

Spoken Word	SignWriting
frustrated	
frustrated	
frustrated	
fry	
FS	
fuel	
full	
full	

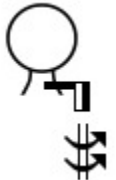
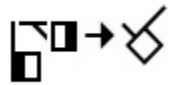

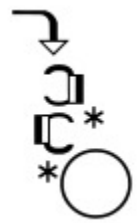



American Sign Language (ASL) Dictionary

Unedited 08082023

Spoken Word	SignWriting
full	
full	
full battery	
full beard	
full-of-knowledge	
fullness	
fully	

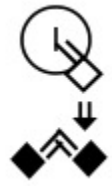



American Sign Language (ASL) Dictionary

Unedited 08082023

Spoken Word	SignWriting
fumble	
fun	
fun	
fun	
fund	
fundamental	
funding	

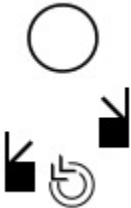
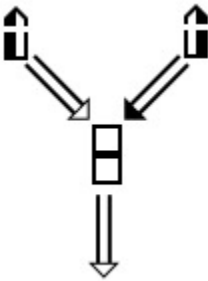



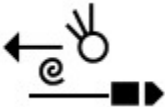
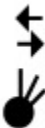



American Sign Language (ASL) Dictionary

Unedited 08082023

Spoken Word	SignWriting
funeral	
funnel	
funny	
funny	
funny	
fur	
furniture	

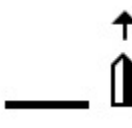

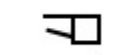

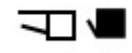
American Sign Language (ASL) Dictionary

Unedited 08082023

Spoken Word	SignWriting
further	
fuss	
fussy	
future	
future	
fuzzy	
G	
G	
GA	



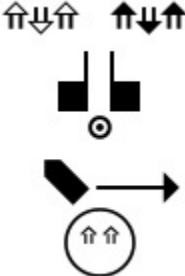
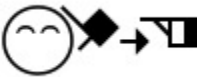

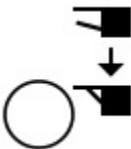

American Sign Language (ASL) Dictionary

Unedited 08082023

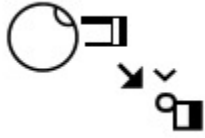
Spoken Word	SignWriting
Gala	
Galatians	
galaxy	
Gallaudet	
Gallaudet	
Gallaudet	

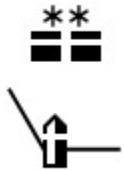

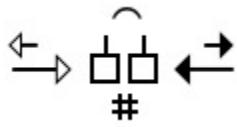
American Sign Language (ASL) Dictionary

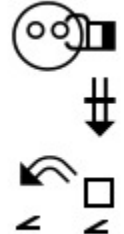
Unedited 08082023

Spoken Word	SignWriting
Gallaudet	
Gallaudet	
gallop	
galoshes	
game	
game	
game	
Gandhi	



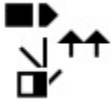
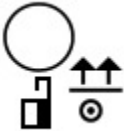
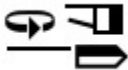





American Sign Language (ASL) Dictionary

Unedited 08082023

Spoken Word	SignWriting
gaping mouth	
garage	
garbage	
garden	
garden	
gas	

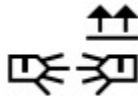



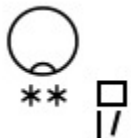

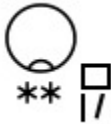

American Sign Language (ASL) Dictionary

Unedited 08082023

Spoken Word	SignWriting
gas	
gas	
gas	
gas	
gate	
gather	
gather	
gay	
gay	

American Sign Language (ASL) Dictionary

Unedited 08082023

Spoken Word	SignWriting
gay	
gay	
gay	
gee	
geek	
gender	
gene	
generally	







American Sign Language (ASL) Dictionary

Unedited 08082023

Spoken Word	SignWriting
generally	<p>The SignWriting for 'generally' consists of several components: two hand shapes at the top, a central symbol resembling a dollar sign with a tilde (~) above it, and two hand shapes at the bottom with an asterisk (*) between them.</p>
generations	<p>The SignWriting for 'generations' includes a horizontal line at the top, a hand shape on the left, a hand shape on the right, and a downward-pointing arrow at the bottom.</p>
generations	<p>The SignWriting for 'generations' includes a horizontal line at the top, a hand shape on the left, a hand shape on the right, and two upward-pointing arrows at the bottom.</p>
generations	<p>The SignWriting for 'generations' includes a horizontal line at the top, a hand shape on the left, a hand shape on the right, and a downward-pointing arrow at the bottom.</p>
generations	<p>The SignWriting for 'generations' includes a horizontal line at the top, a hand shape on the left, a hand shape on the right, and a downward-pointing arrow at the bottom.</p>
generations	<p>The SignWriting for 'generations' includes a horizontal line at the top, a hand shape on the left, a hand shape on the right, and a downward-pointing arrow at the bottom.</p>
Genesis	<p>The SignWriting for 'Genesis' consists of a hand shape on the left and a hand shape on the right with a downward-pointing arrow below it.</p>

American Sign Language (ASL) Dictionary

Unedited 08082023

Spoken Word	SignWriting
genius	
gentile	
gentle	
gentleman	
gentleman	
gentleman	
gentleman	





American Sign Language (ASL) Dictionary

Unedited 08082023

Spoken Word	SignWriting
gentleman - left	
gentleman - right	
gentleman-left	
geography	
geologist	
geology	
geometry	

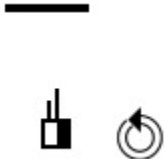

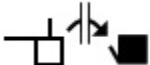
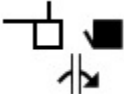
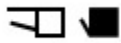





American Sign Language (ASL) Dictionary

Unedited 08082023

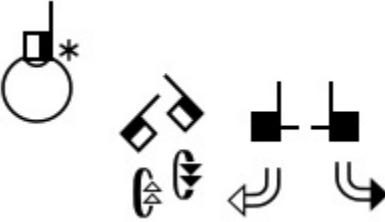
Spoken Word	SignWriting
George	
george	
George W. Bush	
Georgia	
Georgia	
Georgia	
geosphere	
German	







American Sign Language (ASL) Dictionary

Unedited 08082023

Spoken Word	SignWriting
German	
German	
German Sign Language	
Germany	
Germany	
Germany	
Germany	
Germany	



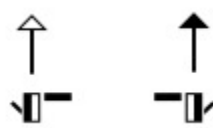
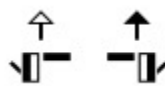

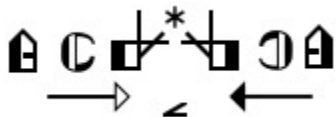

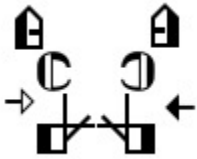

American Sign Language (ASL) Dictionary

Unedited 08082023

Spoken Word	SignWriting
gesture	
get	
get	
get	
get along	
get along	
get away	
get back together	





American Sign Language (ASL) Dictionary

Unedited 08082023

Spoken Word	SignWriting
get back together	
get gas	
get in bed	
get in bed	
get in vehicle	
get out of vehicle	
get together	
get up	
get-in	

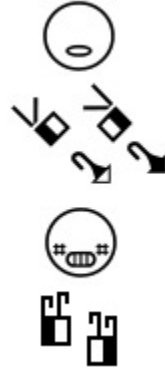



American Sign Language (ASL) Dictionary

Unedited 08082023

Spoken Word	SignWriting
get-out-of	
get-sick	
get-up	
getting closer	
ghost	
giant	

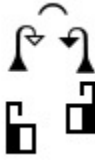

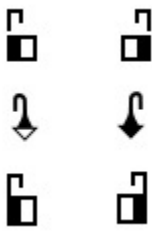



American Sign Language (ASL) Dictionary

Unedited 08082023

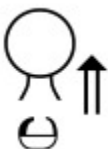
Spoken Word	SignWriting
gift	
gift	
gift - left hand	
gift - right hand	
gift money	
gills	
Ginger	





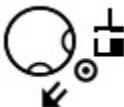



American Sign Language (ASL) Dictionary

Unedited 08082023

Spoken Word	SignWriting
Ginger	
girafa	
giraffe	
girl	
girl	
girl	
girl	
girl	







American Sign Language (ASL) Dictionary

Unedited 08082023

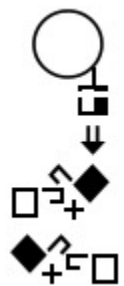
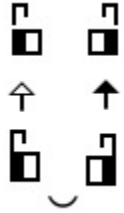
Spoken Word	SignWriting
girl	
girl	
girl	
girl	
girl	
girl	
girl (left hand)	
girl-left-hand	



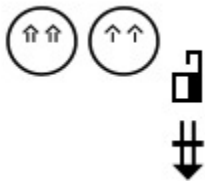



American Sign Language (ASL) Dictionary

Unedited 08082023

Spoken Word	SignWriting
girlfriend	
Give	
Give	
give	
give	
give	
give	

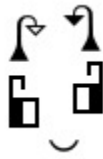

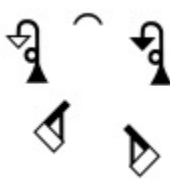





American Sign Language (ASL) Dictionary

Unedited 08082023

Spoken Word	SignWriting
give	
give	
give	
give	
give	
give	
give	
give	

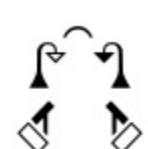



American Sign Language (ASL) Dictionary

Unedited 08082023

Spoken Word	SignWriting
give	
give	
give (2) you give me	
give (2) you give me	
give (v) I give you	
give (v) I give you	
give heart	
give myself baby	

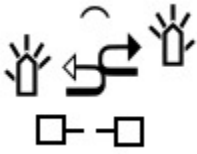



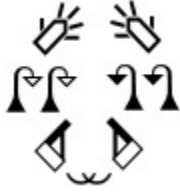
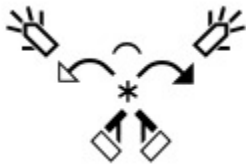

American Sign Language (ASL) Dictionary

Unedited 08082023

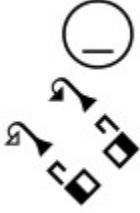
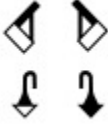
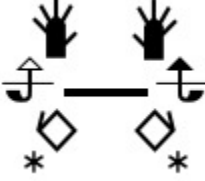
Spoken Word	SignWriting
give to me	
give-back	
give-cup-to	
give-cups-to-several-people	
give-gift	
give-give	
give-out	

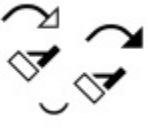

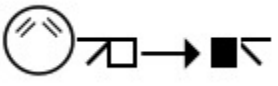

American Sign Language (ASL) Dictionary

Unedited 08082023

Spoken Word	SignWriting
give-to	
give-to-me	
give-up	
GIVE-you	
gives	
glad	
glance	
glass	

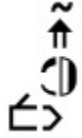

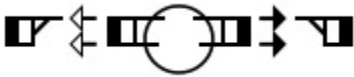
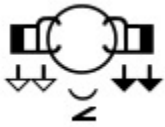



American Sign Language (ASL) Dictionary

Unedited 08082023

Spoken Word	SignWriting
glass	
glass	
glasses	
glasses	
glasses	
glasses	
Glasses	
glicemia	

American Sign Language (ASL) Dictionary

Unedited 08082023

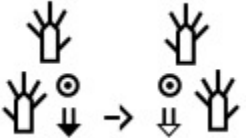
Spoken Word	SignWriting
glimpse	
global	
globe	
globe	
glory	
glory	
glove	
gloves	





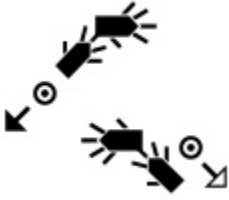
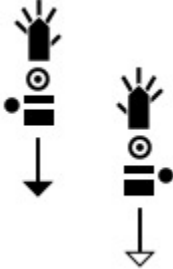
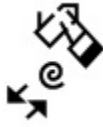
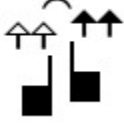
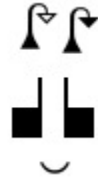
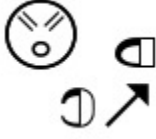
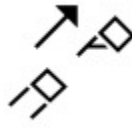

American Sign Language (ASL) Dictionary

Unedited 08082023

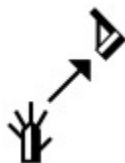
Spoken Word	SignWriting
gloves	
gloves	
glue	
go	
go	
go	
go	

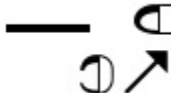
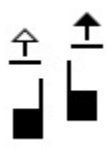

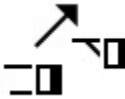

American Sign Language (ASL) Dictionary

Unedited 08082023

Spoken Word	SignWriting
go	
go	
go	
go	
go	
go	
go	
go	

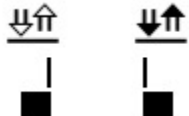
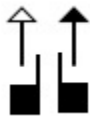

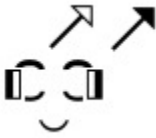
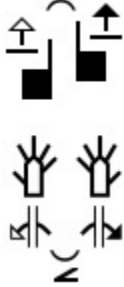

American Sign Language (ASL) Dictionary

Unedited 08082023

Spoken Word	SignWriting
go	
go	
go	
go	
go	
Go	
go (plural)	
go (v) went	

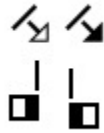
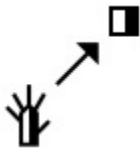
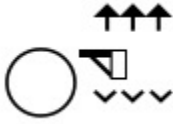

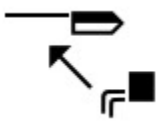
American Sign Language (ASL) Dictionary

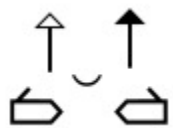
Unedited 08082023

Spoken Word	SignWriting
go backwards right	
go out	
go out repeatedly	
go straight	
go through doorway	
go under table	
go up years	
go-ahead	



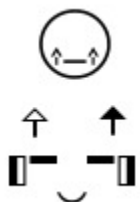
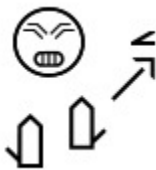
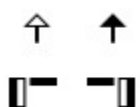

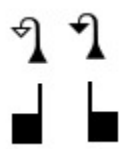
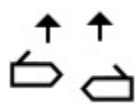
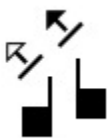
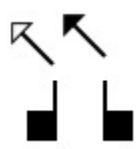
American Sign Language (ASL) Dictionary

Unedited 08082023

Spoken Word	SignWriting
go-ahead	
go-ahead	
go-ahead	
go-away-	
go-down	
go-forward	
go-l	
go-left	

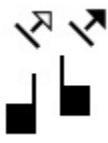

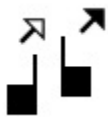

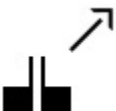



American Sign Language (ASL) Dictionary

Unedited 08082023

Spoken Word	SignWriting
go-plural-forward	
go-r	
go-r one handed	
go-right	
go-right	
go-together-left	
go-together-right	







American Sign Language (ASL) Dictionary

Unedited 08082023

Spoken Word	SignWriting
go-up-years	
goal	
goal	
Goal	
goal left	
goat	
goat	
goatee	



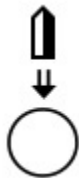

American Sign Language (ASL) Dictionary

Unedited 08082023

Spoken Word	SignWriting
God	
God	
God	
God	
God	
God	
God himself	

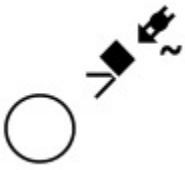
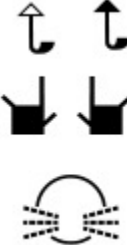



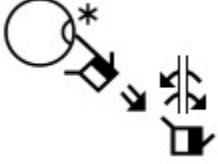

American Sign Language (ASL) Dictionary

Unedited 08082023

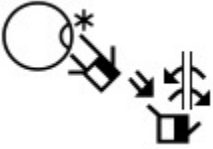
Spoken Word	SignWriting
God-look-down	
God-loves-you-much	
Goddess	
godly	
gold	
gold	





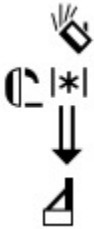

American Sign Language (ASL) Dictionary

Unedited 08082023

Spoken Word	SignWriting
gold	
Goldilocks	
Goldilocks	
Goldilocks	
golf	
golf	
gone	

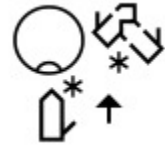

American Sign Language (ASL) Dictionary

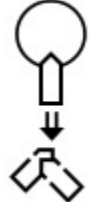
Unedited 08082023

Spoken Word	SignWriting
gone	
gone	
gone	
gone	
good	
good	
good	
good	



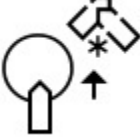
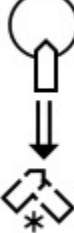
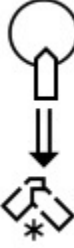
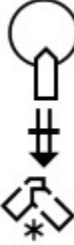

American Sign Language (ASL) Dictionary

Unedited 08082023

Spoken Word	SignWriting
good	
good	
good	
good	
good	
good	
good	

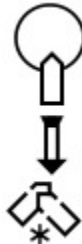
American Sign Language (ASL) Dictionary

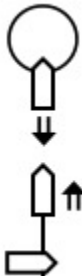
Unedited 08082023

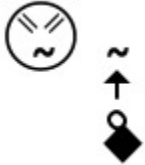
Spoken Word	SignWriting
good	
good income	
good morning	
good night	
good point	





American Sign Language (ASL) Dictionary

Unedited 08082023

Spoken Word	SignWriting
good-friend	
goodbye	
goodbye	
Google	
goose	
goosebumps	
gorilla	
gorilla	
Gospel	

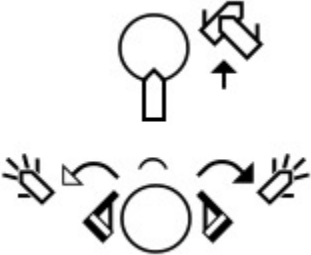
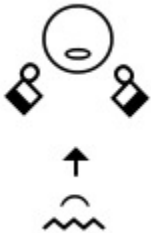
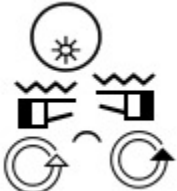





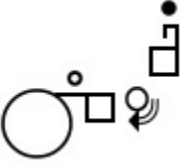

American Sign Language (ASL) Dictionary

Unedited 08082023

Spoken Word	SignWriting
Gospel	
gossip	
gossiping	
government	
government	
government	
government	



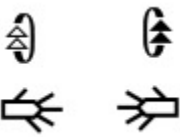

American Sign Language (ASL) Dictionary

Unedited 08082023

Spoken Word	SignWriting
government	
government	
government	
government	
government	
Government2	
Government3	
gown	
grab	

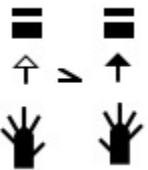
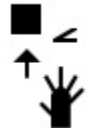

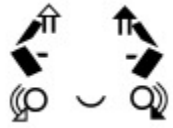
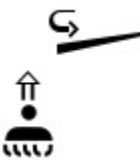
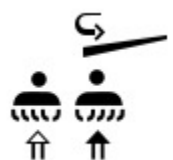



American Sign Language (ASL) Dictionary

Unedited 08082023

Spoken Word	SignWriting
grab	
grab	
grab	
grab and lift rounded object	
grab bar shaped object on left	
grab bar shaped object to left	
grab from left	
grab me	

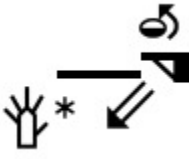
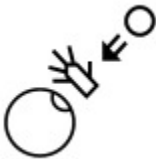
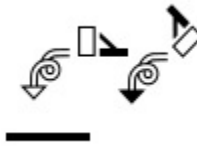





American Sign Language (ASL) Dictionary

Unedited 08082023

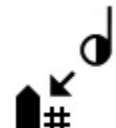
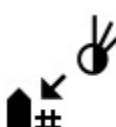
Spoken Word	SignWriting
grab me	
grab me	
grace	
grace	
gracious	
grade	
grade A	
grade B	

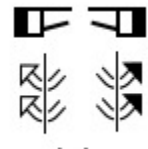

American Sign Language (ASL) Dictionary

Unedited 08082023

Spoken Word	SignWriting
grade C	
grade D	
grade F	
graduate	
graduate	
graduate school	
graduation	
grammar	
grammar	



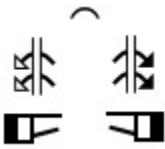



American Sign Language (ASL) Dictionary

Unedited 08082023

Spoken Word	SignWriting
grammar	
grammar	









American Sign Language (ASL) Dictionary

Unedited 08082023

Spoken Word	SignWriting
grandfather	
grandfather	
grandfather	
grandfather	
grandfather	
grandmother	
grandmother	

American Sign Language (ASL) Dictionary

Unedited 08082023

Spoken Word	SignWriting
grandmother	
grandparents	
grapes	
grapes	
grapes	
grapes	
grass	
grass	





American Sign Language (ASL) Dictionary

Unedited 08082023

Spoken Word	SignWriting
grass	<p>The SignWriting symbol for 'grass' consists of a circle at the top, a hand with fingers spread below it, and two upward-pointing arrows at the bottom. To the right of the hand are two asterisks (**).</p>
grasshopper	<p>The SignWriting symbol for 'grasshopper' features a diamond shape with a horizontal line above it, a curved arrow pointing right, and a horizontal line with an arrowhead pointing right below it. Three asterisks (***) are positioned below the symbol.</p>
grassland	<p>The SignWriting symbol for 'grassland' includes a circle at the top, a hand with fingers spread below it, and two upward-pointing arrows at the bottom. To the right of the hand are two small circles and a hand with a curved arrow pointing right.</p>
grassroots	<p>The SignWriting symbol for 'grassroots' shows a circle at the top, a horizontal line below it, and a hand with fingers spread below the line.</p>
grate	<p>The SignWriting symbol for 'grate' depicts a hand with fingers spread, a circular arrow, and two upward-pointing arrows.</p>
gratitude	<p>The SignWriting symbol for 'gratitude' features a smiling face with two upward-pointing arrows on either side.</p>
gratitude	<p>The SignWriting symbol for 'gratitude' shows a hand with fingers spread, a circular arrow, and two upward-pointing arrows. Below this is a circle containing two upward-pointing arrows, with a hand pointing to it from the bottom.</p>



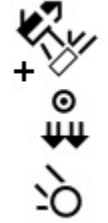
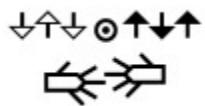

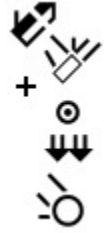
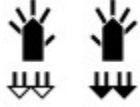

American Sign Language (ASL) Dictionary

Unedited 08082023

Spoken Word	SignWriting
grave	
grave	
gravy	
gray	
gray	
grease	
grease	
Great Britain	







American Sign Language (ASL) Dictionary

Unedited 08082023

Spoken Word	SignWriting
great grandfather	
great grandfather	
great grandmother	
great great grandfather	
great great grandfather	
great great grandmother	
grecian	



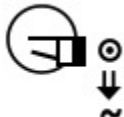
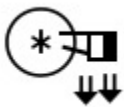

American Sign Language (ASL) Dictionary

Unedited 08082023

Spoken Word	SignWriting
Greece	
Greece	
Greece	
greed	
Greek	
Greek	
Greek	
green	





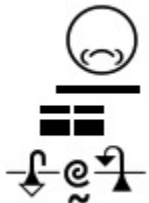
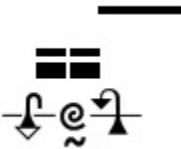
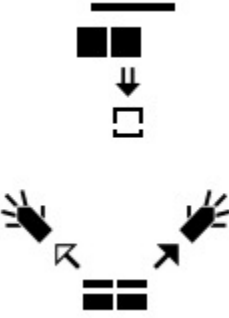

American Sign Language (ASL) Dictionary

Unedited 08082023

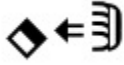
Spoken Word	SignWriting
green	
green	
grey	
grey	
grief	
grief	
grief	

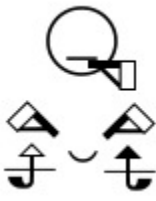
American Sign Language (ASL) Dictionary

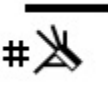
Unedited 08082023

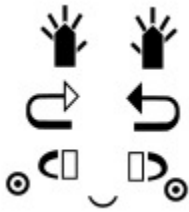
Spoken Word	SignWriting
grim	
grip	
gripe	
grocery	
gross	
gross	
grouchy	
ground	



American Sign Language (ASL) Dictionary

Unedited 08082023

Spoken Word	SignWriting
ground	<p>The signwriting for 'ground' consists of two rows of symbols. The top row has two 'ee' symbols, each with a small square below it. The bottom row has a left-pointing arrow, two vertical bars with small squares on top, and a right-pointing arrow.</p>
groundwater	<p>The signwriting for 'groundwater' consists of three rows of symbols. The top row has a circle above a vertical line with a small circle at the bottom, followed by two asterisks. The middle row has a wavy line above a vertical line with a small square at the bottom. The bottom row has a wavy line above a vertical line with a small circle at the bottom.</p>
group	<p>The signwriting for 'group' consists of two rows of symbols. The top row has a right-pointing arrow, two 'ee' symbols, and a left-pointing arrow. The bottom row has two '3' symbols.</p>
group	<p>The signwriting for 'group' consists of two rows of symbols. The top row has two right-pointing arrows. The bottom row has two vertical bars with small squares on top.</p>
group	<p>The signwriting for 'group' consists of two rows of symbols. The top row has two 'ff' symbols with a right-pointing arrow above the first one. The bottom row has two vertical bars with small squares on top.</p>
group	<p>The signwriting for 'group' consists of two rows of symbols. The top row has two 'ff' symbols with a right-pointing arrow above the first one. The bottom row has two vertical bars with small squares on top and an asterisk between them.</p>
group	<p>The signwriting for 'group' consists of two rows of symbols. The top row has two vertical bars with small squares on top and an asterisk between them. The bottom row has two right-pointing arrows above two vertical bars with small squares on top.</p>

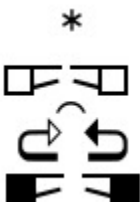
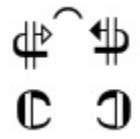
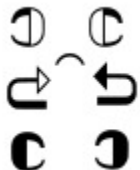
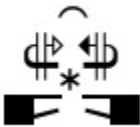
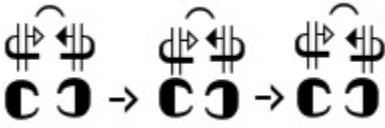
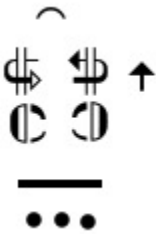

American Sign Language (ASL) Dictionary

Unedited 08082023

Spoken Word	SignWriting
group	 <p style="text-align: center;">*</p>
group	
group	
group	
Group of Hit Impact	
group-3	
group-3times	
group-cl	

American Sign Language (ASL) Dictionary

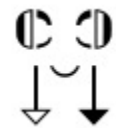
Unedited 08082023

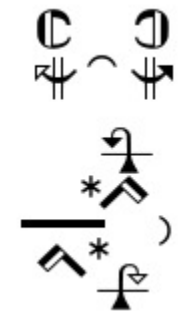
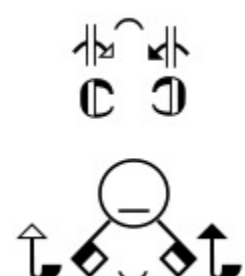
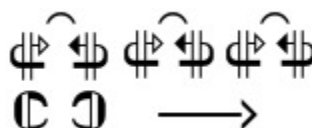
Spoken Word	SignWriting
group-come-here	
group-go-towards	
group-levite-	
group-responsibility	
group-success	
groups	







American Sign Language (ASL) Dictionary

Unedited 08082023

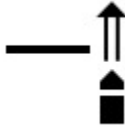
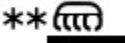
Spoken Word	SignWriting
groups	
groups	
groups	
groups	
grow	
grow up	
grow-up	



American Sign Language (ASL) Dictionary

Unedited 08082023

Spoken Word	SignWriting
grow-up	
grow-up	
grumble	
grumpy	
guarani	
guess	
guess	
guffaw	
guide	





American Sign Language (ASL) Dictionary

Unedited 08082023

Spoken Word	SignWriting
guide	
guilt	
guilty	

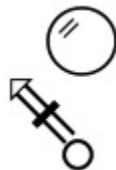
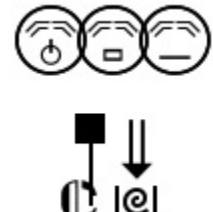



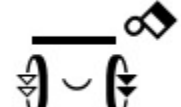



American Sign Language (ASL) Dictionary

Unedited 08082023

Spoken Word	SignWriting
guilty	
gullible	
gulp	
gum	
gum	
gun	
gym	
gym	



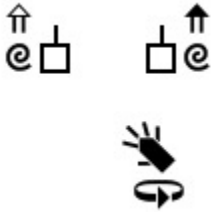

American Sign Language (ASL) Dictionary

Unedited 08082023

Spoken Word	SignWriting
gymnastics	
gymnastics	
H	
H	
habit	
habit	
habitat	
hack	
haha	

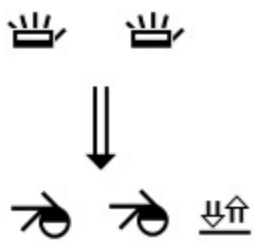
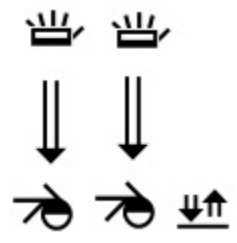
American Sign Language (ASL) Dictionary

Unedited 08082023

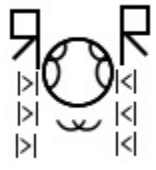
Spoken Word	SignWriting
haha	
Hail	
Hail	
hair	
hair	
hair	
hair cut	



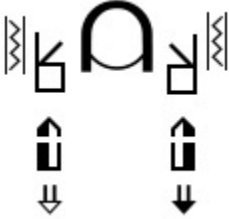
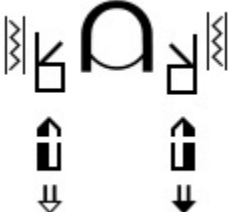
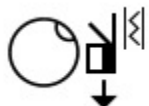
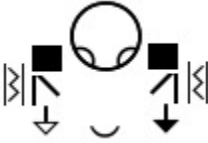
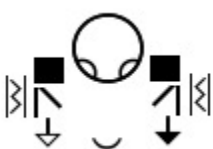
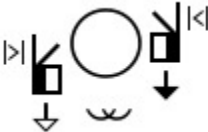

American Sign Language (ASL) Dictionary

Unedited 08082023

Spoken Word	SignWriting
hair dryer	
hair stylist	
haircut	
haircut	
haircut	
haircut	
haircut	

American Sign Language (ASL) Dictionary

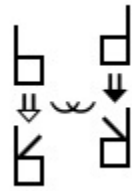
Unedited 08082023

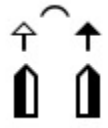
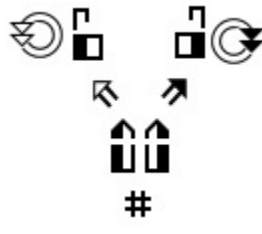
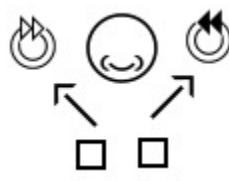
Spoken Word	SignWriting
haircut	
half	
half	
half half	
half hour	
hall	
hallelujah	
hallelujah	







American Sign Language (ASL) Dictionary

Unedited 08082023

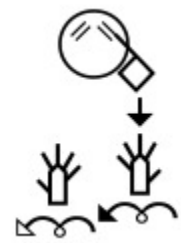
Spoken Word	SignWriting
hallowed	
Halloween	
Halloween	
Halloween Florida	
Halloween in Hawaii	
Halloween New York	
Halloween New York 2	
Halloween North Carolina	



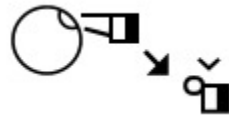



American Sign Language (ASL) Dictionary

Unedited 08082023

Spoken Word	SignWriting
Halloween North Dakota	
hallucination	
hallucinations	
halve	
ham	
Hamburg	
hamburger	

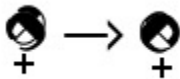

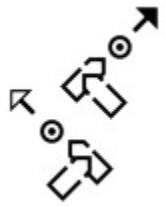

American Sign Language (ASL) Dictionary

Unedited 08082023

Spoken Word	SignWriting
hamburger	
hamburger	
hamburger	
hamburger	
hammer	
hand	
hand	
hand	



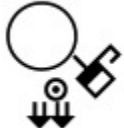
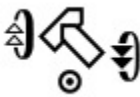

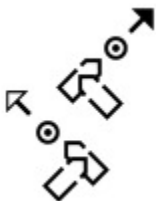

American Sign Language (ASL) Dictionary

Unedited 08082023

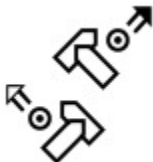
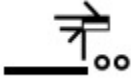
Spoken Word	SignWriting
hand (single)	
hand accident	
handball	
handkerchief	
hands	
hands	
hands	

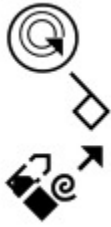



American Sign Language (ASL) Dictionary

Unedited 08082023

Spoken Word	SignWriting
hands	
hands off	
hands off	
handshapebopenthumb	
handsome	
handwave	
handwave	
handwave	
hang	

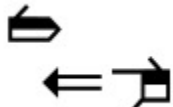
American Sign Language (ASL) Dictionary

Unedited 08082023

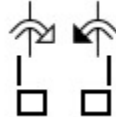
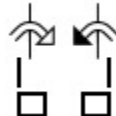
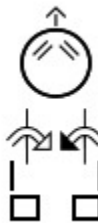
Spoken Word	SignWriting
hang-up-	
hangar	
hangout	
hangover	
Hanukah	
Hanukkah	
happen	
happen	
happen	





American Sign Language (ASL) Dictionary

Unedited 08082023

Spoken Word	SignWriting
happenings	
happily	
happy	
happy	
happy	
happy	
happy	
happy	
happy	

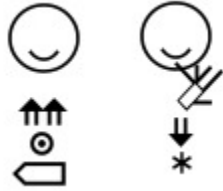







American Sign Language (ASL) Dictionary

Unedited 08082023

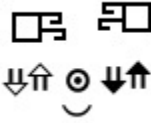
Spoken Word	SignWriting
Happy Birthday	
Happy Birthday	
Happy excitement ;-)	
harass	



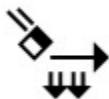



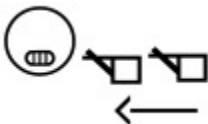

American Sign Language (ASL) Dictionary

Unedited 08082023

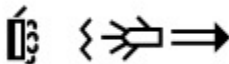
Spoken Word	SignWriting
hard	
hard	
hard	
hard	
hard	
hard hearted	
hard of hearing	
hard-of-hearing	







American Sign Language (ASL) Dictionary

Unedited 08082023

Spoken Word	SignWriting
Hardee	
harmonica	
harmony	
harp	
harsh	
harvest	
hassle	
hat	
hat	

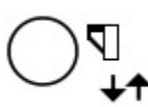

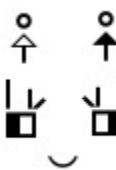

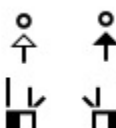

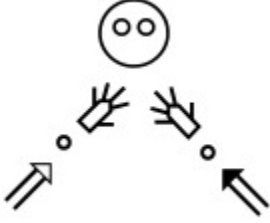

American Sign Language (ASL) Dictionary

Unedited 08082023

Spoken Word	SignWriting
hat	
hat	
Hat	
hatch	
hate	
hate	
hatred	







American Sign Language (ASL) Dictionary

Unedited 08082023

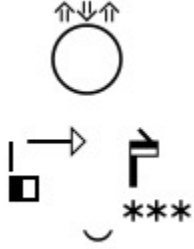
Spoken Word	SignWriting
haunt	
Haunt	
have	
have	
have	
have	
have	
have	

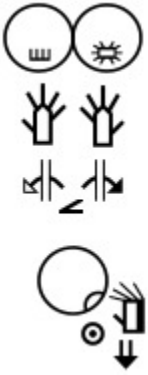

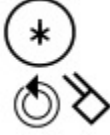





American Sign Language (ASL) Dictionary

Unedited 08082023

Spoken Word	SignWriting
have	
have	
have good evening	
have-done	
have-to	
Hawaii	
Hawaii	



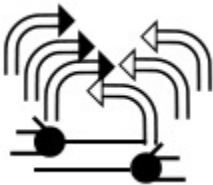



American Sign Language (ASL) Dictionary

Unedited 08082023

Spoken Word	SignWriting
Hawaii	
Hawaii	
Hawaii	
Hawaii	
Hawaiian	
hawk	
Hay	
hazard	





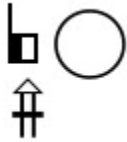
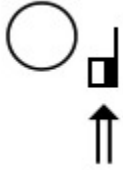

American Sign Language (ASL) Dictionary

Unedited 08082023

Spoken Word	SignWriting
hazy	
he	
he	
he	
he	
he	
he	
he	

American Sign Language (ASL) Dictionary

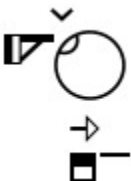
Unedited 08082023

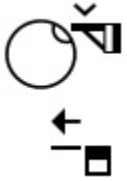
Spoken Word	SignWriting
he	
he (left)	
he (right)	
He - left hand - forward right	
He - left hand - to the right	
He - right hand - forward left	
He - right hand - to the left	









American Sign Language (ASL) Dictionary

Unedited 08082023

Spoken Word	SignWriting
he - straight ahead - left hand	<p>The sign is composed of three elements: a square with a diagonal line (top-left to bottom-right) and a checkmark above it, a circle to its right, and a square with a vertical line on its left side and an upward arrow below it.</p>
he - straight ahead - right hand	<p>The sign is composed of three elements: a circle on the left, a square with a diagonal line (top-left to bottom-right) and a checkmark above it to its right, and a square with a vertical line on its left side and an upward arrow below it.</p>
He lives (there) in America	
He lives in America	
He to the left - left hand	<p>The sign is composed of three elements: a square with a diagonal line (top-left to bottom-right) and a checkmark above it, a circle to its right, and a square with a diagonal line (top-left to bottom-right) and an upward arrow below it.</p>
He-above	<p>The sign is composed of two elements: a square with a vertical line on its left side and an upward arrow below it, and a circle below it containing two upward arrows.</p>
He-above	<p>The sign is composed of three elements: a circle on the left, a square with a vertical line on its left side and an upward arrow below it to its right, and a tilde symbol above the square.</p>
he-above	<p>The sign is composed of two elements: a square with a vertical line on its left side and an upward arrow below it, and a circle below it containing two upward arrows.</p>



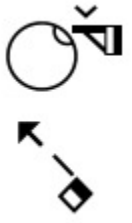



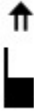

American Sign Language (ASL) Dictionary

Unedited 08082023

Spoken Word	SignWriting
he-down-right	
he-down-right	
He-God	
he-left	
he-left	
he-or-she	
he-right	
he-to-the-left	
He-up-right	









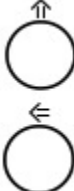

American Sign Language (ASL) Dictionary

Unedited 08082023

Spoken Word	SignWriting
He_God	
head	
head	
head	
head	
head body shift right	
head forward eyebrows up	
head jerk	
head jerk forward	

American Sign Language (ASL) Dictionary

Unedited 08082023

Spoken Word	SignWriting
head move	
head nod	
head on collision	
head on collision	
head shake	
head tilt forward	
head tilt left	
head tilt right	
head up squint eyes	
head-neg	







American Sign Language (ASL) Dictionary

Unedited 08082023

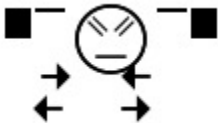
Spoken Word	SignWriting
<p style="text-align: center;">head-over-heels</p>	<p>The SignWriting for 'head-over-heels' consists of three parts: a vertical line with an asterisk at the top, a 'C' shape with a hand symbol pointing right, and a horizontal line with a square at the end.</p>
<p style="text-align: center;">head-up</p>	<p>The SignWriting for 'head-up' is a circle with an upward-pointing arrow above it.</p>



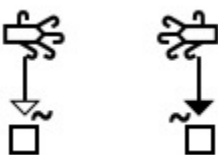

American Sign Language (ASL) Dictionary

Unedited 08082023

Spoken Word	SignWriting
headache	
headache	
headache	
headnod	
headnod-slow	
headnod-smile	
headtilt right	
headturn-R	
heal	

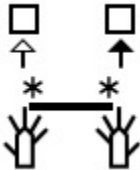
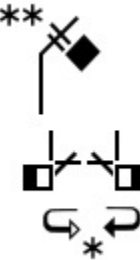
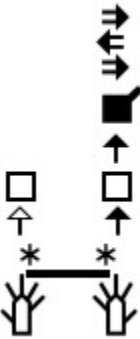
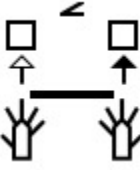





American Sign Language (ASL) Dictionary

Unedited 08082023

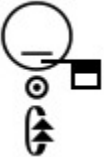
Spoken Word	SignWriting
health	
health clinic	
health insurance	
healthy	
hear	
hear	
hearing	

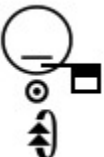
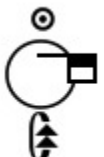

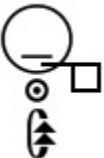



American Sign Language (ASL) Dictionary

Unedited 08082023

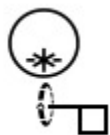
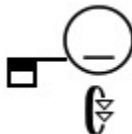
Spoken Word	SignWriting
hearing	
hearing	
hearing	
hearing	
hearing aid	
hearing aid	
hearing person	
hearing person	

American Sign Language (ASL) Dictionary

Unedited 08082023

Spoken Word	SignWriting
hearing person	
hearing person	
hearing-left	
heart	
heart	
heart	
heart	
heart	





American Sign Language (ASL) Dictionary

Unedited 08082023

Spoken Word	SignWriting
heart	<p>The SignWriting symbol for 'heart' consists of two mirrored hand shapes at the top, each with a curved arrow pointing towards the center. Below these are two vertical lines, and at the bottom are two asterisks.</p>
heart	<p>The SignWriting symbol for 'heart' features a hand shape with a curved arrow pointing downwards and to the left. Below it is another hand shape with a curved arrow pointing downwards and to the right, and an asterisk at the bottom.</p>
heart attack	<p>The SignWriting symbol for 'heart attack' shows a hand shape with a curved arrow pointing downwards and to the right. Below it is a square with a hash symbol inside, followed by an upward-pointing arrow, and another hand shape with a curved arrow pointing downwards and to the right, and an asterisk at the bottom.</p>
heart beat	<p>The SignWriting symbol for 'heart beat' depicts a hand shape with a curved arrow pointing downwards and to the right. Below it is a square with a hash symbol inside, and a small upward-pointing arrow at the bottom.</p>
heart beat	<p>The SignWriting symbol for 'heart beat' shows a hand shape with a curved arrow pointing downwards and to the right. Below it is a vertical line with a downward-pointing arrow, and another hand shape with a curved arrow pointing downwards and to the right.</p>
heart-break	<p>The SignWriting symbol for 'heart-break' features a hand shape with a curved arrow pointing downwards and to the right. Below it is a square with a hash symbol inside, and another square with a downward-pointing arrow below that.</p>
heartbreak	<p>The SignWriting symbol for 'heartbreak' consists of a circle with a horizontal line through it at the top. Below it are two diamonds, one white and one black. At the bottom are two hand shapes with curved arrows pointing downwards and outwards, and a small '2' between them.</p>

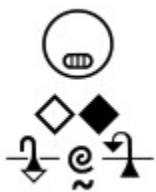



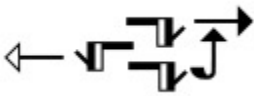
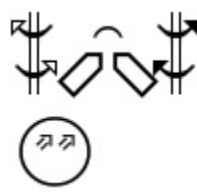
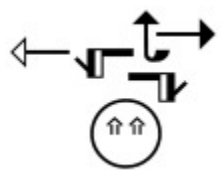

American Sign Language (ASL) Dictionary

Unedited 08082023

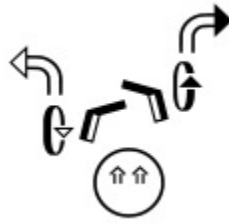
Spoken Word	SignWriting
HEARTBREAK	
heat	
heat	
Heather	
heaven	
heaven	
heaven	

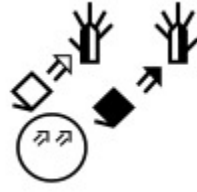

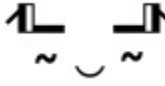



American Sign Language (ASL) Dictionary

Unedited 08082023

Spoken Word	SignWriting
heaven	
heaven	
heavenly	
Heavenly-Father	
heavy	
heavy	
heavy	

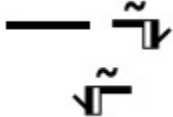





American Sign Language (ASL) Dictionary

Unedited 08082023

Spoken Word	SignWriting
heavy rain	
Hebrews	
height	
helicopter	
helicopter	
helicopter-left	
hell	

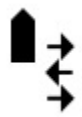





American Sign Language (ASL) Dictionary

Unedited 08082023

Spoken Word	SignWriting
hell	
Hello	
Hello	
Hello	
Hello	
hello	
hello	
hello	
hello	
hello	
hello	





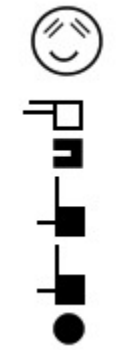

American Sign Language (ASL) Dictionary

Unedited 08082023

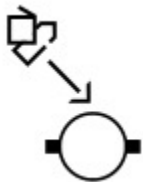
Spoken Word	SignWriting
hello	
hello	
hello	
hello	
hello	
hello	
hello	

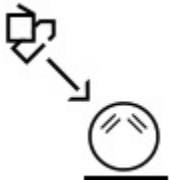
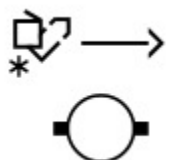

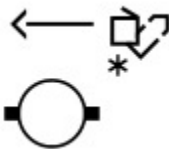



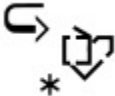

American Sign Language (ASL) Dictionary

Unedited 08082023

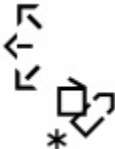
Spoken Word	SignWriting
helmet	
help	
help	
help	
help	
help	
help	
help	



American Sign Language (ASL) Dictionary

Unedited 08082023

Spoken Word	SignWriting
help	
help	
help	
help	
help	
help	
help	
help	
help	



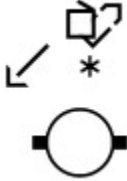
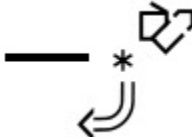
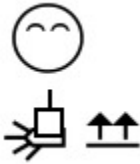



American Sign Language (ASL) Dictionary

Unedited 08082023

Spoken Word	SignWriting
help	
help	
help	
help	
help	



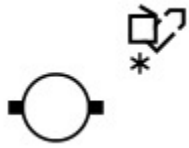
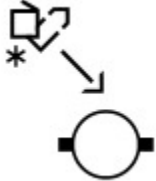



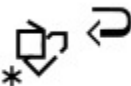

American Sign Language (ASL) Dictionary

Unedited 08082023

Spoken Word	SignWriting
help	
help	
help	
help	
help	
help	
help	
help	





American Sign Language (ASL) Dictionary

Unedited 08082023

Spoken Word	SignWriting
help	
help	
help	
help (2) you help me	
help (2) you help me	
help (v) they help me	
help (v) to help	
help all of you	
help all of you	

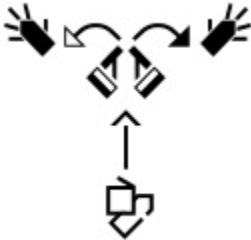



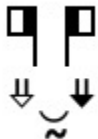
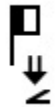
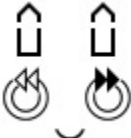
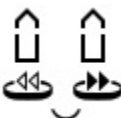

American Sign Language (ASL) Dictionary

Unedited 08082023

Spoken Word	SignWriting
help all over	
helping	
hen	
here	
here	
here	
here	
here	

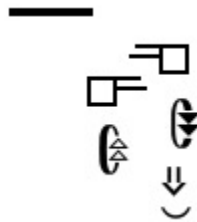
American Sign Language (ASL) Dictionary

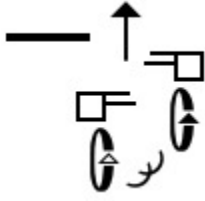
Unedited 08082023

Spoken Word	SignWriting
here	
here	
heredity	
heredity	
heredity	
hers (right)	







American Sign Language (ASL) Dictionary

Unedited 08082023

Spoken Word	SignWriting
Hers-left hand	<p>The signwriting consists of a circle with a small circle inside it, positioned above a square with a vertical line through its center. Below this is a right-pointing arrow, and at the bottom is a solid black vertical bar.</p>
hers-to-the-left	<p>The signwriting consists of a circle with two left-pointing arrows inside it, positioned above a square with a vertical line through its center. Below this is a downward-pointing arrow, and at the bottom is a right-pointing arrow and a solid black vertical bar.</p>
hers-to-the-right	<p>The signwriting consists of a circle with two right-pointing arrows inside it, positioned above a square with a vertical line through its center. Below this is a right-pointing arrow and a solid black vertical bar.</p>
hesitate	<p>The signwriting consists of a circle with a wavy mouth and closed eyes, positioned above two hands with fingers spread. Two arrows point upwards and to the right from the hands.</p>
heterosexual	<p>The signwriting consists of a circle with an asterisk inside it, positioned above a house icon. A right-pointing arrow is to the right of the house icon.</p>
heterozygous	<p>The signwriting consists of two squares with vertical lines through their centers, one on the left and one on the right. Below each square is an upward-pointing arrow. A wavy mouth is positioned between the two upward-pointing arrows.</p>
hey	<p>The signwriting consists of a circle with a wavy mouth inside it, positioned below two upward-pointing arrows. A right-pointing arrow is positioned below the right upward-pointing arrow.</p>

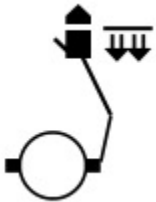
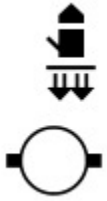

American Sign Language (ASL) Dictionary

Unedited 08082023

Spoken Word	SignWriting
hey	
hey	
hey	
hey	
hey	
hey	
hey there	



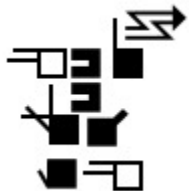
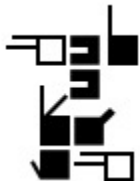
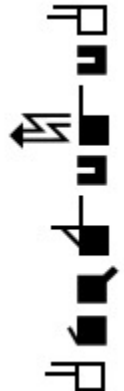

American Sign Language (ASL) Dictionary

Unedited 08082023

Spoken Word	SignWriting
hey there (person on left)	 <p>The signwriting consists of a circle with two left-pointing arrows inside, positioned above a diagonal line that ends in a hook. Below this, there are three horizontal lines with downward-pointing arrows.</p>
Hezekiah	 <p>The signwriting is a vertical sequence of symbols: a square with a horizontal line above it, a square with a horizontal line below it, a square with a horizontal line above it, a square with a horizontal line below it, and a square with a horizontal line above it.</p>
Hezekiah	 <p>The signwriting is a vertical sequence of symbols: a square with a horizontal line above it, a square with a horizontal line below it, a square with a horizontal line above it, a square with a horizontal line below it, and a square with a horizontal line above it.</p>
Hezekiah	 <p>The signwriting is a vertical sequence of symbols: a square with a horizontal line above it, a square with a horizontal line below it, a square with a horizontal line above it, a square with a horizontal line below it, a square with a horizontal line above it, a square with a horizontal line below it, a square with a horizontal line above it, and a square with a horizontal line below it.</p>
Hezekiah	 <p>The signwriting is a vertical sequence of symbols: a square with a horizontal line above it, a square with a horizontal line below it, a square with a horizontal line above it, a square with a horizontal line below it, a square with a horizontal line above it, a square with a horizontal line below it, a square with a horizontal line above it, and a square with a horizontal line below it.</p>

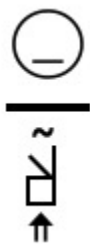

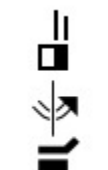
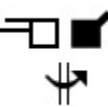

American Sign Language (ASL) Dictionary

Unedited 08082023

Spoken Word	SignWriting
HH	
hi	
hi	
hi	
hi	
hi	
hi	
hi!	

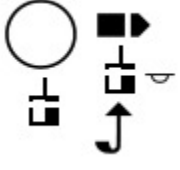
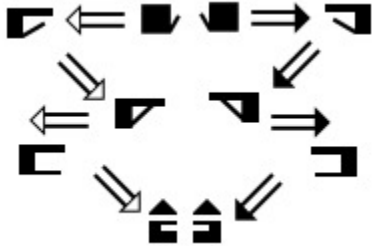

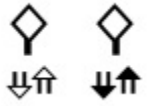

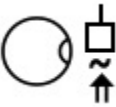
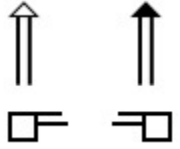

American Sign Language (ASL) Dictionary

Unedited 08082023

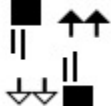
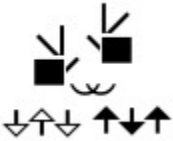
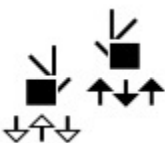
Spoken Word	SignWriting
hiccup	
hide	
hierarchy	
high	
high heels	
high school	
higher	
Highest	









American Sign Language (ASL) Dictionary

Unedited 08082023

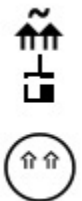
Spoken Word	SignWriting
highway	
highway	
hiking	
hiking	
hill	
hill	
hill	
him-left	
him-to-the-right	



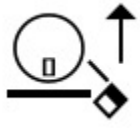

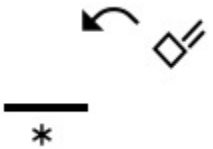
American Sign Language (ASL) Dictionary

Unedited 08082023

Spoken Word	SignWriting
himself	
himself	
himself	
himself	
himself (left)	
himself (right)	
hindsight	
hippo	
hire	

American Sign Language (ASL) Dictionary

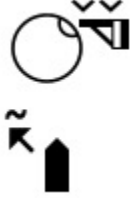
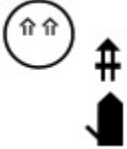
Unedited 08082023

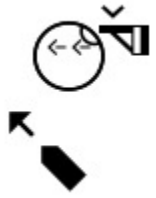
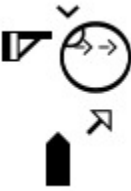
Spoken Word	SignWriting
His	
his	
his (left)	
his above	
His Almighty	
his-to-the-left	
his-to-the-right	

American Sign Language (ASL) Dictionary

Unedited 08082023

Spoken Word	SignWriting
historian	
historian	
historian	
history	
history	
history	
history	
hit	









American Sign Language (ASL) Dictionary

Unedited 08082023

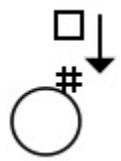
Spoken Word	SignWriting
hit	



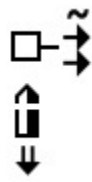



American Sign Language (ASL) Dictionary

Unedited 08082023

Spoken Word	SignWriting
hit	
hit	
hit	
hit-head	
hit-stone	
hitch - trailer	
hitchhike	
hitchhiker	
hoarse	
hockey	







American Sign Language (ASL) Dictionary

Unedited 08082023

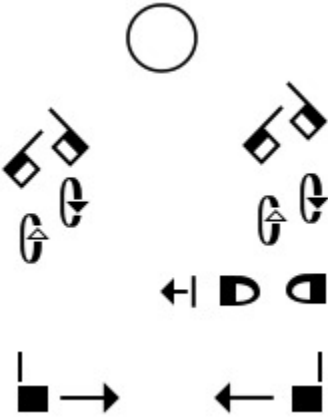
Spoken Word	SignWriting
hockey	
hold	
hold	
hold	
hold	
hold a grudge	

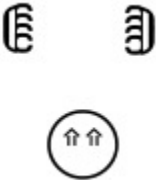
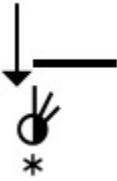







American Sign Language (ASL) Dictionary

Unedited 08082023

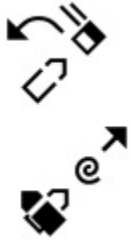
Spoken Word	SignWriting
HOLD REDUCTION	
hold-on	
hold-with-joy	
hole-in-heart	
Holland	
Holland	
Holly	

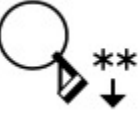





American Sign Language (ASL) Dictionary

Unedited 08082023

Spoken Word	SignWriting
Holly Sharer	
Hollywood	
holy	
home	
home	
home	
home	
home	





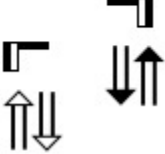

American Sign Language (ASL) Dictionary

Unedited 08082023

Spoken Word	SignWriting
home	
home	
home	
home	
home-left	
home-right	
homeostasis	 



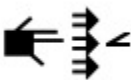

American Sign Language (ASL) Dictionary

Unedited 08082023

Spoken Word	SignWriting
homework	
homework	
homozygous dominant	
homozygous recessive	
honest	
honestly!	
honey	
Hong Kong	

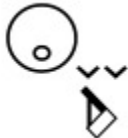

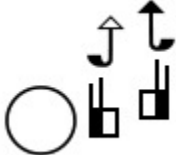
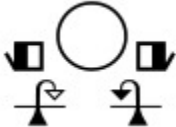

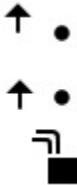
American Sign Language (ASL) Dictionary

Unedited 08082023

Spoken Word	SignWriting
Hong Kong	
honk	
Honolulu, Hawaii	
honor	
hood	
hooked	
hooray	
hop	

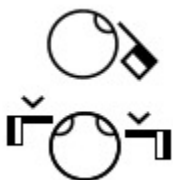
American Sign Language (ASL) Dictionary

Unedited 08082023

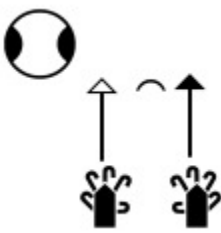
Spoken Word	SignWriting
hope	
hope	
hope	
Hope	
hopscotch	
hopscotch rules	
horde	

American Sign Language (ASL) Dictionary

Unedited 08082023

Spoken Word	SignWriting
horoscope	
horrible	
horrified	
horse	
horse	
horse	

American Sign Language (ASL) Dictionary

Unedited 08082023

Spoken Word	SignWriting
hose	<p>The signwriting for 'hose' consists of two parts. The top part features a central circle with a counter-clockwise rotation arrow, flanked by two upward-pointing arrows. Below this is a square with a vertical line extending downwards from its center.</p>
hose	<p>The signwriting for 'hose' consists of two parts. The top part features a central circle with a counter-clockwise rotation arrow, flanked by two upward-pointing arrows. Below this is a square with a vertical line extending downwards from its center.</p>
hospital	<p>The signwriting for 'hospital' consists of a horizontal line at the top. Below it is a square with a vertical line extending downwards from its center, ending in a downward-pointing arrow. To the left of the vertical line is a circle with a counter-clockwise rotation arrow.</p>
hospital	<p>The signwriting for 'hospital' consists of a horizontal line at the top. Below it is a square with a vertical line extending downwards from its center, ending in a downward-pointing arrow. To the left of the vertical line is a circle with a counter-clockwise rotation arrow.</p>
hospital	<p>The signwriting for 'hospital' consists of a horizontal line at the top. Below it is a square with a vertical line extending downwards from its center, ending in a downward-pointing arrow. To the left of the vertical line is a circle with a counter-clockwise rotation arrow.</p>
hospital	<p>The signwriting for 'hospital' consists of a horizontal line at the top. Below it is a square with a vertical line extending downwards from its center, ending in a downward-pointing arrow. To the left of the vertical line is a circle with a counter-clockwise rotation arrow.</p>
hospital gown	<p>The signwriting for 'hospital gown' consists of two parts. The top part is identical to the signwriting for 'hospital'. The bottom part features a horizontal line with two downward-pointing arrows at its ends, one on each side.</p>







American Sign Language (ASL) Dictionary

Unedited 08082023

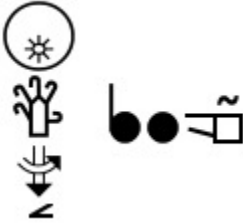
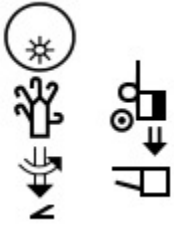
Spoken Word	SignWriting
host	
hostage	
hostile	
hot	
hot	
hot dog	
hot game	
hotdog	
hotdog	







American Sign Language (ASL) Dictionary

Unedited 08082023

Spoken Word	SignWriting
hotdog	
hotdog	
hotdog	
hotel	
hotel	
hour	
hour	
hour	

American Sign Language (ASL) Dictionary

Unedited 08082023

Spoken Word	SignWriting
hour-5	
hourly	
house	
house	
house	
house	
Houston	





American Sign Language (ASL) Dictionary

Unedited 08082023

Spoken Word	SignWriting
How	<p>The SignWriting for 'How' consists of a circle with two horizontal lines inside, representing the mouth. Below this are two hands. The left hand is in a '5' position (all fingers extended) with the palm facing left. The right hand is in a '5' position with the palm facing right. Both hands are positioned as if they are about to move towards each other.</p>
how	<p>The SignWriting for 'how' consists of a circle with two horizontal lines inside, representing the mouth. Below this are two hands. The left hand is in a '5' position with the palm facing left. The right hand is in a '5' position with the palm facing right. Both hands are positioned as if they are about to move towards each other.</p>

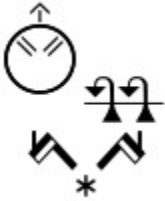
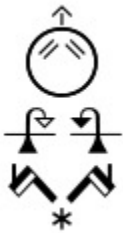

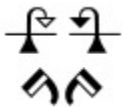
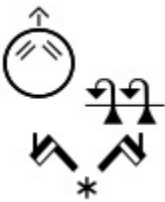
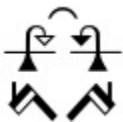



American Sign Language (ASL) Dictionary

Unedited 08082023

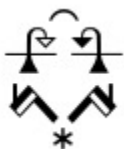
Spoken Word	SignWriting
how	
how	
how	
how	
how	
how	
how	

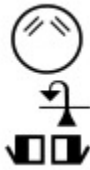
American Sign Language (ASL) Dictionary

Unedited 08082023

Spoken Word	SignWriting
how	
how	
how	
how	
how	
how annoying	
How are you?	



American Sign Language (ASL) Dictionary

Unedited 08082023

Spoken Word	SignWriting
how are you?	<p>The signwriting consists of three main components arranged vertically. At the top is a circle with two diagonal lines inside and an upward-pointing arrow above it. Below this is a hand symbol with fingers spread, a curved arrow indicating a clockwise rotation, and a small asterisk below the hand. At the bottom is a square with an upward-pointing arrow above it.</p>
how are you?	<p>The signwriting consists of three main components arranged vertically. At the top is a circle with two diagonal lines inside and an upward-pointing arrow above it. Below this is a hand symbol with fingers spread, a curved arrow indicating a clockwise rotation, and a small asterisk below the hand. At the bottom is a square with an upward-pointing arrow above it.</p>
how many	<p>The signwriting consists of three main components arranged vertically. At the top is a circle with two diagonal lines inside and an upward-pointing arrow above it. Below this are two hand symbols, one on the left and one on the right, both with fingers spread. Below each hand symbol is a square with an upward-pointing arrow above it.</p>
How old?	<p>The signwriting consists of two main components arranged vertically. At the top is a circle with two diagonal lines inside and a small dot to its left. Below this is a double-headed vertical arrow pointing both up and down.</p>
how old?	<p>The signwriting consists of three main components arranged vertically. At the top is a circle with two diagonal lines inside and an upward-pointing arrow above it. Below this is a square with an upward-pointing arrow above it. At the bottom is a hand symbol with fingers spread and a double-headed vertical arrow pointing both up and down.</p>

American Sign Language (ASL) Dictionary

Unedited 08082023

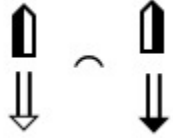
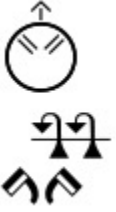
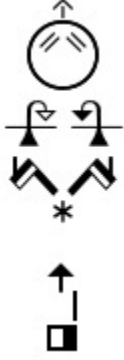
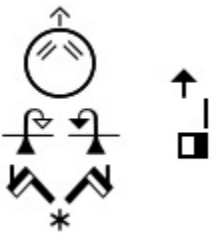
Spoken Word	SignWriting
how old?	
how shocking	
How to play tic-tac-toe	
how-2	
how-are-you	
how-are-you	





American Sign Language (ASL) Dictionary

Unedited 08082023

Spoken Word	SignWriting
how-are-you	<p>The SignWriting for 'how-are-you' consists of three symbols: a circle with two slanted lines inside representing eyes, two crossed hands with fingers pointing outwards, and a double-lined upward arrow.</p>
how-many	<p>The SignWriting for 'how-many' consists of four symbols: a circle with two slanted lines inside representing eyes and an upward arrow above it, two hands with fingers pointing outwards, and two squares with an upward arrow between them.</p>
how-many	<p>The SignWriting for 'how-many' consists of four symbols: a circle with two slanted lines inside representing eyes, two hands with fingers pointing outwards, and two squares with an upward arrow between them.</p>
how-much	<p>The SignWriting for 'how-much' consists of four symbols: a circle with two slanted lines inside representing eyes and an upward arrow above it, two hands with fingers pointing outwards, and two squares with an upward arrow between them.</p>
how-often	<p>The SignWriting for 'how-often' consists of five symbols: a circle with two slanted lines inside representing eyes and an upward arrow above it, a hand with fingers pointing outwards, three asterisks arranged in a triangle, a hand with fingers pointing outwards, and an upward arrow.</p>



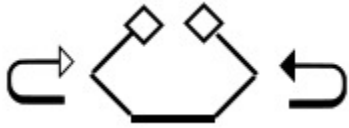
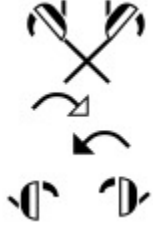



American Sign Language (ASL) Dictionary

Unedited 08082023

Spoken Word	SignWriting
how-to-deal	
however	
however	
hug	
hug	
hug	
hug	



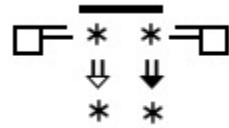
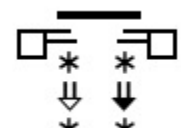



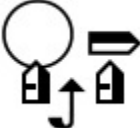

American Sign Language (ASL) Dictionary

Unedited 08082023

Spoken Word	SignWriting
huh?	
huh?	
huh?	
hula-fish	
hum	
human	
human	
human being	







American Sign Language (ASL) Dictionary

Unedited 08082023

Spoken Word	SignWriting
humble	
humble	
humble	
Humpty-Dumpty	
hundred	
hundred	
hundred	
hundreds	



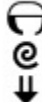
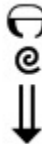

American Sign Language (ASL) Dictionary

Unedited 08082023

Spoken Word	SignWriting
Hungarian	
Hungary	
Hungary	
Hungary	
Hungary	
hungry	
hungry	
hungry	

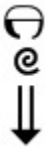
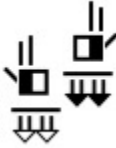

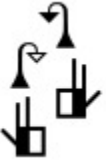
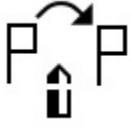
American Sign Language (ASL) Dictionary

Unedited 08082023

Spoken Word	SignWriting
hungry	
hunt	
hunter	
hunting	
hurdle	
hurray	
hurricane	

American Sign Language (ASL) Dictionary

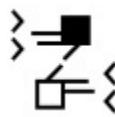
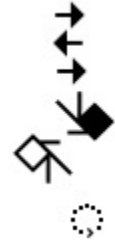
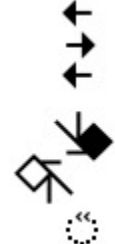
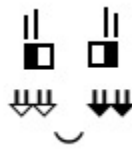
Unedited 08082023

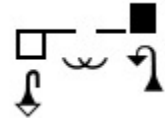
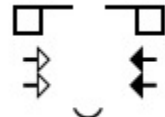
Spoken Word	SignWriting
hurricane	
Hurricane	
Hurricane	
hurry	
hurry	
hurry	
hurt	
hurt	





American Sign Language (ASL) Dictionary

Unedited 08082023

Spoken Word	SignWriting
hurt	<p>The SignWriting for 'hurt' consists of a square on the left, a square on the right, a downward arrow from the left square, a downward arrow from the right square, a curved line between the two arrows, and a square on the left with a horizontal line extending to the right.</p>
hurt	<p>The SignWriting for 'hurt' consists of a square on the left with an upward arrow, a square on the right with a downward arrow, a square on the left with a horizontal line extending to the right, and a square on the right with a downward arrow.</p>
hurts	<p>The SignWriting for 'hurts' consists of a square on the left with a downward arrow, a square on the right with a downward arrow, a curved line between the two arrows, and a square on the right with a downward arrow.</p>
Husband	<p>The SignWriting for 'Husband' consists of a circle with an asterisk, a downward arrow from the circle, a double-lined arrow pointing down and to the right, and a circle with a slash through it.</p>
husband	<p>The SignWriting for 'husband' consists of a circle with an asterisk, a downward arrow from the circle, a double-lined arrow pointing down and to the right, a plus sign, and a circle with a slash through it.</p>
husband	<p>The SignWriting for 'husband' consists of a circle with an asterisk, a downward arrow from the circle, a double-lined arrow pointing down and to the right, a plus sign, and a circle with a slash through it.</p>
husband	<p>The SignWriting for 'husband' consists of a circle with an asterisk, a downward arrow from the circle, a double-lined arrow pointing down and to the right, a plus sign, and a circle with a slash through it.</p>





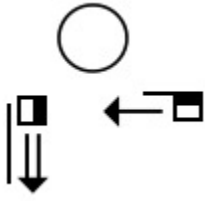

American Sign Language (ASL) Dictionary

Unedited 08082023

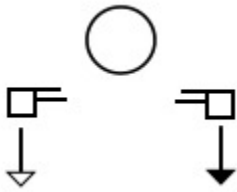
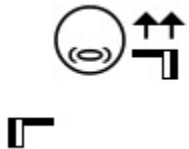
Spoken Word	SignWriting
husband	
husband	
husband	
husband ASL	
husband with mouth	
Husk	

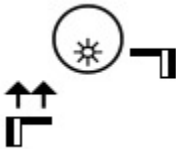
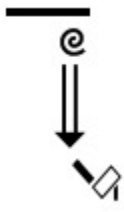

American Sign Language (ASL) Dictionary

Unedited 08082023

Spoken Word	SignWriting
hygiene	
hypertonic	
Hyphen	
hypocrite	
hypothesis	
hypotonic	
I	
I	
I	











American Sign Language (ASL) Dictionary

Unedited 08082023

Spoken Word	SignWriting
I (africa)	 The SignWriting symbol for 'I (africa)' consists of a stylized letter 'I' with a diagonal line through it, positioned above two asterisks (**).
I - left hand - fingerspelling	 The SignWriting symbol for 'I - left hand - fingerspelling' is a square with a diagonal line from the bottom-left to the top-right.





American Sign Language (ASL) Dictionary

Unedited 08082023

Spoken Word	SignWriting
I am	
I hate you	
i love you	
I love you	
I love you	
I love you forever.	
I really love you.	
I see	
I understand	
I understand well	



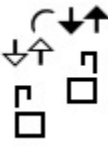
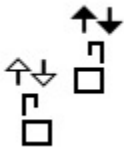

American Sign Language (ASL) Dictionary

Unedited 08082023

Spoken Word	SignWriting
I'm	
I'm not	
I-join-you	
I/ME HAPPY I/ME	
ice cream	
ice cream	
ice skates	
ice skating	

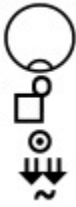

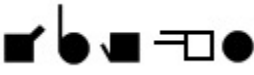
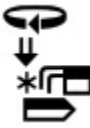
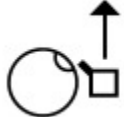

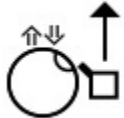



American Sign Language (ASL) Dictionary

Unedited 08082023

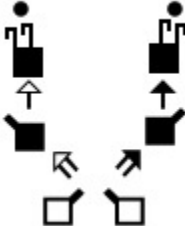
Spoken Word	SignWriting
Iceland	
Icelandic	
icons in a vertical column	
Idaho	
Idaho	
idea	
idea	
idea with headnod	

American Sign Language (ASL) Dictionary

Unedited 08082023

Spoken Word	SignWriting
ideas	
identical	
idiom	
idle	
idol	
if	
if	
If	









American Sign Language (ASL) Dictionary

Unedited 08082023

Spoken Word	SignWriting
if not	<p>The signwriting consists of two parts. The first part is a square with a diagonal line from the top-left to the bottom-right, and a circle with a vertical line through its center. The second part is a circle with two horizontal lines inside, a square with a vertical line through its center, and a small circle with a dot in the center, all arranged vertically with an upward-pointing arrow to the right.</p>
ignorant	<p>The signwriting consists of a circle with a horizontal line through its center, a small circle with a dot in the center, and a hash symbol (#) to the right.</p>
ignorant	<p>The signwriting consists of a square with a diagonal line from the top-left to the bottom-right, a small circle with a dot in the center, a square with a vertical line through its center, and an upward-pointing arrow.</p>
ignorant	<p>The signwriting consists of a circle with a horizontal line through its center, a small circle with a dot in the center, a square with a diagonal line from the top-left to the bottom-right, and a downward-pointing arrow.</p>
ignore	<p>The signwriting consists of a circle with a horizontal line through its center and a small circle with a dot in the center, a square with a diagonal line from the top-left to the bottom-right, and two arrows pointing away from each other.</p>
ignore	<p>The signwriting consists of a circle with a horizontal line through its center and a small circle with a dot in the center, a square with a diagonal line from the top-left to the bottom-right, and two arrows pointing away from each other.</p>
ill	<p>The signwriting consists of a circle with a horizontal line through its center and a small circle with a dot in the center, a square with a diagonal line from the top-left to the bottom-right, a square with a vertical line through its center, and two asterisks (**).</p>
Ill	<p>The signwriting consists of a square with a diagonal line from the top-left to the bottom-right, a square with a vertical line through its center, and an arrow pointing to the right.</p>





American Sign Language (ASL) Dictionary

Unedited 08082023

Spoken Word	SignWriting
illegal	
illegal	
Illinois	
Illinois	
image	
imagine	
imagine	
imagine	
immense	

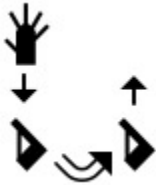
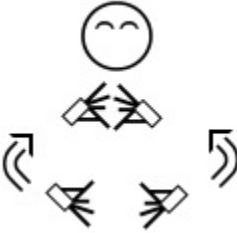

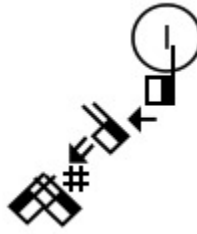



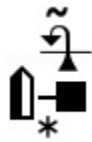

American Sign Language (ASL) Dictionary

Unedited 08082023

Spoken Word	SignWriting
impair	
import data	
importance	
impossible	
impossible	
imposter	
impress	

American Sign Language (ASL) Dictionary

Unedited 08082023

Spoken Word	SignWriting
impressive	
improve	
improve	
improve	
in	
in	
in	
in	





American Sign Language (ASL) Dictionary

Unedited 08082023

Spoken Word	SignWriting
in a few days	<p>The SignWriting symbol consists of a circle with an asterisk inside, a diamond shape, and a hand with fingers spread. A curved arrow points from the hand towards the circle and diamond.</p>
in red	<p>The SignWriting symbol shows a hand with the index finger pointing down, and a red pencil positioned above it.</p>
in two weeks	<p>The SignWriting symbol includes a circle with an up arrow and a down arrow above it, a hand with fingers spread, and a musical note.</p>
in-2	<p>The SignWriting symbol features a hand with fingers spread, a diamond shape, and an asterisk.</p>
in-my-heart	<p>The SignWriting symbol shows a hand with fingers spread, a diamond shape, and an asterisk.</p>
inaugural	<p>The SignWriting symbol consists of two vertical bars with upward-pointing arrows, and a small house-like shape to the right.</p>
inauguration	<p>The SignWriting symbol shows a hand with the index finger pointing down, and a small house-like shape below it.</p>

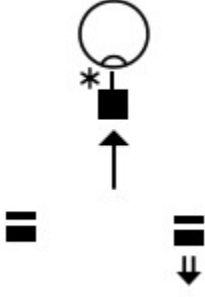

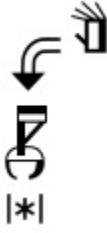
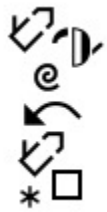

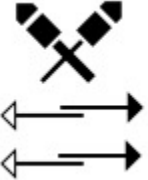
American Sign Language (ASL) Dictionary

Unedited 08082023

Spoken Word	SignWriting
incapable	
inch	
include	
income	
income	
incomplete-pass	



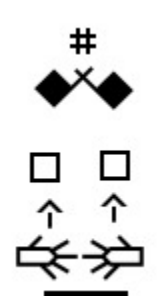
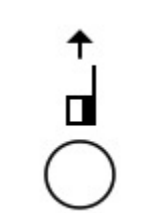
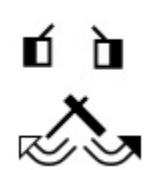

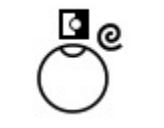



American Sign Language (ASL) Dictionary

Unedited 08082023

Spoken Word	SignWriting
increase	
increase	
increase	
incurable	
Indeed	
independence	
independence	
India	

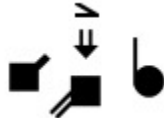
American Sign Language (ASL) Dictionary

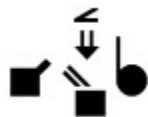
Unedited 08082023

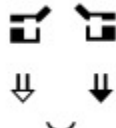
Spoken Word	SignWriting
India	
Indian	
Indian (India)	
Indian Ocean	
Indiana	
Indiana	
Indiana	
Indiana	
indicate	
individual	

American Sign Language (ASL) Dictionary

Unedited 08082023

Spoken Word	SignWriting
indoctrinate	<p>The SignWriting symbol for 'indoctrinate' consists of a central circle. Above the circle are two sets of three arrows: the left set has arrows pointing up, down, and up; the right set has arrows pointing up, down, and up. To the left of the circle is a solid black circle, and to the right is another solid black circle. Below the circle is a solid black circle.</p>
Indonesia	<p>The SignWriting symbol for 'Indonesia' consists of a sequence of four square boxes. The first box has an arrow pointing right. The second box has an arrow pointing right and a diagonal slash. The third box has an arrow pointing right. The fourth box has an arrow pointing right and a diagonal slash.</p>
Indonesia	<p>The SignWriting symbol for 'Indonesia' consists of a square box with an arrow pointing right, followed by a double-lined arrow pointing right. Above the double-lined arrow are four small downward-pointing chevrons.</p>







American Sign Language (ASL) Dictionary

Unedited 08082023

Spoken Word	SignWriting
industry	<p>The signwriting for 'industry' consists of a circle containing a square with a smaller square inside it, and a vertical line with an arrow pointing up. To the right of this symbol are three arrows pointing right, stacked vertically.</p>
infant	<p>The signwriting for 'infant' consists of a circle containing two arrows pointing down. Below this is a horizontal line with a square in the middle, and arrows pointing left and right from the square.</p>
infant	<p>The signwriting for 'infant' consists of a horizontal line with a square in the middle, and arrows pointing left and right from the square. Above the line is a square with an arrow pointing left, and below the line is a square with an arrow pointing right. A star is placed above the left square and below the right square.</p>
infant	<p>The signwriting for 'infant' consists of a horizontal line with a square in the middle, and arrows pointing left and right from the square. Above the line is a square with an arrow pointing left, and below the line is a square with an arrow pointing right. A star is placed above the left square.</p>
infantile	<p>The signwriting for 'infantile' consists of a horizontal line with a square in the middle, and arrows pointing left and right from the square. Above the line is a square with an arrow pointing left, and below the line is a square with an arrow pointing right. A star is placed above the left square.</p>
infection	<p>The signwriting for 'infection' consists of a circle containing two parallel horizontal lines. To the right of this symbol is a square with an arrow pointing up, and three arrows pointing right, stacked vertically.</p>
inferior	<p>The signwriting for 'inferior' consists of a horizontal line with a square in the middle, and arrows pointing left and right from the square. Below the line is a square with an arrow pointing right.</p>
INFIRMITY	<p>The signwriting for 'INFIRMITY' consists of a circle containing two parallel horizontal lines. To the right of this symbol is a square with an arrow pointing up, and three arrows pointing right, stacked vertically. Below this is a square with an arrow pointing left, and a star is placed below the square.</p>

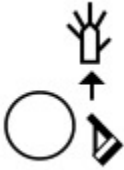





American Sign Language (ASL) Dictionary

Unedited 08082023

Spoken Word	SignWriting
infirmity	
influence	
inform	
inform	
inform	
inform	
inform-all	

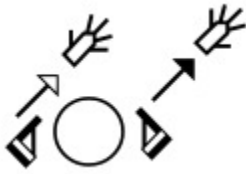

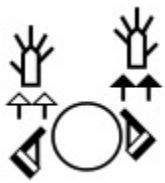

American Sign Language (ASL) Dictionary

Unedited 08082023

Spoken Word	SignWriting
inform-all	
inform-me	
inform-R	
information	
information	
information	
information	



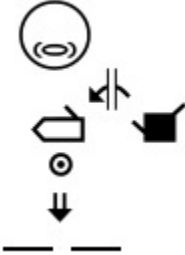
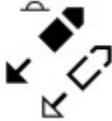

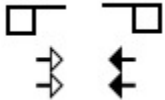
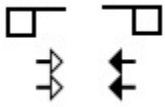

American Sign Language (ASL) Dictionary

Unedited 08082023

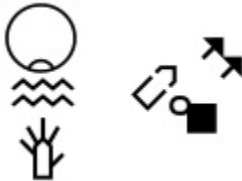
Spoken Word	SignWriting
ing	
ing	
Ingvild	
inherit	
inheritance	
injection	
injure	
injured	

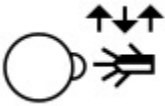





American Sign Language (ASL) Dictionary

Unedited 08082023

Spoken Word	SignWriting
injuries	
ink	
insane	
insane	
insect	
insect	
insert	
insert	



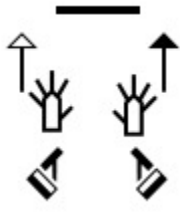

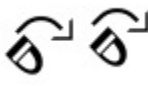
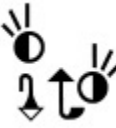



American Sign Language (ASL) Dictionary

Unedited 08082023

Spoken Word	SignWriting
inside-heart	
inside-mind	
insist	
insomnia	
inspiration	
inspire	
install	
instead	

American Sign Language (ASL) Dictionary

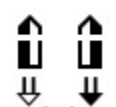
Unedited 08082023

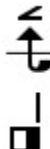
Spoken Word	SignWriting
instead	
institute	
institution	
instruction	
instruction	
instructor	 
instructor	 
insult	







American Sign Language (ASL) Dictionary

Unedited 08082023

Spoken Word	SignWriting
insult	<p>The SignWriting symbol for 'insult' consists of a vertical line with a hash symbol (#) at the top, a hand with fingers spread below it, and a small square at the bottom.</p>
insurance	<p>The SignWriting symbol for 'insurance' consists of a horizontal line on the left, a square on the right, and a hand with fingers spread below the square.</p>
insurance	<p>The SignWriting symbol for 'insurance' consists of a square on the right with a hand with fingers spread below it, and a vertical line with arrows pointing left and right on the left side.</p>
integrate	<p>The SignWriting symbol for 'integrate' consists of two curved arrows pointing down towards a central hand with fingers spread, with a vertical line and an asterisk (*) below the hand.</p>
intelligent	<p>The SignWriting symbol for 'intelligent' consists of a circle on the left with an asterisk (*) inside it, a hand with fingers spread to the right, and an arrow pointing up and to the right above the hand.</p>
intend	<p>The SignWriting symbol for 'intend' consists of a hand with fingers spread on the left, a square on the right, and a vertical line below the hand.</p>
intend	<p>The SignWriting symbol for 'intend' consists of a circle on the left with an asterisk (*) inside it, a hand with fingers spread to the right, and a vertical line below the hand.</p>

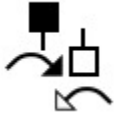





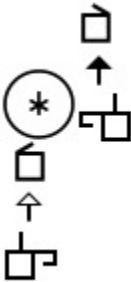

American Sign Language (ASL) Dictionary

Unedited 08082023

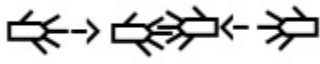
Spoken Word	SignWriting
intensity	
intentional-grounding	
interact	
interact	
intercourse	
interest	
interesting	
interesting	



American Sign Language (ASL) Dictionary

Unedited 08082023

Spoken Word	SignWriting
interesting	
interesting	
interface	
interfere	
internalize	
international	
international	
International SignWriting Alphabet	
international time	

American Sign Language (ASL) Dictionary

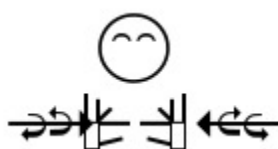
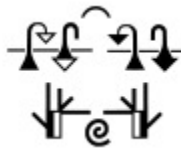
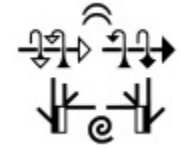
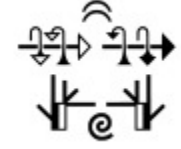
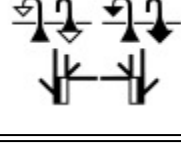
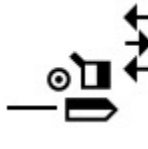
Unedited 08082023

Spoken Word	SignWriting
internet	
internet	
internet	
internet	
internet	
internet	
internship	
interpret	

American Sign Language (ASL) Dictionary

Unedited 08082023

Spoken Word	SignWriting
interpret	
interpret	
interpret	
interpret	
interpreter	
interpreter	
interpreter	







American Sign Language (ASL) Dictionary

Unedited 08082023

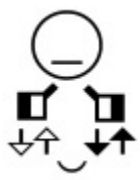
Spoken Word	SignWriting
interrogate	
interrupt	
interrupt	
interruption	
intersection	
intersection	
intersection	



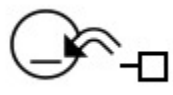
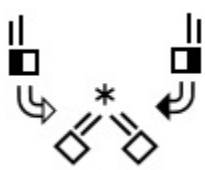



American Sign Language (ASL) Dictionary

Unedited 08082023

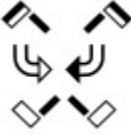
Spoken Word	SignWriting
intersex	
interview	
intestine	
intimate	
into	
intoxicated	
introduce	
introduce	
introduce	





American Sign Language (ASL) Dictionary

Unedited 08082023

Spoken Word	SignWriting
introduce	
introduction	
inuit	
invade	
invade	
invent	
invent	
invention	
inventor	

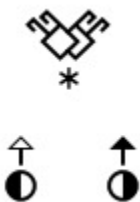
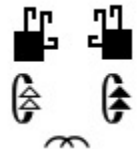
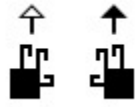







American Sign Language (ASL) Dictionary

Unedited 08082023

Spoken Word	SignWriting
invertebrate	
invest	
invest	
investigate	
invisible	
Invitation-Thanksgiving1	
Invitation-Thanksgiving2	
invite	
invite	



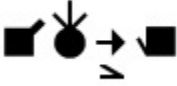

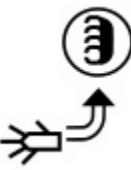

American Sign Language (ASL) Dictionary

Unedited 08082023

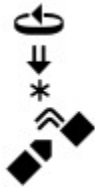
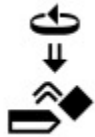
Spoken Word	SignWriting
invlove	
involve	
involve	
involve	
ion	
Iowa	
Iowa	
Iowa	
irate	

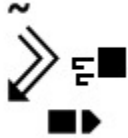

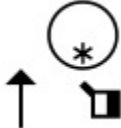



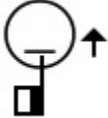
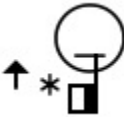

American Sign Language (ASL) Dictionary

Unedited 08082023

Spoken Word	SignWriting
Ireland	
Ireland	
Ireland	
Irish	
irish	
iron	
is	
is	

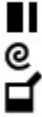





American Sign Language (ASL) Dictionary

Unedited 08082023

Spoken Word	SignWriting
is	
is	
is	
is that true?	
island	
island	
island	
isotonic	
Israel	

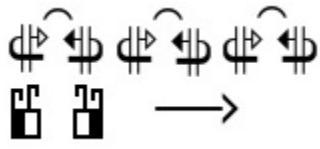
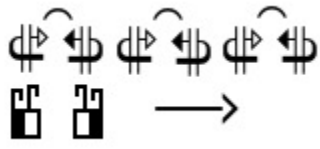





American Sign Language (ASL) Dictionary

Unedited 08082023

Spoken Word	SignWriting
Israel	
Israel	
issue	
issues	
issues	
it	
it	
it's	
Italian	





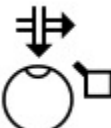

American Sign Language (ASL) Dictionary

Unedited 08082023

Spoken Word	SignWriting
Italian	
Italian	
Italian	
Italy	
Italy	
Italy	
Italy	
Italy	

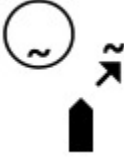
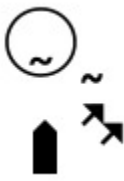



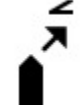



American Sign Language (ASL) Dictionary

Unedited 08082023

Spoken Word	SignWriting
itch	
item	
its	
its	
its	
its	
its	
its	
its	

American Sign Language (ASL) Dictionary

Unedited 08082023

Spoken Word	SignWriting
Ivo	
J	
J - left hand	
J - expressive - right hand	
J - fingerspelling - expressive - left hand	
J.J.	
Jacalyn's Name Sign	
Jacalyn's Name Sign	
jack	





American Sign Language (ASL) Dictionary

Unedited 08082023

Spoken Word	SignWriting
jacket	<p>The SignWriting symbol for 'jacket' consists of a horizontal line at the top. Below it are two diamond shapes, each with an asterisk to its left and right. Underneath the diamonds are two curved arrows pointing towards each other, with a small circle between them.</p>
Jackhammer	<p>The SignWriting symbol for 'Jackhammer' is a vertical sequence of symbols. From top to bottom: a hand with fingers spread, a hammer head, a hammer handle, a hand holding a tool, a hand holding a tool, a hand holding a tool, a hand holding a tool, a hand holding a tool, and a hand holding a tool.</p>
Jackhammer	<p>The SignWriting symbol for 'Jackhammer' features a circle with a hand inside at the top. Below it are two sets of arrows pointing up and down, with two small squares below each set.</p>
jail	<p>The SignWriting symbol for 'jail' shows two diamond shapes with asterisks, connected by a vertical line. Below the line are two more diamond shapes with asterisks.</p>
jail	<p>The SignWriting symbol for 'jail' depicts a hand with fingers spread, a diamond shape with an asterisk, and an upward-pointing arrow.</p>
jail 2	<p>The SignWriting symbol for 'jail 2' consists of a circle at the top, with two diamond shapes below it, each with a tilde symbol (~) underneath.</p>



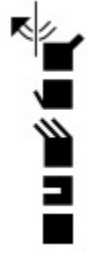
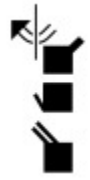







American Sign Language (ASL) Dictionary

Unedited 08082023

Spoken Word	SignWriting
jailed	
jailed	
jam	
James	
Jan	
Jan	







American Sign Language (ASL) Dictionary

Unedited 08082023

Spoken Word	SignWriting
janitor	
January	
January	
January	
January	
Japan	
Japan	
Japan	
Japan	
Japanese	
Japanese	

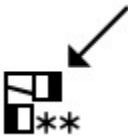
American Sign Language (ASL) Dictionary

Unedited 08082023

Spoken Word	SignWriting
Japanese	
jar	
jargon	
Jason	
Jason	
Jason Nesmith	
jaw dropping with surprise	





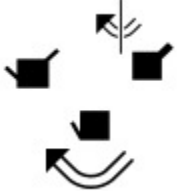
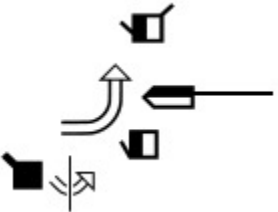
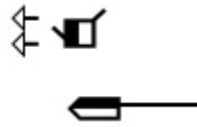
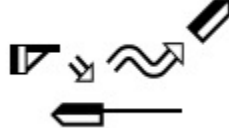
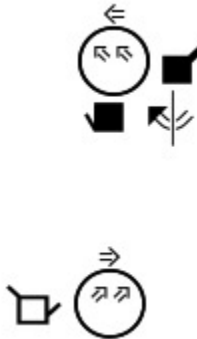
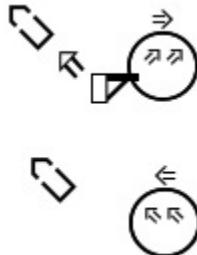

American Sign Language (ASL) Dictionary

Unedited 08082023

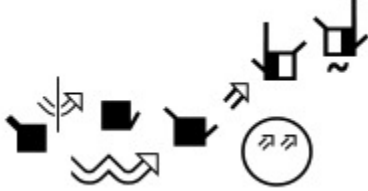
Spoken Word	SignWriting
Jay	
Jay	
Jay	
Jay	
Jay	
Jay	

American Sign Language (ASL) Dictionary

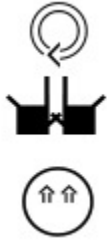
Unedited 08082023

Spoken Word	SignWriting
Jay	
Jay	
Jay	
Jay	
Jay	
Jay	



American Sign Language (ASL) Dictionary

Unedited 08082023

Spoken Word	SignWriting
Jay	<p>The SignWriting for 'Jay' consists of two parts. The first part shows a hand sign with a tilde (~) above it, followed by a downward arrow and a circle containing two downward arrows (⇓). The second part shows a downward arrow, a circle containing two downward arrows (⇓), and a hand sign with a horizontal line above it, followed by an asterisk (*).</p>
Jay	<p>The SignWriting for 'Jay' consists of three parts: two house-like symbols (two vertical lines with a pointed top), two house-like symbols with vertical lines extending downwards, and a circle containing two house-like symbols with a horizontal line below it.</p>
Jay	<p>The SignWriting for 'Jay' consists of a hand sign with a double arrow pointing up and to the right, a hand sign with a curved arrow pointing down and to the right, a hand sign with a curved arrow pointing down and to the left, a hand sign with a curved arrow pointing up and to the left, and a circle containing two crossed arrows (↯).</p>
jealous	<p>The SignWriting for 'jealous' consists of a sad face with a downward-curving mouth and a hand sign with a vertical line and a horizontal line.</p>
jealous	<p>The SignWriting for 'jealous' consists of a circle with a horizontal line through it and a hand sign with a vertical line and a horizontal line.</p>



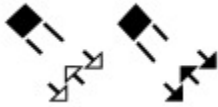
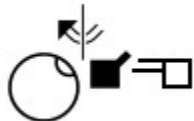

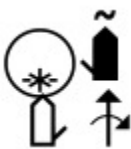
American Sign Language (ASL) Dictionary

Unedited 08082023

Spoken Word	SignWriting
jeans	
jeer	
Jehovah	
jellyfish	
jellyfish	
Jeremiah 17:9	
Jerusalem	

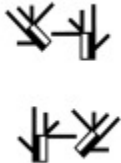

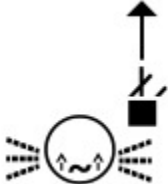
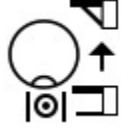

American Sign Language (ASL) Dictionary

Unedited 08082023

Spoken Word	SignWriting
Jesus Christ	
Jesus Christ	
Jesus Christ	
jet fighter	
Jew	
Jew	

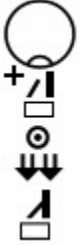

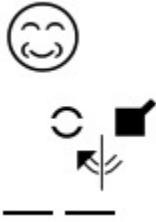

American Sign Language (ASL) Dictionary

Unedited 08082023

Spoken Word	SignWriting
Jew	
jeweler	
jewelry	
Joachim	
job	
job	





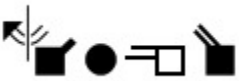

American Sign Language (ASL) Dictionary

Unedited 08082023

Spoken Word	SignWriting
job	
jockey	
John	
John	
John	

American Sign Language (ASL) Dictionary

Unedited 08082023

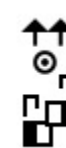
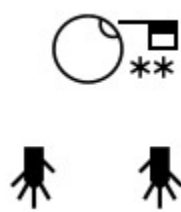
Spoken Word	SignWriting
Johnny	
Johnny	
join	
join	
join-rid	
join-ride	
joke	
jolt	







American Sign Language (ASL) Dictionary

Unedited 08082023

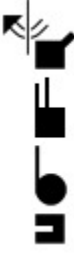
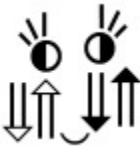
Spoken Word	SignWriting
jostle	<p>The SignWriting for 'jostle' consists of a horizontal line with two squares on it. Below the line are three sets of arrows: a downward arrow, an upward arrow, and a downward arrow; an upward arrow, a downward arrow, and an upward arrow; and a downward arrow.</p>
journalist	<p>The SignWriting for 'journalist' features a hand holding a pen writing on a notepad, with an eye icon above it. Below this are two vertical bars with upward arrows, and a downward arrow between them.</p>
joy	<p>The SignWriting for 'joy' includes a circle with a downward arrow inside, a hand holding a pen writing on a notepad, and a vertical bar with a downward arrow.</p>
Juda	<p>The SignWriting for 'Juda' shows a hand holding a pen writing on a notepad, a vertical bar with a downward arrow, and a circle with a downward arrow.</p>
Judah	<p>The SignWriting for 'Judah' includes a hand holding a pen writing on a notepad, a vertical bar with a downward arrow, a circle with a downward arrow, and a hand holding a pen writing on a notepad.</p>



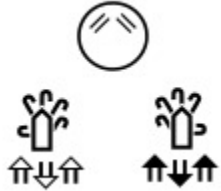



American Sign Language (ASL) Dictionary

Unedited 08082023

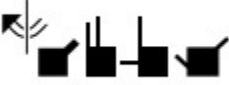
Spoken Word	SignWriting
Jude	
judge	
judge	
judge - person	
judgement	
juggle	
juice	



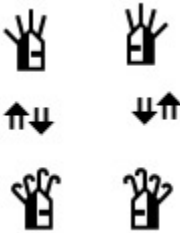



American Sign Language (ASL) Dictionary

Unedited 08082023

Spoken Word	SignWriting
July	
jump	
jump	
jump	
jump	
jumping for joy	
junction	
June	



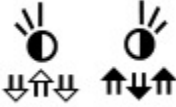

American Sign Language (ASL) Dictionary

Unedited 08082023

Spoken Word	SignWriting
Junior	
junior	
junior	
junk	
jupiter	
just	
just	
just - equitable	



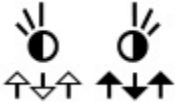
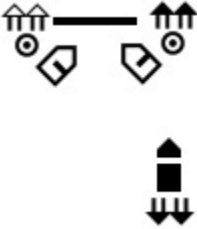







American Sign Language (ASL) Dictionary

Unedited 08082023

Spoken Word	SignWriting
just a minute	
just married	
justice	
juvenile	
K	







American Sign Language (ASL) Dictionary

Unedited 08082023

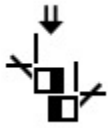
Spoken Word	SignWriting
K	
K	
K - receptive	
Kaddish	
kangaroo	
Kansas	
Kansas	
Kansas City	
Kansas City	
karate	
kayak	

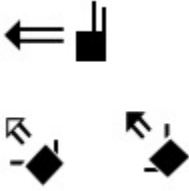

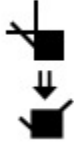
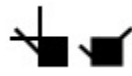





American Sign Language (ASL) Dictionary

Unedited 08082023

Spoken Word	SignWriting
keep	
keep in mind	
keep right	
keeping fingers crossed	
Kelly Jo	
Kentucky	
Kentucky	
ketchup	
ketchup	







American Sign Language (ASL) Dictionary

Unedited 08082023

Spoken Word	SignWriting
ketchup	
ketchup	
Kevin Clark	
Kevin Clark	
Kevin Clark	
Kevin Clark	
key	
key	

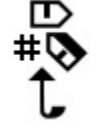

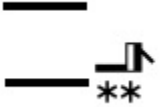



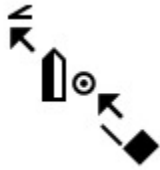

American Sign Language (ASL) Dictionary

Unedited 08082023

Spoken Word	SignWriting
keyhole	
kick	
kick	
kick	
kickball	
kid	
kidney	
kill	

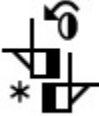



American Sign Language (ASL) Dictionary

Unedited 08082023

Spoken Word	SignWriting
kill	
kill	
kill	
Kim S.	
kind of	
kind of	
kindness	
kindness	
king	

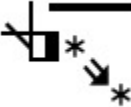

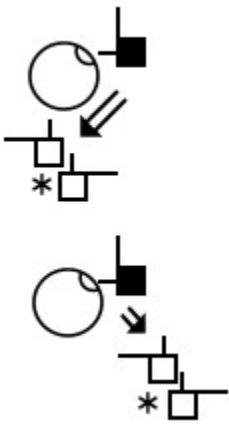

American Sign Language (ASL) Dictionary

Unedited 08082023

Spoken Word	SignWriting
king	
king	
king	
kingdom	
kinsmen	

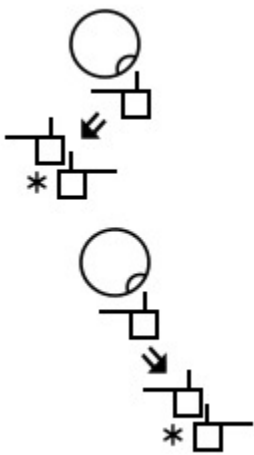
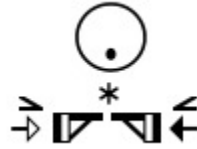





American Sign Language (ASL) Dictionary

Unedited 08082023

Spoken Word	SignWriting
kinswomen	
kiss	
kiss someone lying down	
kissfist	
kissfist	
kitchen	





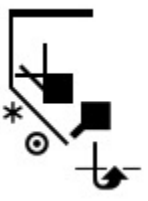

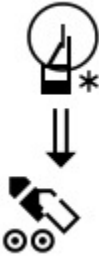

American Sign Language (ASL) Dictionary

Unedited 08082023

Spoken Word	SignWriting
kitchen	
kitchen	
kitchen	
kitchen	
kite	
kite	
KJNameSign	

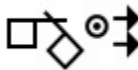







American Sign Language (ASL) Dictionary

Unedited 08082023

Spoken Word	SignWriting
kleenex	
kneel	
kneel down	
knife	
knife	
knife	
knight	
knight	
knitting	





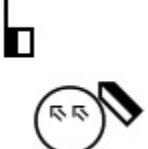

American Sign Language (ASL) Dictionary

Unedited 08082023

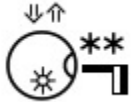
Spoken Word	SignWriting
knock	
knock repeatedly	
knock softly	
know	
know	
Know	
Know	
know	
know	



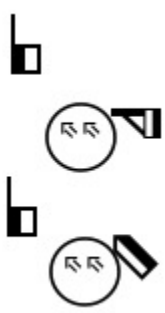
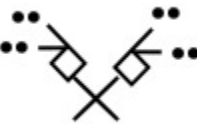





American Sign Language (ASL) Dictionary

Unedited 08082023

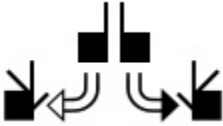
Spoken Word	SignWriting
know - sympathetically	
know eyebrows up	
know that	
know that	
know-that	
koala	
Korea	
Korean	



American Sign Language (ASL) Dictionary

Unedited 08082023

Spoken Word	SignWriting
kosher	
kumari	
Kwanzaa	
L	
L - receptive	
La Jolla, California	 
La Jolla, California	
label	

American Sign Language (ASL) Dictionary

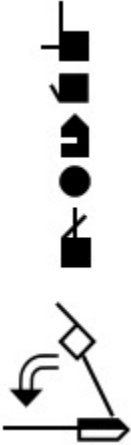
Unedited 08082023

Spoken Word	SignWriting
<p style="text-align: center;">Labor Day</p>	
<p style="text-align: center;">lady</p>	
<p style="text-align: center;">lady - left</p>	





American Sign Language (ASL) Dictionary

Unedited 08082023

Spoken Word	SignWriting
lady-left	<p>The SignWriting for 'lady-left' consists of several components: a large circle at the top right, a small square with a vertical line, a hand with fingers spread, a hand with fingers spread and a small circle, and a hand with fingers spread and a small circle.</p>
ladybug	<p>The SignWriting for 'ladybug' includes a large circle with an asterisk, a small square with a vertical line, a hand with fingers spread and an asterisk, and a hand with fingers spread and an asterisk.</p>
laid off	<p>The SignWriting for 'laid off' features a large circle with a tilde (~), a small square with a vertical line, and a hand with fingers spread and an arrow pointing up and to the right.</p>
laid-up	<p>The SignWriting for 'laid-up' shows a large circle with a tilde and a small circle inside, a hand with fingers spread and a small circle, and a hand with fingers spread and a small circle.</p>
lake	<p>The SignWriting for 'lake' includes a large circle, a hand with fingers spread and a small circle, and a hand with fingers spread and a small circle.</p>

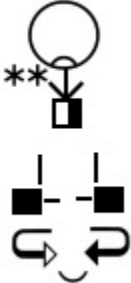
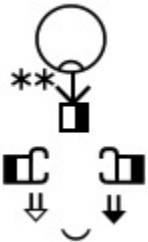

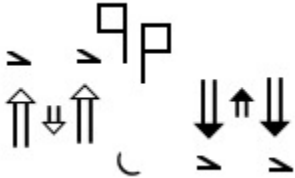

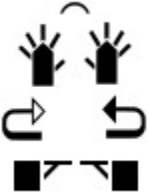

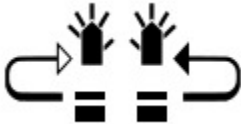

American Sign Language (ASL) Dictionary

Unedited 08082023

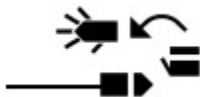
Spoken Word	SignWriting
lake	
lake	
lamb	
lamb	
lame	
lamp	
land	



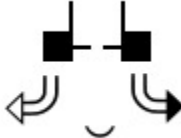



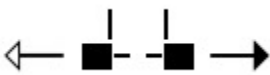

American Sign Language (ASL) Dictionary

Unedited 08082023

Spoken Word	SignWriting
land	
land	
land	
land	
landslide	
landslide-score	
language	
language	
language	

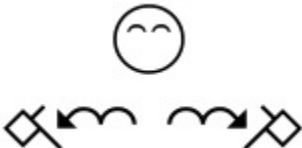
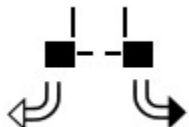





American Sign Language (ASL) Dictionary

Unedited 08082023

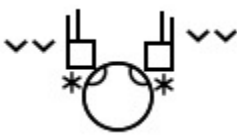
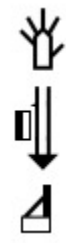
Spoken Word	SignWriting
language	
language	
language	
language	
language	
language	
language	
language	
lantern	





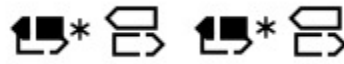

American Sign Language (ASL) Dictionary

Unedited 08082023

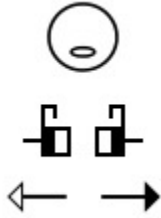
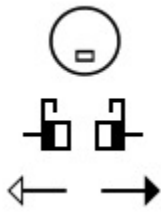
Spoken Word	SignWriting
lapin	
lapse	
laptop	
laptop	
laptop-computer	
laptop-computer	
laptop-computer	
laptop-computer	

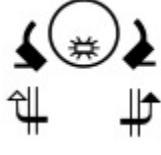



American Sign Language (ASL) Dictionary

Unedited 08082023

Spoken Word	SignWriting
large	
large	
large	
large	
large curved ears	
large curved mass	
large font	
large pointy animal ears	



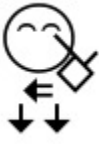
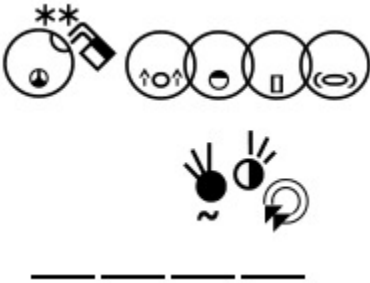
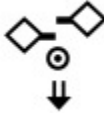
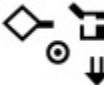

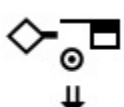
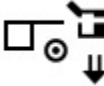

American Sign Language (ASL) Dictionary

Unedited 08082023

Spoken Word	SignWriting
larynx	
Las Vegas	
LASIK	
Lasse	
last	
last	
last	
last	
last	

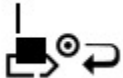

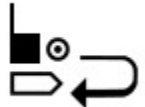
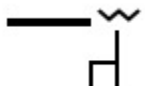
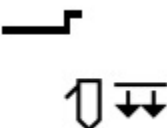
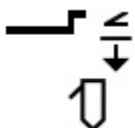





American Sign Language (ASL) Dictionary

Unedited 08082023

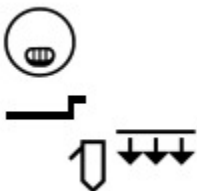
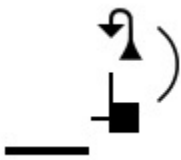
Spoken Word	SignWriting
last	
last	
last week	
last week	
last week	
last week	
last year	
late	
late	
late	





American Sign Language (ASL) Dictionary

Unedited 08082023

Spoken Word	SignWriting
late at night	
late morning	
late repeatedly	
later	
later	
later	
later	
later	
later on	



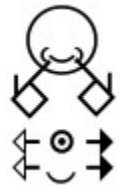

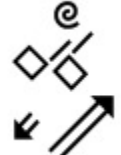



American Sign Language (ASL) Dictionary

Unedited 08082023

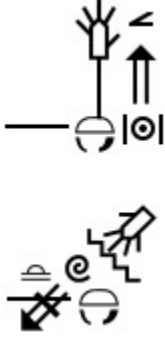
Spoken Word	SignWriting
later-on	
Latin America	
laugh	
laugh	
laughter	
launch	
launch-rocket	









American Sign Language (ASL) Dictionary

Unedited 08082023

Spoken Word	SignWriting
laundry	
Laurent Clerc	
lava	
law	
law	
law	
law enforcement	
lawyer	

American Sign Language (ASL) Dictionary

Unedited 08082023

Spoken Word	SignWriting
lawyer	
lawyer	
lay	
lay (an egg)	
lay-aside	
lay-down	
Laying	
lazy	







American Sign Language (ASL) Dictionary

Unedited 08082023

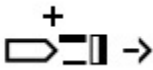
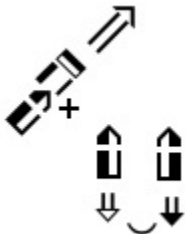
Spoken Word	SignWriting
lazy	<p>The SignWriting symbol for 'lazy' consists of a horizontal line above a diamond shape with a vertical line through its center. Below the diamond are two asterisks (**).</p>
lead	<p>The SignWriting symbol for 'lead' (upward) features a diagonal line with an arrowhead pointing up and to the right. A plus sign (+) is positioned below the line.</p>
lead	<p>The SignWriting symbol for 'lead' (downward) features a diagonal line with an arrowhead pointing down and to the left. A plus sign (+) is positioned below the line.</p>

American Sign Language (ASL) Dictionary

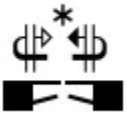
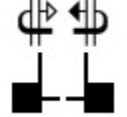
Unedited 08082023

Spoken Word	SignWriting
lead	
leader	
leaf	
leaf	
leaf	
league	
league	
leak	







American Sign Language (ASL) Dictionary

Unedited 08082023

Spoken Word	SignWriting
lean	<p>The SignWriting for 'lean' consists of three main components: a circle with two inward-pointing triangles (representing the mouth), a diamond with an asterisk, and a vertical double-headed arrow with a curved arrow on the right side pointing downwards.</p>
leap	<p>The SignWriting for 'leap' consists of a vertical sequence of symbols: a square with a small square inside, an upward-pointing arrow, another square with a small square inside, and a downward-pointing arrow with an asterisk below it.</p>
learn	<p>The SignWriting for 'learn' consists of a circle with a smiling face, a diamond with an asterisk, a hand with fingers spread, and a square with a small square inside.</p>
learn	<p>The SignWriting for 'learn' consists of a circle with a smiling face, a diamond with an asterisk, an upward-pointing arrow, a hand with fingers spread, and a square with a small square inside.</p>
learn	<p>The SignWriting for 'learn' consists of a circle with a smiling face, a diamond with an asterisk, an upward-pointing arrow, a hand with fingers spread, and a square with a small square inside.</p>
learn	<p>The SignWriting for 'learn' consists of a diamond with an asterisk, an upward-pointing arrow, a hand with fingers spread, and a square with a small square inside.</p>

American Sign Language (ASL) Dictionary

Unedited 08082023

Spoken Word	SignWriting
learn	
learn	
learn	
learn	
learn	
learn	
learn	







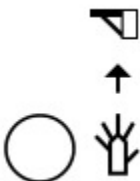

American Sign Language (ASL) Dictionary

Unedited 08082023

Spoken Word	SignWriting
learn	
learn	
learn	
Learn SignWriting	
learning	
leave	





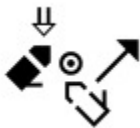

American Sign Language (ASL) Dictionary

Unedited 08082023

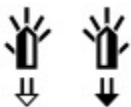
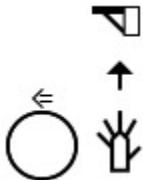
Spoken Word	SignWriting
leave	
leave	
leave	
leave	
leave	
leave	
leave	
leave	
leave	

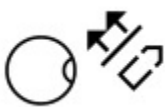

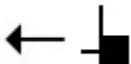
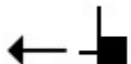



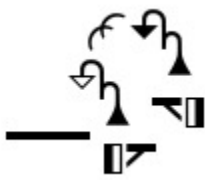

American Sign Language (ASL) Dictionary

Unedited 08082023

Spoken Word	SignWriting
leave	
leave headnod on left	
lecture	
lecture	
Lee	
left	
left	
left flip	
leg	

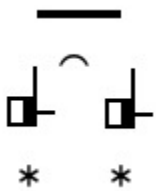



American Sign Language (ASL) Dictionary

Unedited 08082023

Spoken Word	SignWriting
legacy	
legal	
legal	
legal	
Legislative	
Leia	
lemon	
lemon	

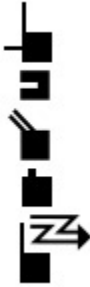

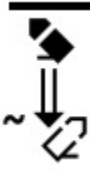



American Sign Language (ASL) Dictionary

Unedited 08082023

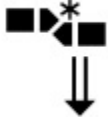
Spoken Word	SignWriting
lemon	
Lentz	
leotard	
lesbian	
less	
less than	

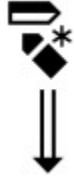
American Sign Language (ASL) Dictionary

Unedited 08082023

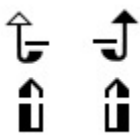
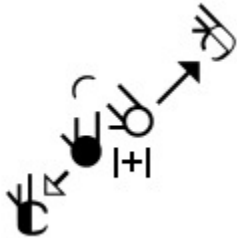
Spoken Word	SignWriting
less-than	
less-than	
less-than	
lesson	
lesson	
lessons	
lessons	
let	
let-it-go	















American Sign Language (ASL) Dictionary

Unedited 08082023

Spoken Word	SignWriting
letter	<p>The SignWriting symbol for 'letter' consists of a circle at the top containing a downward-pointing arrow. Below this is a square with an asterisk to its upper-left. A downward arrow points from the square to another square with an asterisk to its upper-left. A final downward arrow points from this square to a diamond shape.</p>
letter (abc)	<p>The SignWriting symbol for 'letter (abc)' features a square at the bottom with an upward-pointing arrow. Above the square is a horizontal line with two upward-pointing arrows. To the right of this line is a vertical arrow pointing upwards.</p>
letter (abc)	<p>The SignWriting symbol for 'letter (abc)' is a vertical sequence of shapes: a horizontal line at the top, followed by a square, a horizontal line, a square, a horizontal line, a square, a horizontal line, a square, and a horizontal line at the bottom.</p>
letter (abc)	<p>The SignWriting symbol for 'letter (abc)' is a horizontal sequence of shapes: a horizontal line at the top, followed by a square, a horizontal line, a square, a horizontal line, a square, a horizontal line, a square, and a horizontal line at the bottom.</p>
letter (abc)	<p>The SignWriting symbol for 'letter (abc)' consists of a square at the bottom with an upward-pointing arrow. Above the square is a horizontal line with two asterisks to its upper-left.</p>
letter A	<p>The SignWriting symbol for 'letter A' is a square with a downward-pointing arrow.</p>
letter B	<p>The SignWriting symbol for 'letter B' is a square with a downward-pointing arrow.</p>
letter C	<p>The SignWriting symbol for 'letter C' is a circle with a downward-pointing arrow.</p>
letter D	<p>The SignWriting symbol for 'letter D' is a circle with a downward-pointing arrow.</p>
letter E	<p>The SignWriting symbol for 'letter E' is a square with a downward-pointing arrow.</p>









American Sign Language (ASL) Dictionary

Unedited 08082023

Spoken Word	SignWriting
letter F	
letter G	
letter H	
letter i	
letter J	
letter K	
letter L	
letter M	
letter N	
letter O	
letter P	
letter Q	
letter R	
letter S	





American Sign Language (ASL) Dictionary

Unedited 08082023

Spoken Word	SignWriting
letter T	
letter U	
letter V	
letter W	
letter X	
letter Y	
letter Z	
letter Z	





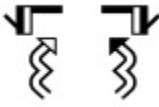
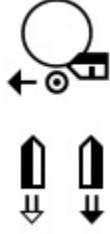
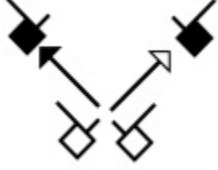
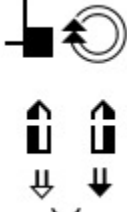



American Sign Language (ASL) Dictionary

Unedited 08082023

Spoken Word	SignWriting
letter-2	
lettuce	
lettuce	
lettuce	
levels	
liar	
liberty	
librarian	

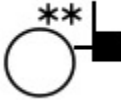
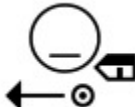
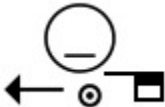

American Sign Language (ASL) Dictionary

Unedited 08082023

Spoken Word	SignWriting
library	
library	
license	
lick	
Licoln	
lie	
lie	
lie	
lie-down	
life	



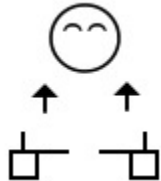

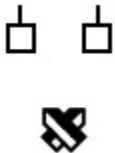
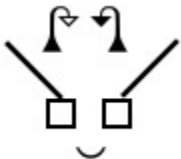
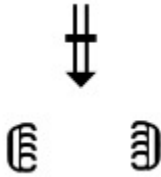
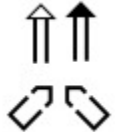
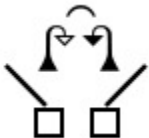

American Sign Language (ASL) Dictionary

Unedited 08082023

Spoken Word	SignWriting
life	
life jacke	
lifeguard	
lift	
lift-to-face	
lift-up	
lifting	

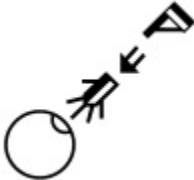

American Sign Language (ASL) Dictionary

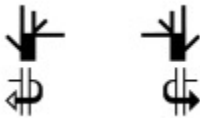
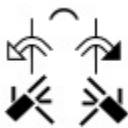
Unedited 08082023

Spoken Word	SignWriting
light	
light	
light	
light	
light	
light (electric)	
light (weight)	
light color	



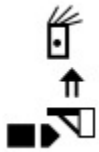
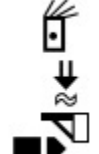
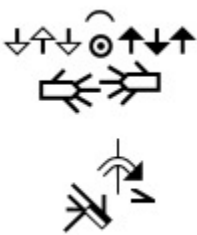

American Sign Language (ASL) Dictionary

Unedited 08082023

Spoken Word	SignWriting
light comes on	
light from sunrise	
light from sunset	
light grey	
light pink	
light shining down	

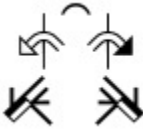
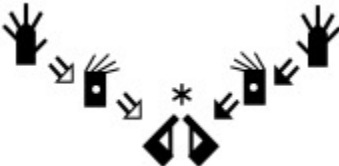
American Sign Language (ASL) Dictionary

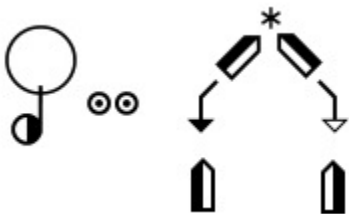
Unedited 08082023

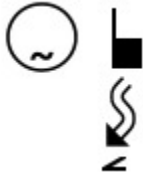
Spoken Word	SignWriting
light weight	
light-fades	
lightening	
Lighthouse	
lightning	
lightning	
lightning	

American Sign Language (ASL) Dictionary

Unedited 08082023

Spoken Word	SignWriting
lightsaber	
like	
like	
like	
like	
Like	





American Sign Language (ASL) Dictionary

Unedited 08082023

Spoken Word	SignWriting
like-2	
lime	
limit	
limit	
limousine	
Lincoln	
line	



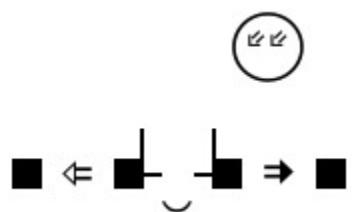
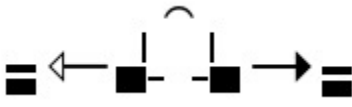

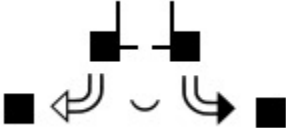
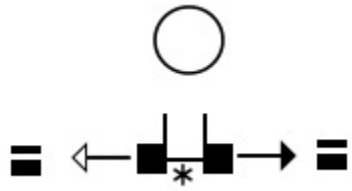
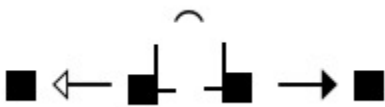

American Sign Language (ASL) Dictionary

Unedited 08082023

Spoken Word	SignWriting
line	
line (of people)	
linguistics	
linguistics	
linguistics	
linguistics	
linguistics	
linguistics	

American Sign Language (ASL) Dictionary

Unedited 08082023

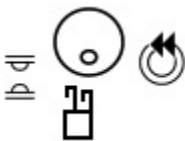
Spoken Word	SignWriting
link	
link	
linking	
lion	
lion	
lip read	
Lipread	
lips	





American Sign Language (ASL) Dictionary

Unedited 08082023

Spoken Word	SignWriting
lips floping over teeth	<p>The signwriting consists of a circle with a horizontal bar inside, representing a mouth. Below it are three vertical arrows: up, down, up. This is followed by two horizontal arrows pointing right, one above the other, representing the lips. Below these are two more vertical arrows: up, down, up.</p>
liquid	<p>The signwriting starts with a vertical bar and a plus sign, + . Below this is a hand icon with fingers spread. At the bottom are two circular arrows, one on the left and one on the right, representing liquid.</p>
liquid	<p>The signwriting features a vertical bar, a square, and a hand icon with fingers spread. Below these are two asterisks, **.</p>
liquid	<p>The signwriting includes a hand icon with fingers spread, a vertical bar and plus sign, + , two horizontal arrows pointing right, and a wavy line at the bottom representing liquid.</p>
liquid	<p>The signwriting shows a hand icon with fingers spread, a vertical bar and plus sign, + , and a wavy line representing liquid.</p>
liquid	<p>The signwriting features a vertical bar and plus sign, + , a hand icon with fingers spread, and a wavy line representing liquid.</p>

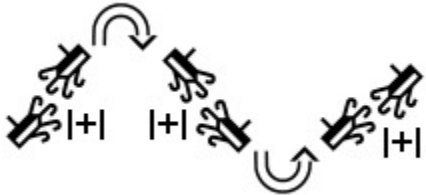

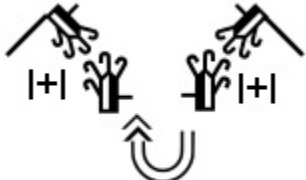
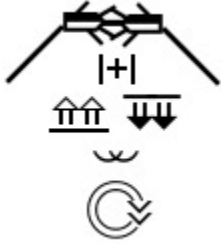
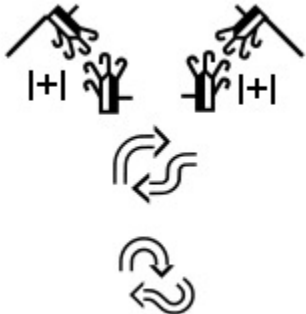



American Sign Language (ASL) Dictionary

Unedited 08082023

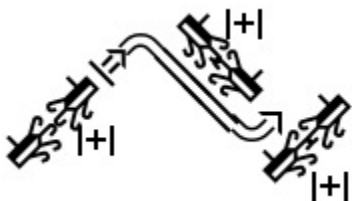
Spoken Word	SignWriting
liquid	
liquid	
liquid	
liquid	
liquid	
liquid	



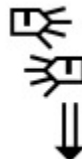

American Sign Language (ASL) Dictionary

Unedited 08082023

Spoken Word	SignWriting
liquid	
liquor	
liquor	
liquor	
list	
list	
list	
list	





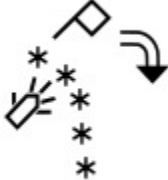

American Sign Language (ASL) Dictionary

Unedited 08082023

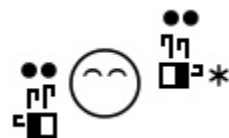
Spoken Word	SignWriting
list	
list	
list of five things	
list of five things with emphasis	
list-things	



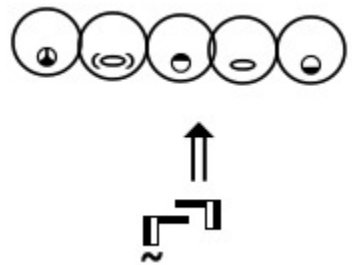

American Sign Language (ASL) Dictionary

Unedited 08082023

Spoken Word	SignWriting
listen	
listen	
listen	
listen	
listen	
Listen	
listening	
Liter	

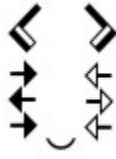
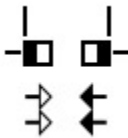

American Sign Language (ASL) Dictionary

Unedited 08082023

Spoken Word	SignWriting
literacy	
literate	
literature	
literature	
little	
little	



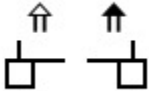
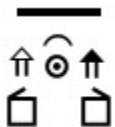
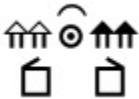
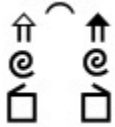
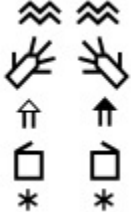
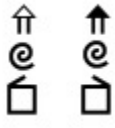

American Sign Language (ASL) Dictionary

Unedited 08082023

Spoken Word	SignWriting
little	
little	
little-bit	
live	
live	
live	
live	
live	
live	

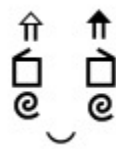
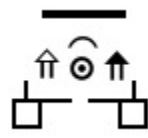

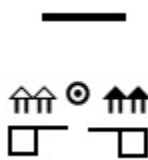

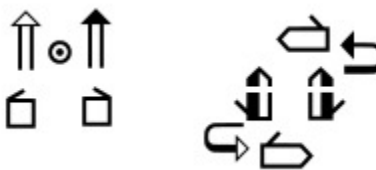
American Sign Language (ASL) Dictionary

Unedited 08082023

Spoken Word	SignWriting
live	
live	
living	
living	
living room	
living room	
living room	

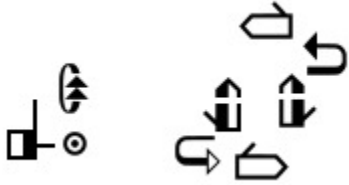
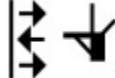



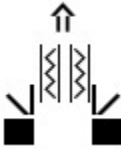

American Sign Language (ASL) Dictionary

Unedited 08082023

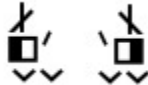
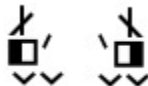
Spoken Word	SignWriting
living-room	
llama	
lllllll	
loading zone	
loan officer	
lobster	

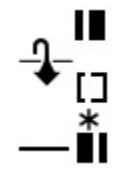

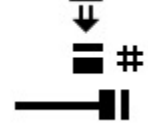



American Sign Language (ASL) Dictionary

Unedited 08082023

Spoken Word	SignWriting
lobster	
lobster	
lobster	
lobster	
lock	
lock	
Lock	
locker	



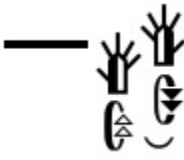
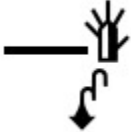

American Sign Language (ASL) Dictionary

Unedited 08082023

Spoken Word	SignWriting
lollipop	
lonely	
lonesome	
long	
long bangs	
long bangs	
long before	
long before	

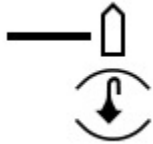
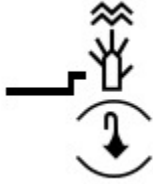

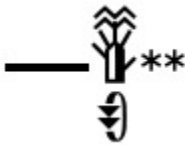
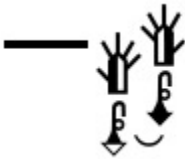

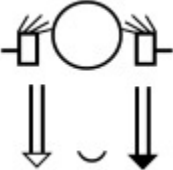



American Sign Language (ASL) Dictionary

Unedited 08082023

Spoken Word	SignWriting
long before	
long before	
long before	
long before	
long before	
long ears blowing back	
long sleeve	
long straight hair	

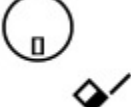





American Sign Language (ASL) Dictionary

Unedited 08082023

Spoken Word	SignWriting
long time ago	
longer	
look	
look	
look	
look	
look	
look	
look at	

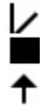



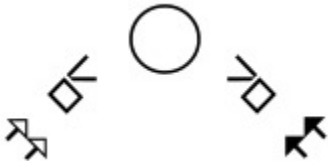

American Sign Language (ASL) Dictionary

Unedited 08082023

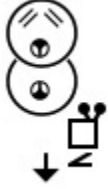
Spoken Word	SignWriting
look at	
look at	
look at	
look at	
look at	
look at	
look at each other	
look at me	

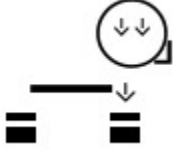



American Sign Language (ASL) Dictionary

Unedited 08082023

Spoken Word	SignWriting
look at me	
look at wrist	
look away	
look down on motorcycle	
look like	
look like	
look upward	

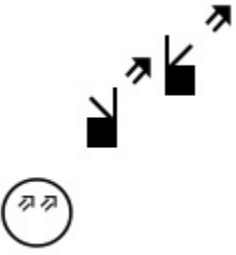
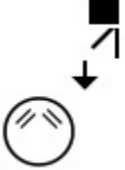

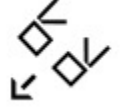
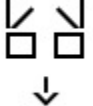

American Sign Language (ASL) Dictionary

Unedited 08082023

Spoken Word	SignWriting
look-above-right	
look-at-me	
look-at-me	
look-at-me-from-left	
look-at-me-from-right	
look-at-me-you	
look-down	

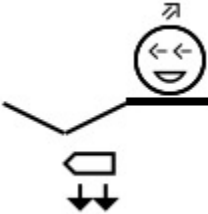
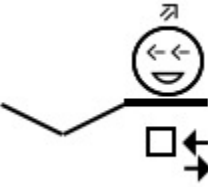
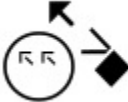

American Sign Language (ASL) Dictionary

Unedited 08082023

Spoken Word	SignWriting
look-down	
look-for	
look-forward-to	
look-left	
look-left	
look-left	
look-left	







American Sign Language (ASL) Dictionary

Unedited 08082023

Spoken Word	SignWriting
look-over	
look-right-left	



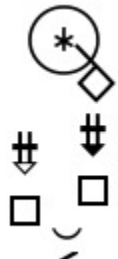

American Sign Language (ASL) Dictionary

Unedited 08082023

Spoken Word	SignWriting
look-sad	
look-smile	
look-smile	
look-strong	
look-strong	
look-up	
look-up-right-palms	

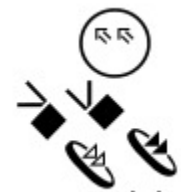
American Sign Language (ASL) Dictionary

Unedited 08082023

Spoken Word	SignWriting
look-up-to	
look-up-to	
looking at me	
looking at vehicle coming up on left	
looking up right, left, right	
looking up right, left, right, traveling up	







American Sign Language (ASL) Dictionary

Unedited 08082023

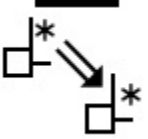
Spoken Word	SignWriting
looks-like	<p>The signwriting consists of a circle containing a stylized eye with a curved line above it, followed by a diamond shape, a square, and two vertical arrows pointing downwards.</p>
lookup	<p>The signwriting consists of a circle containing a stylized eye, followed by a square and a diamond shape.</p>
loose gravel	<p>The signwriting consists of a diamond shape with a vertical line through it, followed by two asterisks, and then two diamond shapes with zigzag lines inside, each with an arrow pointing outwards.</p>
Lord	<p>The signwriting consists of a diamond shape with a vertical line through it, followed by an asterisk, a diamond shape with a vertical line through it, and a diamond shape with a diagonal line through it.</p>
Lord	<p>The signwriting consists of a horizontal line, a diamond shape with a vertical line through it, an asterisk, a diamond shape with a diagonal line through it, and another diamond shape with a vertical line through it.</p>
Lord	<p>The signwriting consists of a horizontal line, a diamond shape with a vertical line through it, an asterisk, a diamond shape with a diagonal line through it, and another diamond shape with a vertical line through it.</p>
Lord	<p>The signwriting consists of a diamond shape with a vertical line through it, an asterisk, a diamond shape with a diagonal line through it, and another diamond shape with a vertical line through it.</p>

American Sign Language (ASL) Dictionary

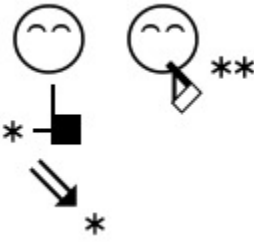
Unedited 08082023

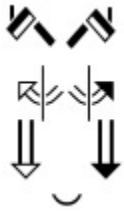
Spoken Word	SignWriting
Lord	
lord	
lord (2)	
lord (3)	
lords-supper	
Los Angeles	
Los Angeles	
lose	

American Sign Language (ASL) Dictionary

Unedited 08082023

Spoken Word	SignWriting
lose	
lose	
lose	
lose	
lose	
lose	
lose	





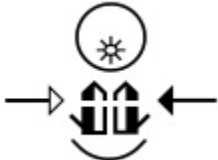
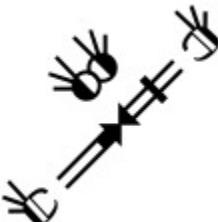
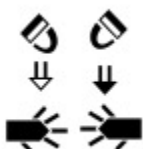
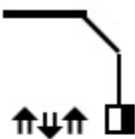
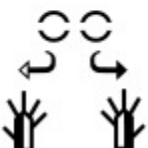
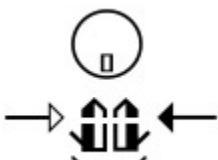

American Sign Language (ASL) Dictionary

Unedited 08082023

Spoken Word	SignWriting
lose	
lose weight	
lost	
lost	
lost luggage	 
lost weight	

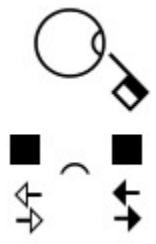
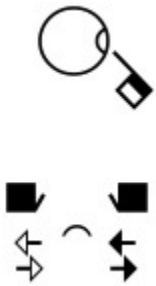





American Sign Language (ASL) Dictionary

Unedited 08082023

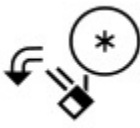
Spoken Word	SignWriting
lotion	
lots	
loud	
loud	
Louisiana	
Louisiana	
Louisiana	
Louisiana	









American Sign Language (ASL) Dictionary

Unedited 08082023

Spoken Word	SignWriting
lousy	
lousy	
lousy	
lousy	
love	
love	
love	
love	



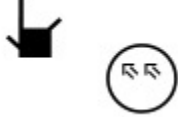

American Sign Language (ASL) Dictionary

Unedited 08082023

Spoken Word	SignWriting
love	
love	
love	
love something	
love-it	
love-something	
love-something	
love-you	
lovely	

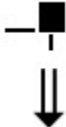
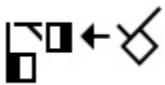



American Sign Language (ASL) Dictionary

Unedited 08082023

Spoken Word	SignWriting
lovely	
low	
low battery	
LT	
Lucifer	
Lucinda-Batch	
Lucinda-O-'Grady-Batch	

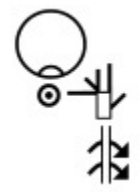



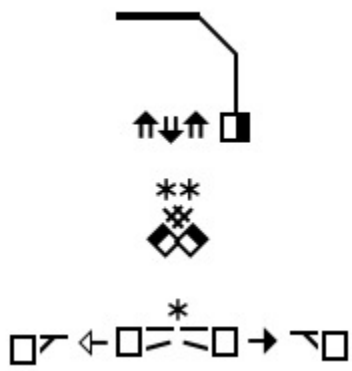
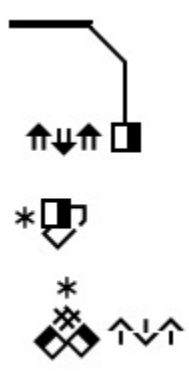

American Sign Language (ASL) Dictionary

Unedited 08082023

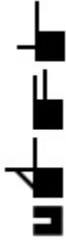
Spoken Word	SignWriting
lucky	
lucky	
Lucy-Dlugolecka	
luggage	
luggage tag	
luggage weigh in	

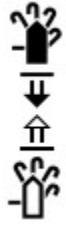





American Sign Language (ASL) Dictionary

Unedited 08082023

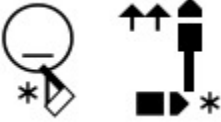
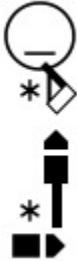
Spoken Word	SignWriting
Luke	
luminous	
lump sum	
Lumturi	
lunch	
lunch	

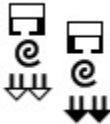

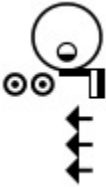

American Sign Language (ASL) Dictionary

Unedited 08082023

Spoken Word	SignWriting
lunch	
lunch	
lungs	
lust	
lust	
lying	
M	
M	

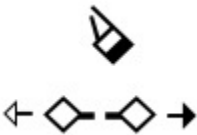
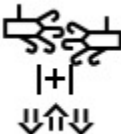

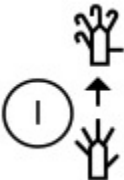



American Sign Language (ASL) Dictionary

Unedited 08082023

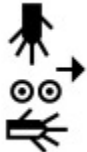
Spoken Word	SignWriting
M - expressive	
macaroni	
machine	
machine gun	
mad	
mad	
mad	



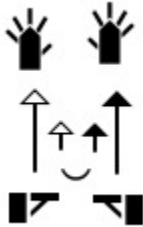



American Sign Language (ASL) Dictionary

Unedited 08082023

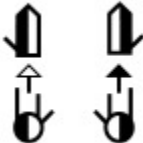
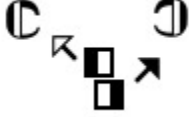
Spoken Word	SignWriting
mad	
Madagascar	
Mae	
magazine	
magazine	
magazine	
magic	
magnet	

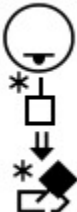





American Sign Language (ASL) Dictionary

Unedited 08082023

Spoken Word	SignWriting
magnificent	
magnify	
magnifying glass	
mail	
mail	
main	
main	
Maine	

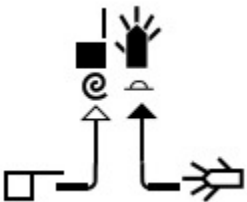





American Sign Language (ASL) Dictionary

Unedited 08082023

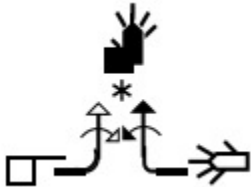
Spoken Word	SignWriting
Maine	
Maine	
mainstream	
mainstream	
mainstream	
mainstream	
mainstream	



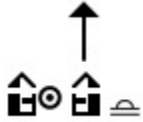

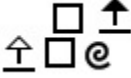
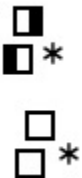
American Sign Language (ASL) Dictionary

Unedited 08082023

Spoken Word	SignWriting
mainstream	
mainstream	
major	
major	
major	
make	
make	
make	

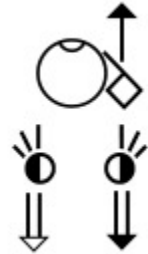

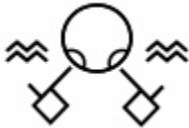
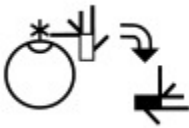

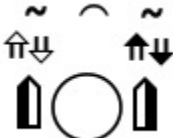
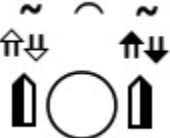

American Sign Language (ASL) Dictionary

Unedited 08082023

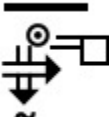
Spoken Word	SignWriting
make	 
make up your mind	
make-believe	
make-sure	
makeup	
malady	
Malaysia	
Malaysian	

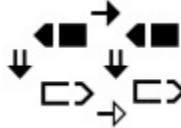
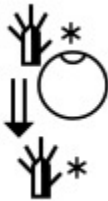





American Sign Language (ASL) Dictionary

Unedited 08082023

Spoken Word	SignWriting
Malta	
Maltese	
mammal	
mammogram	
man	
man	
man	
man	





American Sign Language (ASL) Dictionary

Unedited 08082023

Spoken Word	SignWriting
man	
man	
man	
man	
man	
man	
man	



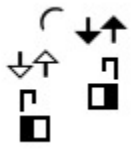
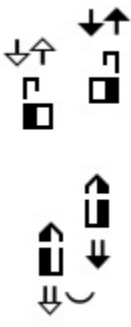
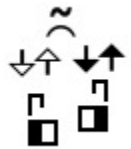
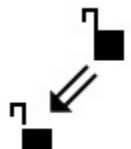

American Sign Language (ASL) Dictionary

Unedited 08082023

Spoken Word	SignWriting
man eyegaze right	
man-left	
manage	
manager	
manager	
mandate	
mango	

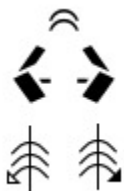

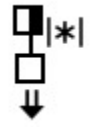
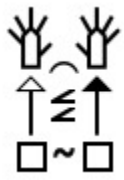
American Sign Language (ASL) Dictionary

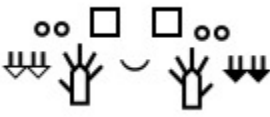
Unedited 08082023

Spoken Word	SignWriting
manipulate	
maniputlate	
manufacture	
manure	
many	
many	
many	



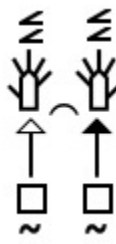
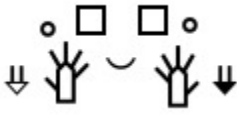
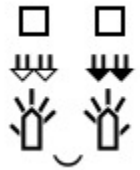
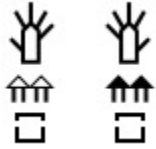
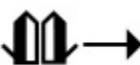
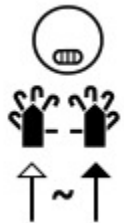



American Sign Language (ASL) Dictionary

Unedited 08082023

Spoken Word	SignWriting
many	
many	
many	
many	
many books	
many buildings	
map	
Mara	





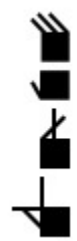

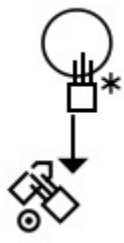

American Sign Language (ASL) Dictionary

Unedited 08082023

Spoken Word	SignWriting
March	
March	
Margaret	
Mari	
marine corps	
mark	
Mark	
Mark 07_31-37d	

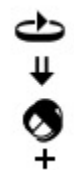





American Sign Language (ASL) Dictionary

Unedited 08082023

Spoken Word	SignWriting
marker	
market, store	
Marlee Matlin	
marriage	
marriage	
marry	
marry	
marry	
marry	





American Sign Language (ASL) Dictionary

Unedited 08082023

Spoken Word	SignWriting
marry	
marry	
marry	
marry	
mars	
marshall	
marshmallow	



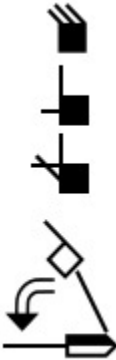



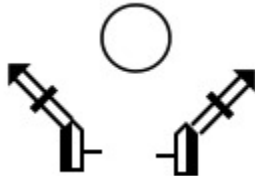

American Sign Language (ASL) Dictionary

Unedited 08082023

Spoken Word	SignWriting
martial arts	
Martin	
Martin Luther King, Jr. Day	
Marvel	
marvel	

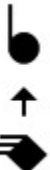



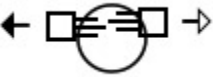

American Sign Language (ASL) Dictionary

Unedited 08082023

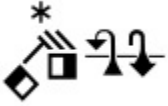
Spoken Word	SignWriting
marvel	
marvelous	
Maryland	
Maryland	
Maryland	
Maryland	
mash	
mashed	
mask	



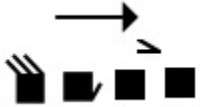

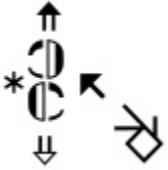
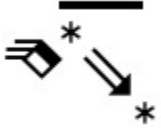





American Sign Language (ASL) Dictionary

Unedited 08082023

Spoken Word	SignWriting
masquerade	
mass	
Massachusetts	
Massachusetts	
Massachusetts	
Massachusetts	
massacre	
mast	
Master	

American Sign Language (ASL) Dictionary

Unedited 08082023

Spoken Word	SignWriting
match	
match	
match	
match	
match - for fire	
material raining down	
math	
math	
math	
matter	







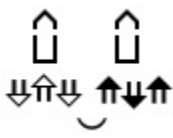

American Sign Language (ASL) Dictionary

Unedited 08082023

Spoken Word	SignWriting
Matthew	
Matthew 10:29	
mature	
Maxed-out	
maximum	
maximum	
May	
maybe	

American Sign Language (ASL) Dictionary

Unedited 08082023

Spoken Word	SignWriting
maybe	
mayor	
McDonald's	
McDonald-'s	
McDonalds	
McDonalds	
McDonalds	
McDonalds	
McDonalds	





American Sign Language (ASL) Dictionary

Unedited 08082023

Spoken Word	SignWriting
mdecine - taking	<p>The signwriting consists of two parts. The first part is a circle with a horizontal line through its center, four dots (two on the left, two on the right) positioned below the line, and a stylized 'L' shape below the dots. The second part is a stylized 'K' shape with an arrow pointing to the right, positioned above a square with an arrow pointing to the right, and an asterisk below the square.</p>
me	<p>A square with an arrow pointing to the right, positioned above an asterisk.</p>
me	<p>A square with an arrow pointing to the right, positioned above an asterisk.</p>
me	<p>A circle with two parallel diagonal lines inside, positioned above a square with an arrow pointing to the right, which is positioned above an asterisk.</p>
me	<p>A square with an arrow pointing to the right, positioned above an asterisk.</p>
me	<p>A circle with two parallel diagonal lines inside, positioned above a square with an arrow pointing to the right, which is positioned above an asterisk.</p>
me	<p>A square with an arrow pointing to the right, positioned above an asterisk.</p>
me	<p>A square with an arrow pointing to the right, positioned above an asterisk.</p>

American Sign Language (ASL) Dictionary

Unedited 08082023

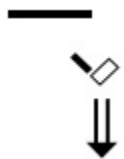
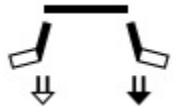
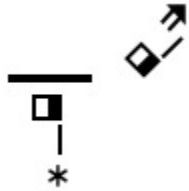
Spoken Word	SignWriting
me	
me	
me	
me	
me	
me	
me-2h	
Me-God	









American Sign Language (ASL) Dictionary

Unedited 08082023

Spoken Word	SignWriting
me-help-you	
me-helping-her	
me-helping-him	
me-helping-you	
me-helps-her	
me-helps-her	
me-helps-him	
me-helps-you	

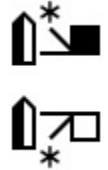

American Sign Language (ASL) Dictionary

Unedited 08082023

Spoken Word	SignWriting
me-question	
me-too	
meadow	
meager	
mean	
mean	
mean	
mean	



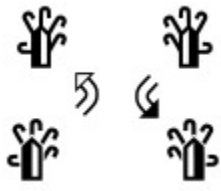
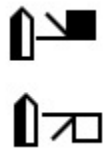
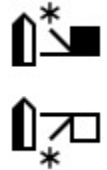
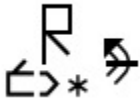

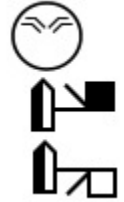



American Sign Language (ASL) Dictionary

Unedited 08082023

Spoken Word	SignWriting
mean	
mean - trait	
mean-2	
meaning	
meaning	
meaning	
means	

American Sign Language (ASL) Dictionary

Unedited 08082023

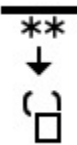
Spoken Word	SignWriting
means	
measurement	
measurement	
meat	
meat	
meat	
meat	
mechanic	
mecicine	
medal	

American Sign Language (ASL) Dictionary

Unedited 08082023

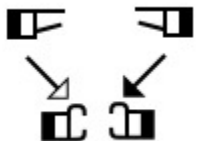
Spoken Word	SignWriting
medallion	 The SignWriting diagram for 'medallion' consists of two hand positions. The left hand starts with the index finger pointing up and the thumb pointing left. The right hand starts with the index finger pointing up and the thumb pointing right. Arrows from both hands point towards a final sign that is a square with a vertical line on the left side and a horizontal line on the top side.







American Sign Language (ASL) Dictionary

Unedited 08082023

Spoken Word	SignWriting
media consultant	<p>The signwriting for 'media consultant' consists of three parts: a hand with fingers spread and a starburst above it, a hand with fingers spread and a starburst above it, and two vertical arrows pointing up and down.</p>
mediate	<p>The signwriting for 'mediate' consists of a hand with fingers spread and a starburst above it, and a circle.</p>
medical	<p>The signwriting for 'medical' consists of a hand with fingers spread and a starburst above it, and a hand with fingers spread and a starburst above it.</p>
medical alert	<p>The signwriting for 'medical alert' consists of a hand with fingers spread and a starburst above it, and a hand with fingers spread and a starburst above it.</p>
medical trash	<p>The signwriting for 'medical trash' consists of a hand with fingers spread and a starburst above it, and a hand with fingers spread and a starburst above it.</p>
Medicare	<p>The signwriting for 'Medicare' consists of a hand with fingers spread and a starburst above it, and a hand with fingers spread and a starburst above it.</p>
medicine	<p>The signwriting for 'medicine' consists of a hand with fingers spread and a starburst above it, and a hand with fingers spread and a starburst above it.</p>



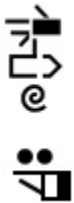

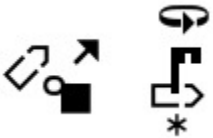

American Sign Language (ASL) Dictionary

Unedited 08082023

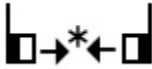
Spoken Word	SignWriting
medicine	
medicine	
medicine bottle	
medicine cabinet	
medicine dropper	
medicine-dropper	
medium	
medium font	
meek, meekness	



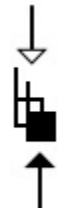

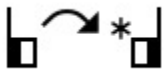
American Sign Language (ASL) Dictionary

Unedited 08082023

Spoken Word	SignWriting
Meet	
Meet	
meet	
meet	
meet	
meet	
meet	
meet	
meet	

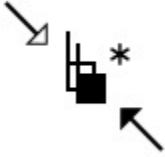
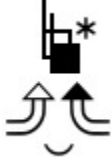
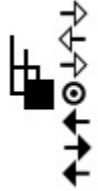

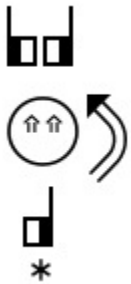
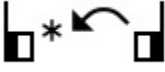

American Sign Language (ASL) Dictionary

Unedited 08082023

Spoken Word	SignWriting
meet	
meet	
meet	
meet	
meet - corrected	
meet-in-heaven	
meet-one-to-one	
meet-one-to-one	

American Sign Language (ASL) Dictionary

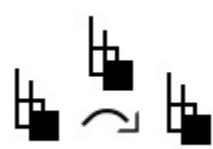
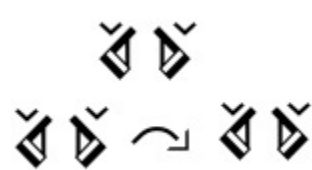
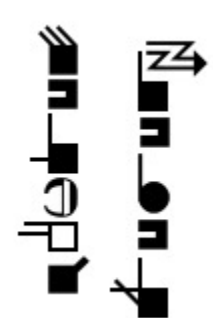
Unedited 08082023

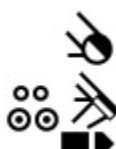
Spoken Word	SignWriting
meeting	
meeting	
meeting	
meetings	
Melchizedek	
melon	
melon	
melon	

American Sign Language (ASL) Dictionary

Unedited 08082023

Spoken Word	SignWriting
meltdown	<p>The SignWriting for 'meltdown' consists of a circle containing a horizontal bar with three vertical lines below it. Below this are two hands, each with an arrow pointing up from the palm side. Below the hands are two more hands, each with an arrow pointing up from the back side.</p>
melting clock	<p>The SignWriting for 'melting clock' consists of a square with a diagonal line and an asterisk, followed by a circle with a horizontal bar and an asterisk, and finally a square with a diagonal line and an asterisk.</p>
member	<p>The SignWriting for 'member' consists of a vertical line, a hand with an arrow pointing down, and two asterisks.</p>
memories	<p>The SignWriting for 'memories' consists of a circle with a horizontal bar and an asterisk, a hand with an arrow pointing down, and a wavy line.</p>
memories	<p>The SignWriting for 'memories' consists of a circle with a horizontal bar and an asterisk, a hand with an arrow pointing down, and a curved arrow.</p>
memories	<p>The SignWriting for 'memories' consists of a circle with a horizontal bar and an asterisk, a hand with an arrow pointing down, a square with a diagonal line and an asterisk, a horizontal line with an asterisk, a circle with a horizontal bar and an asterisk, a hand with an arrow pointing down, and a hand with an arrow pointing down.</p>

American Sign Language (ASL) Dictionary

Unedited 08082023

Spoken Word	SignWriting
memorize	
menorah	
menstruation	
menstruation	
Mental Clarity	
mental-health	
Mentality	
mention	





American Sign Language (ASL) Dictionary

Unedited 08082023

Spoken Word	SignWriting
menu	<p>The SignWriting for 'menu' consists of three parts: a circle with a horizontal line inside and an asterisk, a hand sign with a curved arrow above it and an asterisk, and a hand sign with a vertical line and an asterisk.</p>
menus-sign	<p>The SignWriting for 'menus-sign' consists of two parts: a hand sign with a vertical line and an arrow pointing down, and a hand sign with two fingers pointing up and down.</p>
menus-sign-word	<p>The SignWriting for 'menus-sign-word' consists of four parts: a hand sign with a vertical line and an arrow pointing down, a hand sign with two fingers pointing up and down, a hand sign with two fingers pointing up and down, and a hand sign with a vertical line and an asterisk.</p>
menus-word	<p>The SignWriting for 'menus-word' consists of two parts: a hand sign with a vertical line and an arrow pointing down, and a hand sign with a vertical line and an asterisk.</p>
mercury	<p>The SignWriting for 'mercury' consists of three parts: a hand sign with a vertical line and an asterisk, a hand sign with a vertical line and an arrow pointing up, and a hand sign with a vertical line and an asterisk.</p>
mercy	<p>The SignWriting for 'mercy' consists of four parts: a hand sign with two fingers pointing up and down, a hand sign with two fingers pointing up and down, a hand sign with a curved arrow, and a hand sign with a curved arrow.</p>
mercy-God	<p>The SignWriting for 'mercy-God' consists of five parts: a hand sign with two fingers pointing up and down, a hand sign with two fingers pointing up and down, a hand sign with two fingers pointing up and down, a hand sign with two fingers pointing up and down, and a hand sign with two fingers pointing up and down.</p>

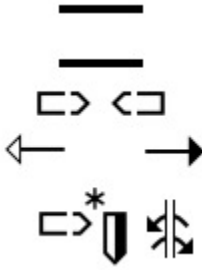

American Sign Language (ASL) Dictionary

Unedited 08082023

Spoken Word	SignWriting
merely	
mermaid	
Merry-Christmas	
Merry-Christmas	
Merry-Christmas	
Merry-Christmas	

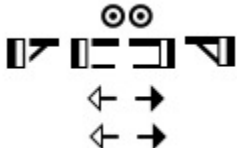
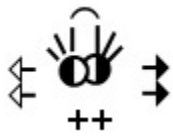
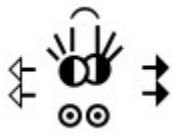
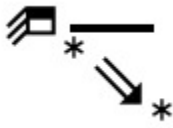

American Sign Language (ASL) Dictionary

Unedited 08082023

Spoken Word	SignWriting
Merry-Christmas	
message	
message	
message	
Message to DeafVision	
Messiah	
messiah	
messy	



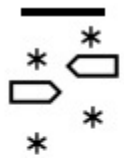

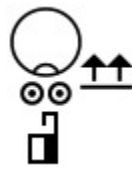
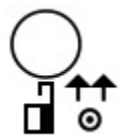
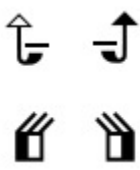
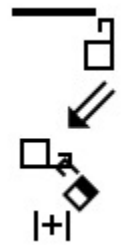

American Sign Language (ASL) Dictionary

Unedited 08082023

Spoken Word	SignWriting
metabolism	 
metal	
metal	
metal	
method	
Mexican	



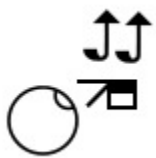
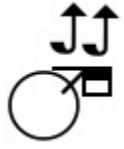





American Sign Language (ASL) Dictionary

Unedited 08082023

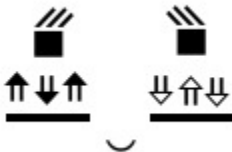
Spoken Word	SignWriting
Mexican	 <p>The SignWriting symbol for 'Mexican' consists of a horizontal line at the top left, a vertical line extending downwards from its right end, a small square to the right of the vertical line, and a small square below the vertical line. To the right of these elements is a small asterisk, and further right is a small square with a diagonal line through it.</p>
Mexican	 <p>The SignWriting symbol for 'Mexican' consists of a horizontal line at the top left, a vertical line extending downwards from its right end, a small square to the right of the vertical line, and a small square below the vertical line. To the right of these elements is a small asterisk, and further right is a small square with a diagonal line through it.</p>
Mexico	 <p>The SignWriting symbol for 'Mexico' consists of a circle on the left, a vertical line extending upwards from its right side, a small square to the right of the vertical line, and a small square below the vertical line.</p>
Mexico	 <p>The SignWriting symbol for 'Mexico' consists of a circle on the left, a vertical line extending upwards from its right side, a small square to the right of the vertical line, and a small square below the vertical line. A small asterisk is located to the left of the vertical line.</p>
Mexico	 <p>The SignWriting symbol for 'Mexico' consists of a circle on the left, a vertical line extending upwards from its right side, a small square to the right of the vertical line, and a small square below the vertical line. Two small upward-pointing arrows are positioned above the vertical line.</p>
Mexico	 <p>The SignWriting symbol for 'Mexico' consists of a circle on the left, a vertical line extending upwards from its right side, a small square to the right of the vertical line, and a small square below the vertical line. Two small upward-pointing arrows are positioned above the vertical line.</p>
Mexico	 <p>The SignWriting symbol for 'Mexico' consists of a circle on the left, a vertical line extending upwards from its right side, a small square to the right of the vertical line, and a small square below the vertical line. A small asterisk is located to the left of the vertical line.</p>
Mexico	 <p>The SignWriting symbol for 'Mexico' consists of a circle on the left, a vertical line extending upwards from its right side, a small square to the right of the vertical line, and a small square below the vertical line. A small asterisk is located to the left of the vertical line, and a small circle with a dot inside is positioned to the right of the vertical line.</p>

American Sign Language (ASL) Dictionary

Unedited 08082023

Spoken Word	SignWriting
Mexico	
mice	
Michael	
Michigan	
Michigan	
Michigan	
Michigan	
Mickey Mouse	

American Sign Language (ASL) Dictionary

Unedited 08082023

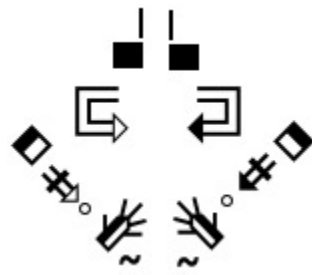
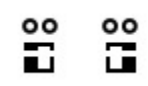
Spoken Word	SignWriting
microwave	
microwave	









American Sign Language (ASL) Dictionary

Unedited 08082023

Spoken Word	SignWriting
microwave 2	
midday, noon	
middle	
midget	
midnight	
midnight	



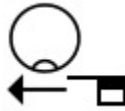





American Sign Language (ASL) Dictionary

Unedited 08082023

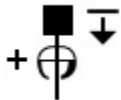
Spoken Word	SignWriting
mile	
military	
military	
milk	
milkman	
million	
Milwaukee	
mind	
mind	



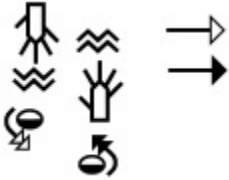



American Sign Language (ASL) Dictionary

Unedited 08082023

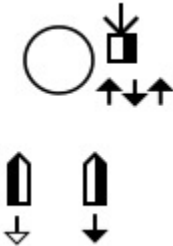
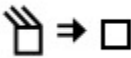
Spoken Word	SignWriting
mind	
mind	
mind blown	
MIND-BEND	
mine	
mine	
mingle	
minimum	
minimum	

American Sign Language (ASL) Dictionary

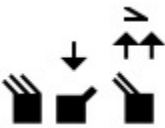
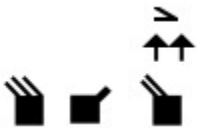
Unedited 08082023

Spoken Word	SignWriting
minimum	
minister	
ministerial-servant	
Minneapolis	
Minnesota	
Minnesota	
Minnesota	
Minnesota	
minor	









American Sign Language (ASL) Dictionary

Unedited 08082023

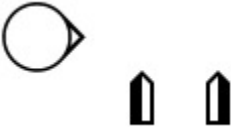
Spoken Word	SignWriting
minor	
minus	
minute	
minute	
minute	
minute	
minute-tick	
miracle	



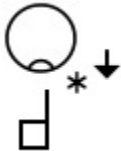



American Sign Language (ASL) Dictionary

Unedited 08082023

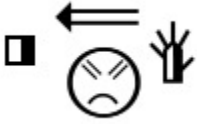
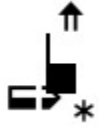
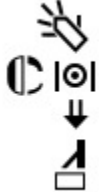
Spoken Word	SignWriting
mirror	
mirror	
mirror	
mirror	
mischievous	
miss	
miss	
miss someone	







American Sign Language (ASL) Dictionary

Unedited 08082023

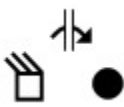
Spoken Word	SignWriting
missed	
missile	
missing	
missionary	
Mississippi	
Mississippi	
Mississippi	
Missouri	
Missouri	

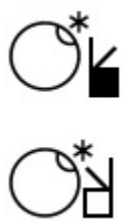





American Sign Language (ASL) Dictionary

Unedited 08082023

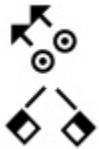
Spoken Word	SignWriting
Missouri	
mistake	
misunderstand	
misunderstand	
misunderstand	
mix	
mix-up	

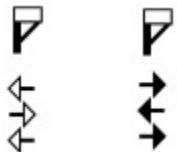

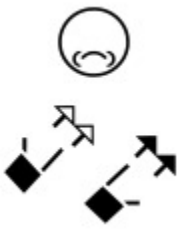
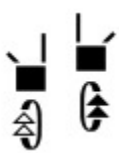
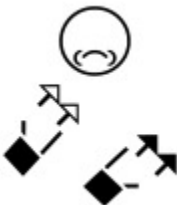



American Sign Language (ASL) Dictionary

Unedited 08082023

Spoken Word	SignWriting
mixed-culture	
mmm	
mobile	
mobile home	
mock	
mock	
mock	
MOCK	

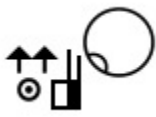
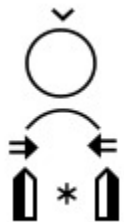



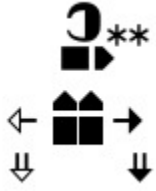



American Sign Language (ASL) Dictionary

Unedited 08082023

Spoken Word	SignWriting
Model	
moderately curly hair	
modrý	
molitev	
mom	
mom	
mom	
monastery	



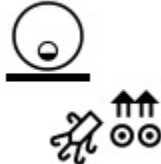



American Sign Language (ASL) Dictionary

Unedited 08082023

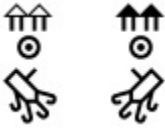
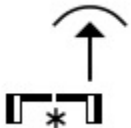
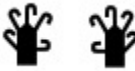
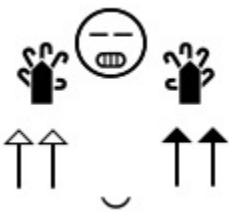
Spoken Word	SignWriting
Monday	
Monday	
money	
money	
money	
money	
money	
monkey	
monkey	

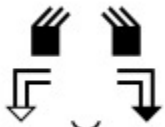
American Sign Language (ASL) Dictionary

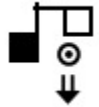
Unedited 08082023

Spoken Word	SignWriting
monkey	
monotone	
monster	
monster	
Monster	
Montana	
Montana	
month	
month	





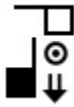

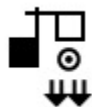
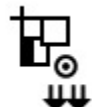

American Sign Language (ASL) Dictionary

Unedited 08082023

Spoken Word	SignWriting
month	 The SignWriting symbol for 'month' consists of a square box at the top right, a vertical line extending downwards from its bottom-left corner, a solid black square at the bottom left, a circle with a dot in the center to the right of the vertical line, and a downward-pointing arrow at the bottom right.







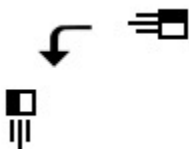

American Sign Language (ASL) Dictionary

Unedited 08082023

Spoken Word	SignWriting
monthly	
monthly	
Monument	
MOOD	
moon	
moon	
moon	
moose	
moose	

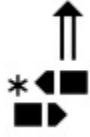

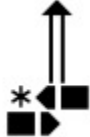

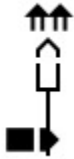

American Sign Language (ASL) Dictionary

Unedited 08082023

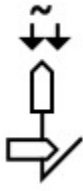
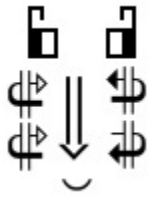
Spoken Word	SignWriting
moral	
more	
more	
more and more	
more than	
more-more	
more-than	
Mormon	
morning	



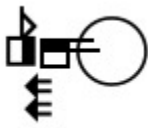



American Sign Language (ASL) Dictionary

Unedited 08082023

Spoken Word	SignWriting
morning	
morphology	
morphology	
morphology	
Moses	
Moses	
Mosque	

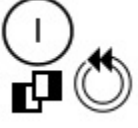



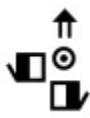
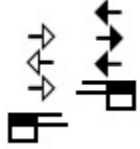





American Sign Language (ASL) Dictionary

Unedited 08082023

Spoken Word	SignWriting
mosquito	
mosquito	
mosquito	
most	
most	
most-of-the-time	
mostly	
motel	







American Sign Language (ASL) Dictionary

Unedited 08082023

Spoken Word	SignWriting
mother	
mother	
mother	
mother	
mother	
mother	
mother	
mother	
Mother	
mother	



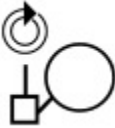

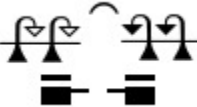
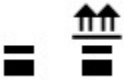
American Sign Language (ASL) Dictionary

Unedited 08082023

Spoken Word	SignWriting
mother	
mother	
mother-in-law	
mother-left-hand	
motivate	
motive	
motorcycle	
motorcycle	
motorcycle	



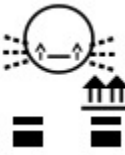
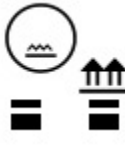

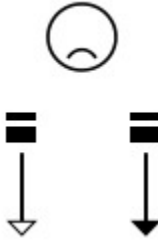
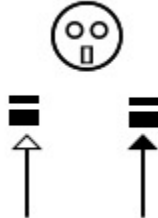

American Sign Language (ASL) Dictionary

Unedited 08082023

Spoken Word	SignWriting
motorcycle	
motorcycle	
motorcycle	
motorcycle	
motorcycle falls down away from legs classifier	
motorcycle goes straight down	
motorcycle shoots forward screaming	

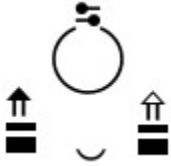





American Sign Language (ASL) Dictionary

Unedited 08082023

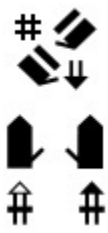
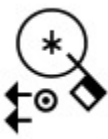
Spoken Word	SignWriting
motyl	
mound	
mount bike	
mountain	
mountain	
mountain	

American Sign Language (ASL) Dictionary

Unedited 08082023

Spoken Word	SignWriting
mountain	
mouse	
mouse	
mouth	
mouth	
mouth closed	
mouth mm down lips	







American Sign Language (ASL) Dictionary

Unedited 08082023

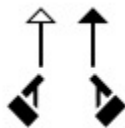
Spoken Word	SignWriting
mouth movements small	<p>The SignWriting symbols for 'mouth movements small' are arranged in two columns. The left column contains five symbols: a circle with a wavy line above it, a circle with a horizontal line through it, a circle with a vertical line through it, a circle with a wavy line below it, and a circle with a horizontal line through it and a wavy line below it. The right column contains four symbols: a circle with a horizontal line through it and a wavy line above it, a circle with a horizontal line through it and a wavy line below it, a circle with a horizontal line through it and a wavy line below it, and a circle with a horizontal line through it and a wavy line below it.</p>
mouth oo	<p>The SignWriting symbol for 'mouth oo' is a circle with a small dot in the center.</p>
mouth open	<p>The SignWriting symbol for 'mouth open' is a circle with a small circle inside and an upward-pointing arrow above it.</p>
mouth pursed shut	<p>The SignWriting symbol for 'mouth pursed shut' is a circle with a small circle inside, an upward-pointing arrow above it, and a horizontal line through the center.</p>
mouth show teeth	<p>The SignWriting symbol for 'mouth show teeth' is a circle with a horizontal line through the center and a small circle inside.</p>
mouthwash	<p>The SignWriting symbols for 'mouthwash' are arranged in three rows. The first row is a circle with a small circle inside and an upward-pointing arrow above it. The second row is a circle with a vertical line through the center and a downward-pointing arrow below it. The third row is a circle with a horizontal line through the center and a small circle inside.</p>
move	<p>The SignWriting symbols for 'move' are two triangles pointing up, each with a curved arrow above it indicating movement.</p>
move	<p>The SignWriting symbols for 'move' are two triangles pointing up, each with a curved arrow above it indicating movement.</p>





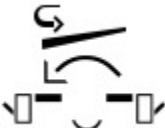

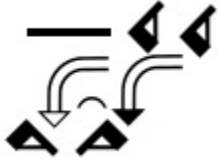

American Sign Language (ASL) Dictionary

Unedited 08082023

Spoken Word	SignWriting
move (object) away from me	
move (object) left	
move (object) right	
move (object) to right	
move (object) towards me	
move away	
move away	
move box to left	





American Sign Language (ASL) Dictionary

Unedited 08082023

Spoken Word	SignWriting
move here	
move rounded object to right	
movement	
Movement Clusters 1	
movement forward left hand	
movement forward right hand	
movement forward right hand	
movement forward right hand	

American Sign Language (ASL) Dictionary

Unedited 08082023

Spoken Word	SignWriting
<p style="text-align: center;">movement right hand circle toward signer</p>	
<p>movie</p>	
<p>movie</p>	
<p>movie</p>	





American Sign Language (ASL) Dictionary

Unedited 08082023

Spoken Word	SignWriting
Movie	
movies	
movies	
mow	
mow (grass)	
Ms-Anderson	
Ms-Dorsett	
much	



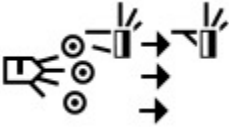
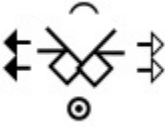
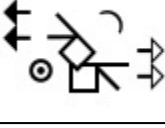

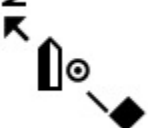
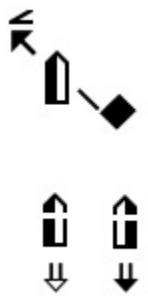

American Sign Language (ASL) Dictionary

Unedited 08082023

Spoken Word	SignWriting
muffle	
mule	
multiple choice	
multiply	
multiply	
mummy	
murder	
murderer	

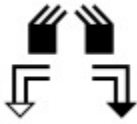

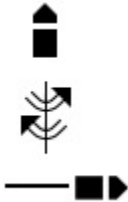

American Sign Language (ASL) Dictionary

Unedited 08082023

Spoken Word	SignWriting
muscle	
muscular	
museum	
mushroom	
mushroom	
mushroom	
music	
music	

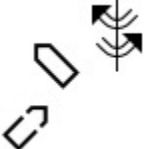
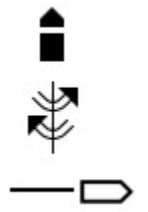
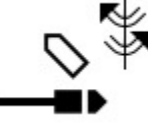







American Sign Language (ASL) Dictionary

Unedited 08082023

Spoken Word	SignWriting
music	
music	
music	
music	
musician	
musician	







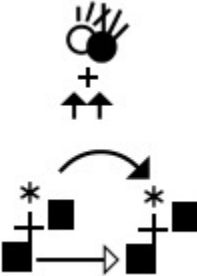

American Sign Language (ASL) Dictionary

Unedited 08082023

Spoken Word	SignWriting
must	
must - 2	
Must - 2 (left)	
mustache	
mustache	
mustard	
mute	
mute	
mutual	







American Sign Language (ASL) Dictionary

Unedited 08082023

Spoken Word	SignWriting
mutualism	
my	
my	
my	
my	
my	
my	
my	
my	



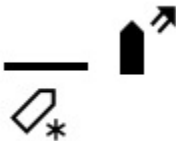









American Sign Language (ASL) Dictionary

Unedited 08082023

Spoken Word	SignWriting
my	
my	
My hair is black	
My hair is black.	
my turn	
my turn	
My-Almighty	
my-left	
myopic	









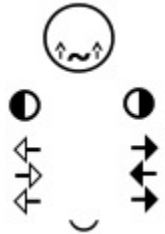

American Sign Language (ASL) Dictionary

Unedited 08082023

Spoken Word	SignWriting
myself	
myself	 
myself	  
myself	
myself	
myself	
myself	
N	
N	
N - expressive	









American Sign Language (ASL) Dictionary

Unedited 08082023

Spoken Word	SignWriting
n-o zero	
naive	
name	
Name	
Name	
name	
name	
name	
name	
name-sign-A	

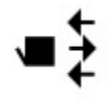

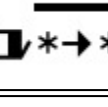





American Sign Language (ASL) Dictionary

Unedited 08082023

Spoken Word	SignWriting
name-sign-A	
name-sign-A	
name-sign-A	
name-sign-A	
name-sign-A	
name-sign-A	
name-sign-A	
name-sign-A	
name-sign-AB	
name-sign-B	





American Sign Language (ASL) Dictionary

Unedited 08082023

Spoken Word	SignWriting
name-sign-B	
name-sign-B	
name-sign-B	
name-sign-B	
name-sign-B	
name-sign-B	
name-sign-B	
name-sign-C-R	
name-sign-CF	







American Sign Language (ASL) Dictionary

Unedited 08082023

Spoken Word	SignWriting
name-sign-CW	
name-sign-D	
name-sign-D	
name-sign-D	

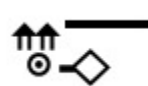
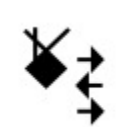

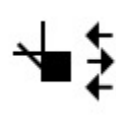

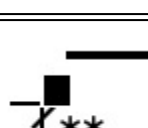
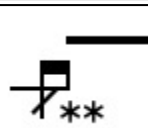



American Sign Language (ASL) Dictionary

Unedited 08082023

Spoken Word	SignWriting
name-sign-E	
name-sign-F	
name-sign-J	
name-sign-K	
name-sign-K	
name-sign-K	
name-sign-M	
name-sign-M	
name-sign-P	
name-sign-P	

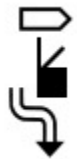







American Sign Language (ASL) Dictionary

Unedited 08082023

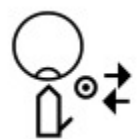
Spoken Word	SignWriting
name-sign-S	
name-sign-S	
name-sign-S	
name-sign-T	
name-sign-V	
name-sign-V	
name-sign-W	
named	
Namibia	

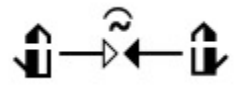





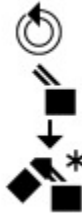

American Sign Language (ASL) Dictionary

Unedited 08082023

Spoken Word	SignWriting
Nampa, Idaho	
napkin	
napkin	
napkin	
napkin	
narrow	
nation	
nation	
national	



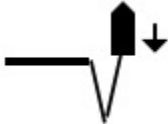



American Sign Language (ASL) Dictionary

Unedited 08082023

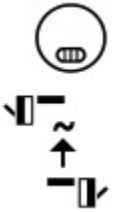
Spoken Word	SignWriting
native	
Native American	
nature	
nausea	
nausea	
navy	
nazi	
NC	









American Sign Language (ASL) Dictionary

Unedited 08082023

Spoken Word	SignWriting
near	
near	
near	
near	
near-left	
near-left	
near-right	

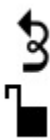



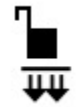



American Sign Language (ASL) Dictionary

Unedited 08082023

Spoken Word	SignWriting
neat	
neat	
Nebraska	
Nebraska	
necessary	
necklace	
Necklace (circles)	
necktie	
need	

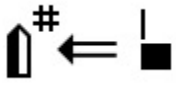





American Sign Language (ASL) Dictionary

Unedited 08082023

Spoken Word	SignWriting
need	
Neelamma	
Neelamma	
Neelamma	
negative	
negative	
negative	
negative	
negative	





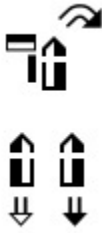



American Sign Language (ASL) Dictionary

Unedited 08082023

Spoken Word	SignWriting
negative with expression	
negative with expression	
neglect	
negotiate	
negotiate	
neighbor	
neighbor	







American Sign Language (ASL) Dictionary

Unedited 08082023

Spoken Word	SignWriting
neighbor	
neighbor	
neighbor	
neighbor	
neighbor	
neighbor	
neighbor	
neighborhood	



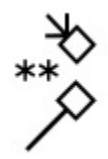



American Sign Language (ASL) Dictionary

Unedited 08082023

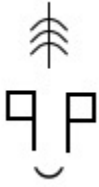
Spoken Word	SignWriting
neighborhood	
neighborhood	
nephew	
nephew	
neptune	
nervous	
nervous	

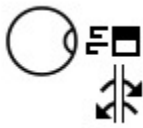
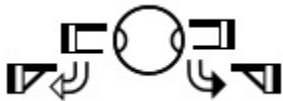





American Sign Language (ASL) Dictionary

Unedited 08082023

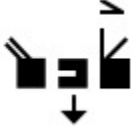
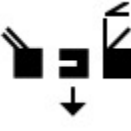
Spoken Word	SignWriting
nervous	
nervous	
nervous	
nervy	
Netherlands	
neutral	
neutron	
Nevada	

American Sign Language (ASL) Dictionary

Unedited 08082023

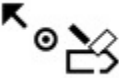
Spoken Word	SignWriting
Nevada	
Nevada	
never	
never	
never	
never	
never8	
new	







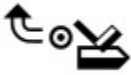

American Sign Language (ASL) Dictionary

Unedited 08082023

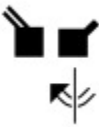
Spoken Word	SignWriting
new	 The SignWriting symbol for 'new' consists of a curved arrow pointing upwards and to the left, a small circle with a dot in the center, and a stylized hand with fingers spread.



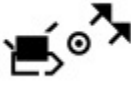





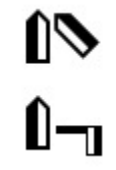

American Sign Language (ASL) Dictionary

Unedited 08082023

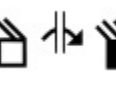
Spoken Word	SignWriting
new	
new	
New Hampshire	
New Jersey	
New Mexico	
New Orleans	
New Year resolution	
New York	
New York	
New York	
New York City	



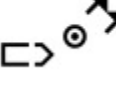





American Sign Language (ASL) Dictionary

Unedited 08082023

Spoken Word	SignWriting
New Zealand	
New-Hampshire	
New-Jersey	
New-Mexico	
New-Mexico	
New-York	
New-York	
New-York	
New-York-City	
news	

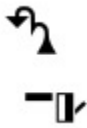

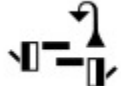





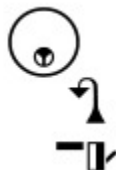

American Sign Language (ASL) Dictionary

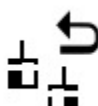
Unedited 08082023

Spoken Word	SignWriting
newspaper	
newspaper	
newspaper	
newspaper	
next	
next	
next	
next	
next	

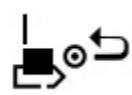
American Sign Language (ASL) Dictionary

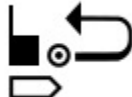
Unedited 08082023

Spoken Word	SignWriting
next	
next	
next	
next	
next to	
next to	
next week	
next week	
next week	
next week	

American Sign Language (ASL) Dictionary

Unedited 08082023

Spoken Word	SignWriting
next year	
next-door	
next-to	
next-to-me	
Nicaragua	
Nicaragua	
Nicaragua	
Nicaragua	
nice	
nice	

American Sign Language (ASL) Dictionary

Unedited 08082023

Spoken Word	SignWriting
nice	
nice both palms down	
nickel	
Nicole	
niece	
niece	
night	
night	
night	
night	







American Sign Language (ASL) Dictionary

Unedited 08082023

Spoken Word	SignWriting
night	
nine dollars	
nine hours	
nine minutes	
nine months	
nine o'clock	
nine of us	
nine of us (left hand)	
nine of us (right hand)	

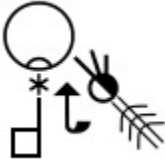
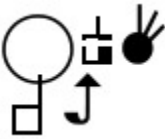
American Sign Language (ASL) Dictionary

Unedited 08082023

Spoken Word	SignWriting
nine years old	
nine years old	
nineteen years old	
nineteen years old	
nineteen years old	
ninety eight	
ninety seven	

American Sign Language (ASL) Dictionary

Unedited 08082023

Spoken Word	SignWriting
ninety six	
ninth	
ninth (in a series) (left hand)	
no	
no	
no	
no	
no	
no	
no	
no	





American Sign Language (ASL) Dictionary

Unedited 08082023

Spoken Word	SignWriting
no	
no facial expression	
no good	
no worries	
no worries	
no-clue	
no-emphatic	
no-good	
no-more	

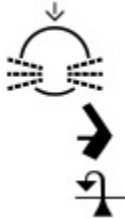





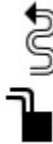

American Sign Language (ASL) Dictionary

Unedited 08082023

Spoken Word	SignWriting
no-no	
no-way	
noble	
nod	
nod	

American Sign Language (ASL) Dictionary

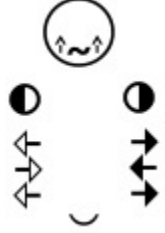
Unedited 08082023

Spoken Word	SignWriting
noise	
nomad	
nominate	
non-manual-signals	
none	
none	
none	
none	
none	







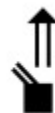

American Sign Language (ASL) Dictionary

Unedited 08082023

Spoken Word	SignWriting
none	
none	
none	
none-3	
noodle	
noon	
noon	
noon	
north	

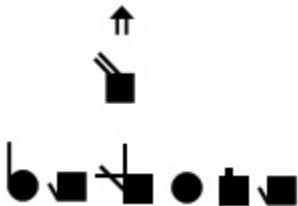







American Sign Language (ASL) Dictionary

Unedited 08082023

Spoken Word	SignWriting
north	
North America	
North America	
North Dakota	
North-Carolina	
North-Dakota	
North-Dakota	
Norway	
Norway	
Norway	





American Sign Language (ASL) Dictionary

Unedited 08082023

Spoken Word	SignWriting
Norway	
Norwegian	
Norwegian	
Norwegian	
Norwegian	
Nose	
nose	
nose	
nose throw away	

American Sign Language (ASL) Dictionary

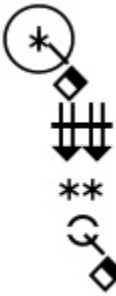
Unedited 08082023

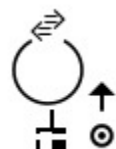
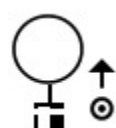
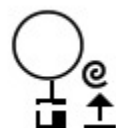
Spoken Word	SignWriting
nosedive	
nosy	
nosy	
Not	
not	
not	
not	

American Sign Language (ASL) Dictionary

Unedited 08082023

Spoken Word	SignWriting
not	<p>The signwriting for 'not' consists of a circle with an upward-pointing arrow above it, a square with a dot inside below it, and a small circle with a dot inside to the right.</p>
not	<p>The signwriting for 'not' consists of a circle with two horizontal lines inside, a square with a dot inside below it, and a downward-pointing arrow to the right.</p>
not crazy about	<p>The signwriting for 'not crazy about' consists of a circle with an upward-pointing arrow above it, a square with a dot inside below it, and a hand with fingers spread below that.</p>
not have	<p>The signwriting for 'not have' consists of a circle with an upward-pointing arrow above it, a square with a dot inside below it, and a hand with fingers spread below that.</p>
not last week	<p>The signwriting for 'not last week' consists of a circle with an upward-pointing arrow above it, a square with a dot inside below it, and a hand with fingers spread below that.</p>
not my job	<p>The signwriting for 'not my job' consists of a circle with two horizontal lines inside, a square with a dot inside below it, and a hand with fingers spread below that.</p>

American Sign Language (ASL) Dictionary

Unedited 08082023

Spoken Word	SignWriting
not next week	<p>The signwriting consists of a circle with a hand icon on top, a square with a vertical line and a dot, and a hand icon with an arrow pointing up.</p>
not often	<p>The signwriting consists of a circle with a hand icon on top, a square with a vertical line and a dot, a hand icon with an arrow pointing down, and a hand icon with an arrow pointing up and two asterisks below it.</p>
not often	<p>The signwriting consists of a circle with a hand icon on top, a square with a vertical line and a dot, a hand icon with an arrow pointing up, and a hand icon with an arrow pointing up and two asterisks below it.</p>
not scared	<p>The signwriting consists of a face with a wide smile, two hand icons with arrows pointing outwards, and two hand icons with arrows pointing inwards.</p>
not yet	<p>The signwriting consists of a circle with a hand icon on top and a dot inside, and a hand icon with an arrow pointing down and two asterisks below it.</p>







American Sign Language (ASL) Dictionary

Unedited 08082023

Spoken Word	SignWriting
not yet	<p>The signwriting for 'not yet' consists of three parts: a circle with a dot inside and a hand icon above it; a vertical line with a horizontal bar at the top and a double-headed arrow to its right; and a hand icon with a double-headed arrow below it.</p>
not-crazy-about	<p>The signwriting for 'not-crazy-about' consists of two parts: a circle with a hand icon above it and a horizontal line below it; and a hand icon with a double-headed arrow below it.</p>
not-satisfied	<p>The signwriting for 'not-satisfied' consists of two parts: a circle with a hand icon above it and a horizontal line below it; and a hand icon with a double-headed arrow below it.</p>
not-yet	<p>The signwriting for 'not-yet' consists of two parts: a circle with a hand icon above it and a horizontal line below it; and a hand icon with a double-headed arrow below it.</p>
notable	<p>The signwriting for 'notable' consists of two parts: a circle with a hand icon above it and a horizontal line below it; and a hand icon with a double-headed arrow below it.</p>
notate	<p>The signwriting for 'notate' consists of two parts: a hand icon with a double-headed arrow below it; and a hand icon with a double-headed arrow below it.</p>

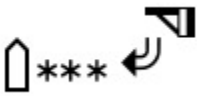

American Sign Language (ASL) Dictionary

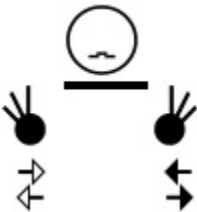
Unedited 08082023

Spoken Word	SignWriting
notate	
notate	
notate	
note	
notes	
notes	
nothing	





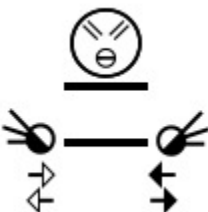
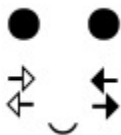
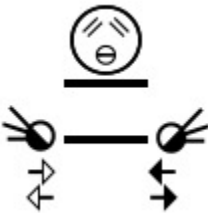
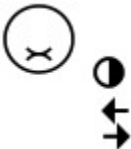

American Sign Language (ASL) Dictionary

Unedited 08082023

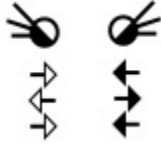
Spoken Word	SignWriting
Nothing	
nothing	
nothing	
nothing	
nothing	
nothing	
nothing	

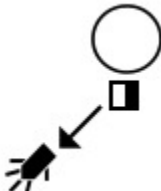



American Sign Language (ASL) Dictionary

Unedited 08082023

Spoken Word	SignWriting
nothing	
nothing	
nothing	
nothing	
nothing	
nothing	
nothing	

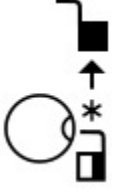

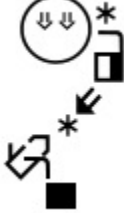

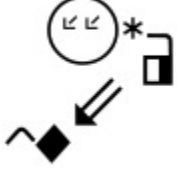
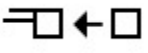

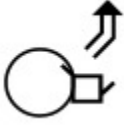

American Sign Language (ASL) Dictionary

Unedited 08082023

Spoken Word	SignWriting
notice	
notice	
notice	
notice	
notice	
notice	
notification	



American Sign Language (ASL) Dictionary

Unedited 08082023

Spoken Word	SignWriting
notion	
notorious	
nouns	
November	
November	
now	
now	
number	
number	



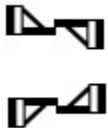



American Sign Language (ASL) Dictionary

Unedited 08082023

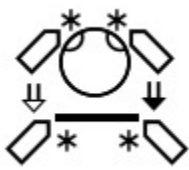
Spoken Word	SignWriting
number	
numerator	

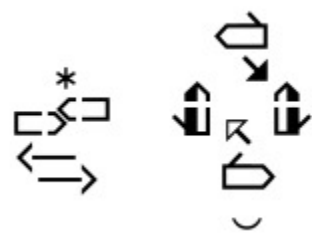

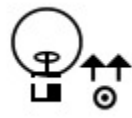







American Sign Language (ASL) Dictionary

Unedited 08082023

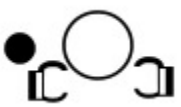
Spoken Word	SignWriting
nun	
nun	
nurse	
nursery	
nut	
nut	
nuts	
nuts	

American Sign Language (ASL) Dictionary

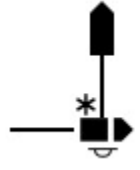
Unedited 08082023

Spoken Word	SignWriting
o	
O	
O	
O	
o'clock	
O- receptive	
o-shake	
Oakland, CA	
oath	
Obama	
obedient	

American Sign Language (ASL) Dictionary

Unedited 08082023

Spoken Word	SignWriting
obey	
obey	
obey	
object	
object appearing, getting larger from behind	
object disappears in the distance	
object disappears in the distance open mouth	
objection	







American Sign Language (ASL) Dictionary

Unedited 08082023

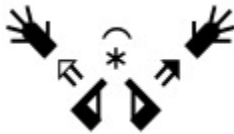
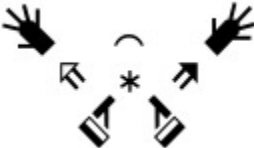
Spoken Word	SignWriting
objectives	
obsess	
obsess	
obsess	
obsession	
obstruct	

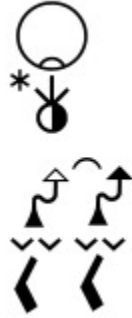







American Sign Language (ASL) Dictionary

Unedited 08082023

Spoken Word	SignWriting
obvious	
obvious	
ocean	
ocean	
ocean	
ocean	
October	

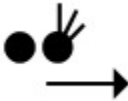

American Sign Language (ASL) Dictionary

Unedited 08082023

Spoken Word	SignWriting
octopus	
oculog	
of	
of course	
off	
off	
off	
off lexicalized	
off lexicalized	
offense	



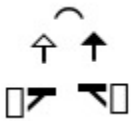

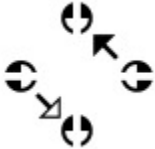
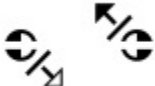
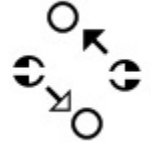
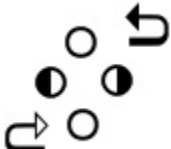
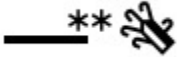

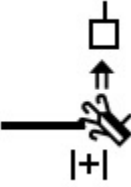

American Sign Language (ASL) Dictionary

Unedited 08082023

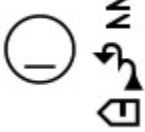
Spoken Word	SignWriting
offer	
offering	
office	
office	
office	
office	
office	
officer	

American Sign Language (ASL) Dictionary

Unedited 08082023

Spoken Word	SignWriting
officer	
official	
often	
often	
often	
oh	
oh	
Oh I see	
oh I see	







American Sign Language (ASL) Dictionary

Unedited 08082023

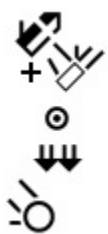
Spoken Word	SignWriting
oh I see	
oh well	
oh wow	
oh-I-see	
oh-i-see	
oh-my-gosh	
oh-no	
oh-no	
oh-well	
Ohio	



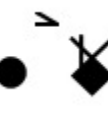
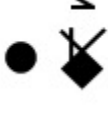
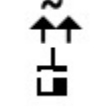



American Sign Language (ASL) Dictionary

Unedited 08082023

Spoken Word	SignWriting
oil	
oil	
OK	
OK	
ok	
ok	
ok	
okay	
Oklahoma	







American Sign Language (ASL) Dictionary

Unedited 08082023

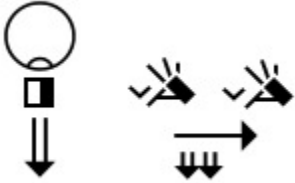
Spoken Word	SignWriting
Oklahoma	
old	
old	
old	
old	
old	
old	

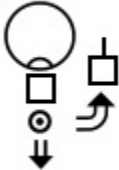



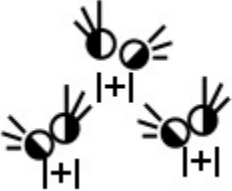

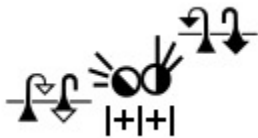

American Sign Language (ASL) Dictionary

Unedited 08082023

Spoken Word	SignWriting
old-fashioned	
old-very	
older	
oldest	
OLGA	
Olimpics	
Olympic	

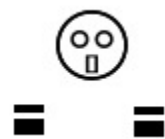







American Sign Language (ASL) Dictionary

Unedited 08082023

Spoken Word	SignWriting
Olympics	
on	
on	
on	
on lexicalized	
on motorcycle screaming	
On Saturday I watch a film	
On Saturday I watch a film.	
on the fence	
on the left	
on the right	

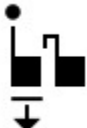
American Sign Language (ASL) Dictionary

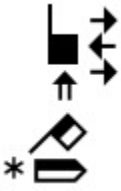
Unedited 08082023

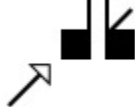
Spoken Word	SignWriting
once	
one	
one cent	
one dollar	
one hundred	
one more	
one o'clock	
one o'clock	
one person meets two	





American Sign Language (ASL) Dictionary

Unedited 08082023

Spoken Word	SignWriting
one to ten	
one year ago	
one year old	
one year old	
one-to-three	
onion	
onion	
onion	
onion	



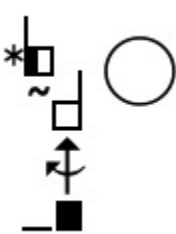
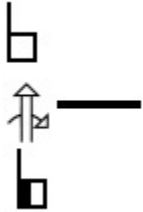





American Sign Language (ASL) Dictionary

Unedited 08082023

Spoken Word	SignWriting
online	
only	
only (left hand)	
only-one	
only-one	
only-one	
only-one	

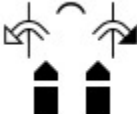

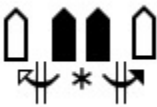





American Sign Language (ASL) Dictionary

Unedited 08082023

Spoken Word	SignWriting
oops	
oops	
oops	
open	
open	
open	
open	
open	
open book	



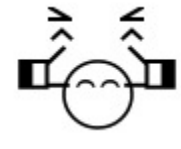



American Sign Language (ASL) Dictionary

Unedited 08082023

Spoken Word	SignWriting
open box flaps front to back	
open box flaps side to side	
open chest	
open door	
open door	
open door	
open eyes	
open knuckles twice	
open window	

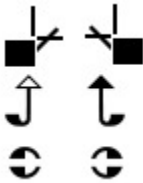
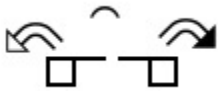





American Sign Language (ASL) Dictionary

Unedited 08082023

Spoken Word	SignWriting
open-window	
opinion	
opportunity	
oppose	
opposite	
oppress	
oppressed	
oppression	



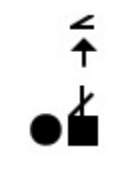





American Sign Language (ASL) Dictionary

Unedited 08082023

Spoken Word	SignWriting
oppression	
options	
options	
optometrist	
or	
or	
or	



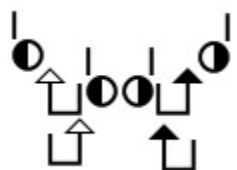

American Sign Language (ASL) Dictionary

Unedited 08082023

Spoken Word	SignWriting
oral education	
orange	
orange	
orange	
orange	
orange	
Orchestra	
ordain	

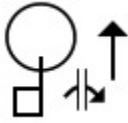

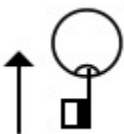
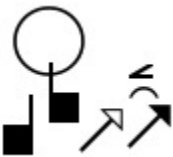
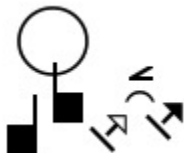
American Sign Language (ASL) Dictionary

Unedited 08082023

Spoken Word	SignWriting
order	
order	
order	
order	
order	
order	
ordinary	



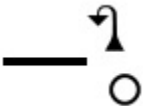
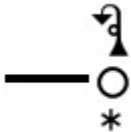
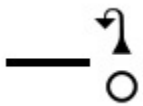
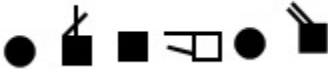
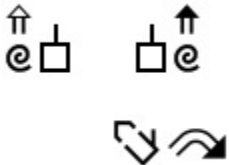
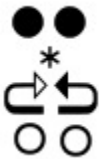



American Sign Language (ASL) Dictionary

Unedited 08082023

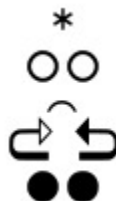
Spoken Word	SignWriting
ordinary	
Oregon	
Oregon	
Oregon	
Oregon	
organism	
organization	
organization	

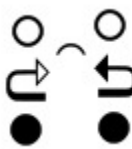

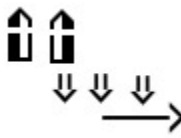

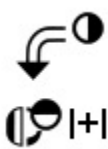
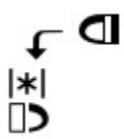

American Sign Language (ASL) Dictionary

Unedited 08082023

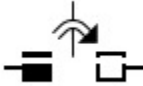
Spoken Word	SignWriting
organization	
organization	
organization	
organization	
organize	
orthodox	
ostrich	
Ostrich	

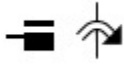
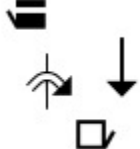
American Sign Language (ASL) Dictionary

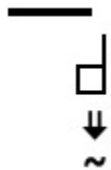
Unedited 08082023

Spoken Word	SignWriting
other	
other	
other	
other	
other - left hand	
other person	
other person - emphasis	
OTHERWISE	







American Sign Language (ASL) Dictionary

Unedited 08082023

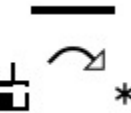
Spoken Word	SignWriting
otherwise	<p>The signwriting for 'otherwise' consists of two parts. The top part shows a hand with fingers spread, palm facing left, positioned above a solid black circle. The bottom part shows a circle with two horizontal lines inside, positioned above a small square with a vertical line through its center. To the right of this square is a small circle with a dot in the center, and an arrow points upwards from the square towards this dot.</p>
our	<p>The signwriting for 'our' features a horizontal line at the top. Below it, two hands are shown with palms facing each other. Each hand has an asterisk (*) next to it. In the center, between the hands, is a vertical line with a horizontal crossbar.</p>
our	<p>The signwriting for 'our' shows two hands with palms facing each other, each with an asterisk (*) next to it. In the center, between the hands, is a vertical line with a horizontal crossbar.</p>
our	<p>The signwriting for 'our' features a horizontal line at the top. Below it, two hands are shown with palms facing each other, each with an asterisk (*) next to it. A curved arrow indicates a rotation from the right hand towards the left hand.</p>
our	<p>The signwriting for 'our' features a horizontal line at the top. Below it, two hands are shown with palms facing each other, each with an asterisk (*) next to it. A curved arrow indicates a rotation from the left hand towards the right hand.</p>
our - rotation left	<p>The signwriting for 'our - rotation left' features a horizontal line at the top. Below it, two hands are shown with palms facing each other, each with an asterisk (*) next to it. In the center, between the hands, is a vertical line with a horizontal crossbar.</p>
our - rotation - right	<p>The signwriting for 'our - rotation - right' features a horizontal line at the top. Below it, two hands are shown with palms facing each other, each with an asterisk (*) next to it. In the center, between the hands, is a vertical line with a horizontal crossbar.</p>
our-2h	<p>The signwriting for 'our-2h' shows two hands with palms facing each other, each with an asterisk (*) next to it. A curved arrow indicates a rotation from the right hand towards the left hand.</p>

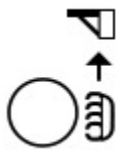





American Sign Language (ASL) Dictionary

Unedited 08082023

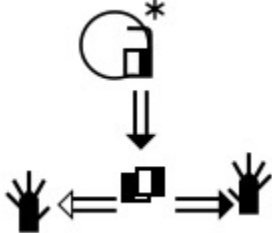
Spoken Word	SignWriting
ourselves	
ourselves - left	
out	
out	
out	
out	
out	
out	







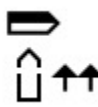

American Sign Language (ASL) Dictionary

Unedited 08082023

Spoken Word	SignWriting
out-of-bounds	
outburst	
outgoing	
Outlands	
outside	
outside	
outside	



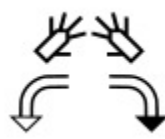

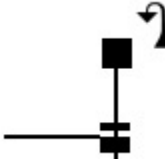
American Sign Language (ASL) Dictionary

Unedited 08082023

Spoken Word	SignWriting
outside	
oven	
over	
over	
over-the-week-end	
over-there	
overalls	
overarching	
overcome	
overcome	

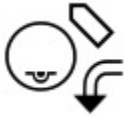

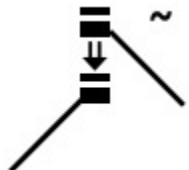
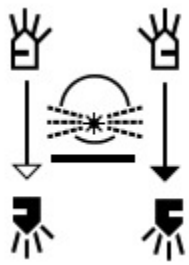
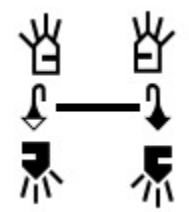

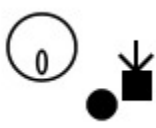



American Sign Language (ASL) Dictionary

Unedited 08082023

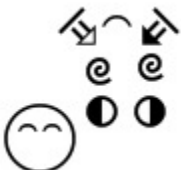
Spoken Word	SignWriting
overflowing	
overlook	
overlook	
overwhelm	
overwhelm	
overwhelm	
overwhelming	
ow	







American Sign Language (ASL) Dictionary

Unedited 08082023

Spoken Word	SignWriting
owe	
owe	
owl	
own	
own	
P	
P - Receptive	
pace	
Pacific Daylight Time	
pacific ocean	

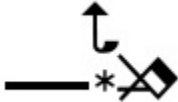
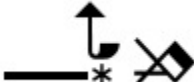
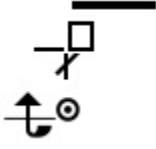
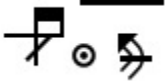





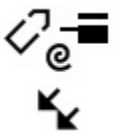

American Sign Language (ASL) Dictionary

Unedited 08082023

Spoken Word	SignWriting
pack	
pad	
pagan	
Pagan	
Pagan	
pagan- religion	
Pagan--religion-	
page	
page	



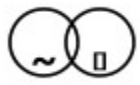
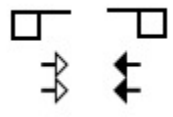

American Sign Language (ASL) Dictionary

Unedited 08082023

Spoken Word	SignWriting
page	
pager	
pager	
pager	
PAH	
PAH	
PAH	
pain	
paint	



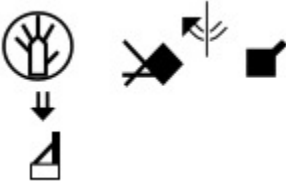





American Sign Language (ASL) Dictionary

Unedited 08082023

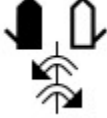
Spoken Word	SignWriting
painting	
painting	
pair	
pajamas	
Pakistan	
Pakistani	
palavra 1 - atividade Escrita de Sinais 2	
palavra 2 - atividade Escrita de Sinais 2	







American Sign Language (ASL) Dictionary

Unedited 08082023

Spoken Word	SignWriting
pale	
palm orientation	
palm orientation	
pamphlet	
pamphlet	
pamphlet	
pamphlet	
pamphlet	





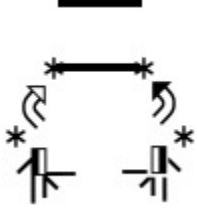

American Sign Language (ASL) Dictionary

Unedited 08082023

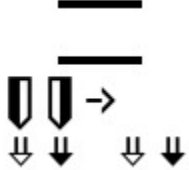
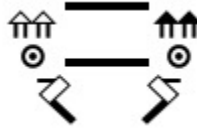
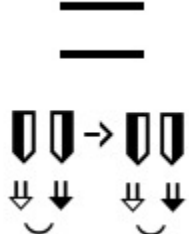
Spoken Word	SignWriting
pancake	
pancake	
panda	
panda	
panphlet	
panther	
panties	



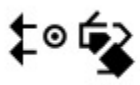



American Sign Language (ASL) Dictionary

Unedited 08082023

Spoken Word	SignWriting
panties2	
pants	
pants	
pants	
paper	
paper	
paper	
paper	
paper	



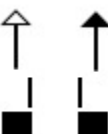

American Sign Language (ASL) Dictionary

Unedited 08082023

Spoken Word	SignWriting
paper	
Papua New Guinea	
parade	
Paraguay	
parakeet	
parallel	
paranoid	
parasite	

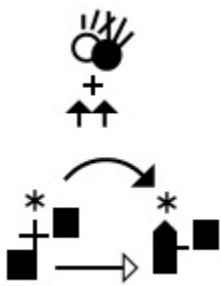
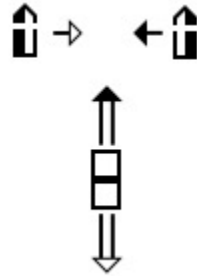
American Sign Language (ASL) Dictionary

Unedited 08082023

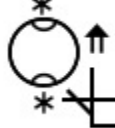
Spoken Word	SignWriting
parasitism	
parasol	
parch	
parents	
parents	
parents	

American Sign Language (ASL) Dictionary

Unedited 08082023

Spoken Word	SignWriting
parents	
parents	
parents	
pariah	
Paris	
Paris	
parish	
park	





American Sign Language (ASL) Dictionary

Unedited 08082023

Spoken Word	SignWriting
park	The signwriting for 'park' consists of a curved arrow pointing right, followed by a diamond shape with a diagonal line from top-left to bottom-right, and a solid black square below it.
park vehicle	The signwriting for 'park vehicle' consists of a diamond shape with a diagonal line from top-left to bottom-right, a solid black square below it, and an asterisk to the left.
parking lot	The signwriting for 'parking lot' consists of a diamond shape with a diagonal line from top-left to bottom-right, a solid black square below it, two asterisks to the right, a hand with fingers spread below that, and a circular arrow below the hand.
parking space	The signwriting for 'parking space' consists of a diamond shape with a diagonal line from top-left to bottom-right, a solid black square below it, and two asterisks below the square.
parliamentary	The signwriting for 'parliamentary' consists of a diamond shape with a diagonal line from top-left to bottom-right, a solid black square below it, an asterisk to the right, a hand with fingers spread below that, and another asterisk to the left of the hand.
parole	The signwriting for 'parole' consists of a circle at the top, a diamond shape with a diagonal line from top-left to bottom-right below it, a solid black square below the diamond, and another diamond shape with a diagonal line from top-left to bottom-right to the right of the square.
parsonage	The signwriting for 'parsonage' consists of a diamond shape with a diagonal line from top-left to bottom-right, a solid black square below it, and two asterisks to the right. Below this is a horizontal arrangement of three diamond shapes with diagonal lines from top-left to bottom-right, each with a solid black square below it. The left and right diamonds have double-headed vertical arrows below them. A left-pointing arrow is between the first and second diamonds, and a right-pointing arrow is between the second and third diamonds.





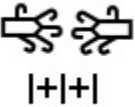
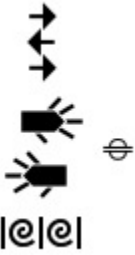
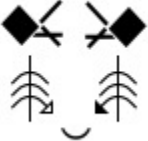

American Sign Language (ASL) Dictionary

Unedited 08082023

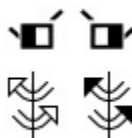
Spoken Word	SignWriting
part	
part	
partner	
partner	
partner	
party	
party	

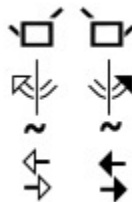
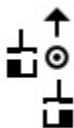

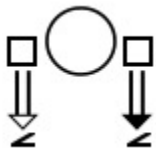

American Sign Language (ASL) Dictionary

Unedited 08082023

Spoken Word	SignWriting
party	
party	
party	
pass	
pass-by	
pass-by	
pass-complete	
passing-thru-eye	

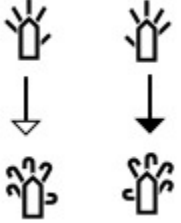
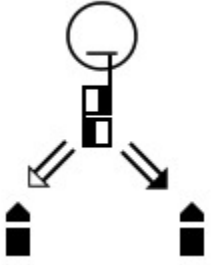
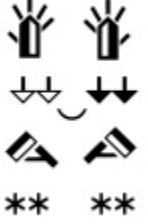

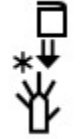





American Sign Language (ASL) Dictionary

Unedited 08082023

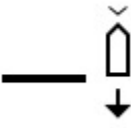
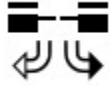
Spoken Word	SignWriting
passion	
passive	
passive	
Passover	
Passport	
passport	

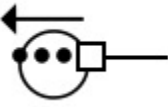
American Sign Language (ASL) Dictionary

Unedited 08082023

Spoken Word	SignWriting
password	
past	
past	
paste	
paste	
pasteurized-milk	
pasteurized-milk	
Pastor-Ron	
Pastor-Ron	





American Sign Language (ASL) Dictionary

Unedited 08082023

Spoken Word	SignWriting
pasturized-mild	
pasturized-milk	
pasturized-milk	
patch-on-arm	
path	
path-cl4mod	
path-cl4mod	
patience	



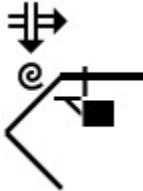
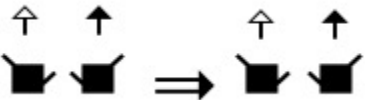

American Sign Language (ASL) Dictionary

Unedited 08082023

Spoken Word	SignWriting
patience	
patience	
Patience	
patient	
patient	
Patrick's "Trip"	
pattern	
patterned shirt	
Paul	

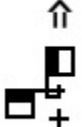
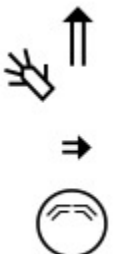
American Sign Language (ASL) Dictionary

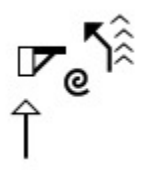
Unedited 08082023

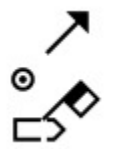
Spoken Word	SignWriting
pause	
pause 1	
pay	
pay	
Pay	
pay	
pay	
pay	







American Sign Language (ASL) Dictionary

Unedited 08082023

Spoken Word	SignWriting
pay	
Pay out	
payment	
pea	
Peace	
peace	
peace	







American Sign Language (ASL) Dictionary

Unedited 08082023

Spoken Word	SignWriting
peace	
peach	
peach	
peach	
peacock	
peacock	
peacock	

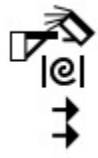



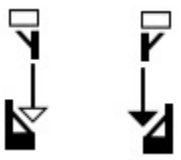
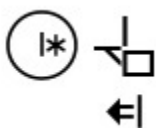

American Sign Language (ASL) Dictionary

Unedited 08082023

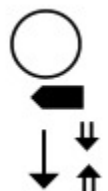
Spoken Word	SignWriting
peak	
peanut	
pear	
pear	
peas	
peas	
peculiar	
peddle	
pee	





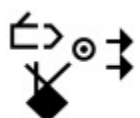



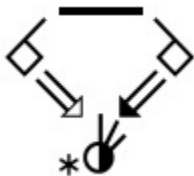

American Sign Language (ASL) Dictionary

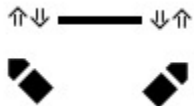
Unedited 08082023

Spoken Word	SignWriting
Peggy	
Pelican	
pen	
penalize	
pencil	
pencil	
pencil	
pencil	

American Sign Language (ASL) Dictionary

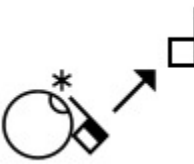
Unedited 08082023

Spoken Word	SignWriting
pendant	
penetrate	
penguin	
penis	
penitentiary	
Pennsylvania	
Pennsylvania	
Pennsylvania	
penny	
penny	







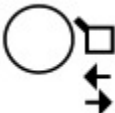

American Sign Language (ASL) Dictionary

Unedited 08082023

Spoken Word	SignWriting
pension	<p>The sign for 'pension' is written in two parts. The first part shows a square with a vertical line on the left, a horizontal line on the top, and a vertical line on the right, with a downward-pointing arrow below it. The second part shows a square with a vertical line on the left, a horizontal line on the top, and a vertical line on the right, with a downward-pointing arrow below it.</p>
people	<p>The sign for 'people' is written in two parts. The first part shows a square with a vertical line on the left, a horizontal line on the top, and a vertical line on the right, with a downward-pointing arrow below it. The second part shows a square with a vertical line on the left, a horizontal line on the top, and a vertical line on the right, with a downward-pointing arrow below it.</p>
people	<p>The sign for 'people' is written in two parts. The first part shows a square with a vertical line on the left, a horizontal line on the top, and a vertical line on the right, with a downward-pointing arrow below it. The second part shows a square with a vertical line on the left, a horizontal line on the top, and a vertical line on the right, with a downward-pointing arrow below it.</p>
people	<p>The sign for 'people' is written in two parts. The first part shows a square with a vertical line on the left, a horizontal line on the top, and a vertical line on the right, with a downward-pointing arrow below it. The second part shows a square with a vertical line on the left, a horizontal line on the top, and a vertical line on the right, with a downward-pointing arrow below it.</p>
people	<p>The sign for 'people' is written in two parts. The first part shows a square with a vertical line on the left, a horizontal line on the top, and a vertical line on the right, with a downward-pointing arrow below it. The second part shows a square with a vertical line on the left, a horizontal line on the top, and a vertical line on the right, with a downward-pointing arrow below it.</p>
people	<p>The sign for 'people' is written in two parts. The first part shows a square with a vertical line on the left, a horizontal line on the top, and a vertical line on the right, with a downward-pointing arrow below it. The second part shows a square with a vertical line on the left, a horizontal line on the top, and a vertical line on the right, with a downward-pointing arrow below it.</p>
people-onehanded	<p>The sign for 'people-onehanded' is written in two parts. The first part shows a square with a vertical line on the left, a horizontal line on the top, and a vertical line on the right, with a downward-pointing arrow below it. The second part shows a square with a vertical line on the left, a horizontal line on the top, and a vertical line on the right, with a downward-pointing arrow below it.</p>

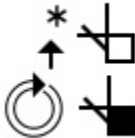





American Sign Language (ASL) Dictionary

Unedited 08082023

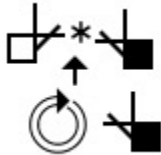
Spoken Word	SignWriting
pepper	
pepsi	
Pepsi	
percent	
percent	
perfect	
perfect	
perfect	
perfect	

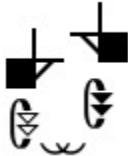







American Sign Language (ASL) Dictionary

Unedited 08082023

Spoken Word	SignWriting
perfect (3)	
perfect2	
perform	
perform	
perfume	
perhaps	
peril	
period	



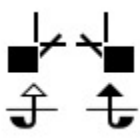



American Sign Language (ASL) Dictionary

Unedited 08082023

Spoken Word	SignWriting
period	
period	
period	
peripheral	
permanent	
permeable	
permit	
perpetual	



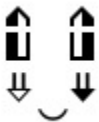

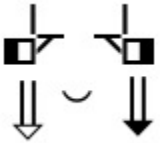
American Sign Language (ASL) Dictionary

Unedited 08082023

Spoken Word	SignWriting
perplex	
perplexed	
persecute	
persecute	
persist	
person	
person	
person	

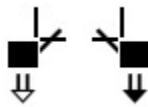
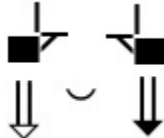

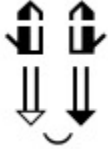

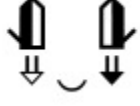
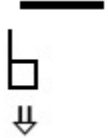
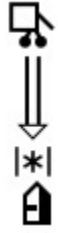
American Sign Language (ASL) Dictionary

Unedited 08082023

Spoken Word	SignWriting
person	
person	
person	
person	
person (2)	
person (3)	
person left hand	
person legs falling down on top of motorcycle	

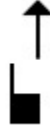

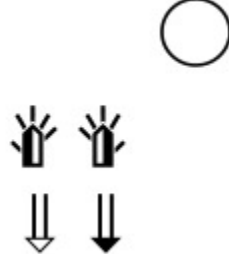
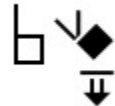
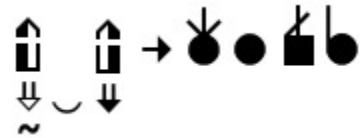



American Sign Language (ASL) Dictionary

Unedited 08082023

Spoken Word	SignWriting
person moves forward	
person moves forward - left hand	
person wanders	
person-left	
person-look	
person-word	
Personal Development	
personal space	

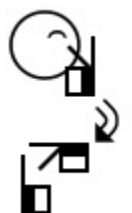

American Sign Language (ASL) Dictionary

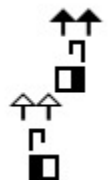
Unedited 08082023

Spoken Word	SignWriting
personality	
personality	
personality	
PersonalPuddle	
perspective	
perspective	
perspire	
persuade	



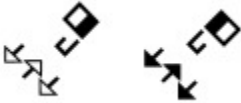





American Sign Language (ASL) Dictionary

Unedited 08082023

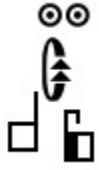
Spoken Word	SignWriting
persuade	
Peru	





American Sign Language (ASL) Dictionary

Unedited 08082023

Spoken Word	SignWriting
pescado	
pessimistic	
pest	
pet	
pet	
Peter	
Peter	
petition	

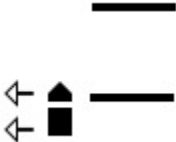
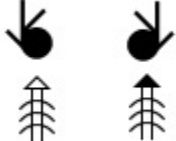

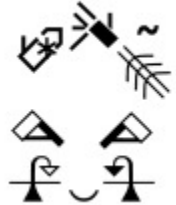
American Sign Language (ASL) Dictionary

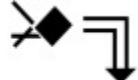
Unedited 08082023

Spoken Word	SignWriting
petrol	
petting a dog's head	
petty	
pharmacy	
pharmacy	
Philadelphia	
Philadelphia, Pennsylvania	



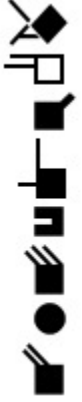
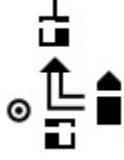
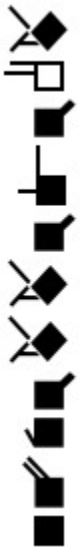



American Sign Language (ASL) Dictionary

Unedited 08082023

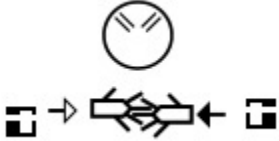
Spoken Word	SignWriting
Philemon	
Philip	
Philippians	
Philippines	
Philippines	

American Sign Language (ASL) Dictionary

Unedited 08082023

Spoken Word	SignWriting
Philosophy	
phobia	
Phoenix	
Phoenix	
phone	
phone	
phone	
phone	







American Sign Language (ASL) Dictionary

Unedited 08082023

Spoken Word	SignWriting
phonograph	
phonology	
phonology	
photocopy	
photograph	
photographer	
photography	
phrase	
phrase 1	





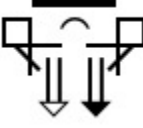
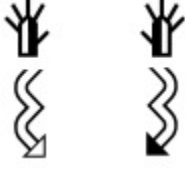

American Sign Language (ASL) Dictionary

Unedited 08082023

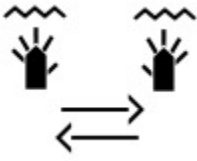
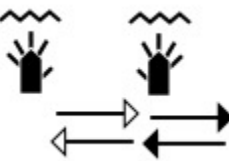
Spoken Word	SignWriting
phrase 2	
phrase close	
physical	
physical	
physical education	
physicist	
physics	
physiology	
physique	





American Sign Language (ASL) Dictionary

Unedited 08082023

Spoken Word	SignWriting
piano	
piano	
piano	
Picasso	
pick	
pick	
pick	

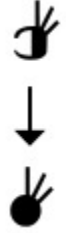

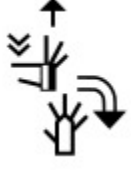
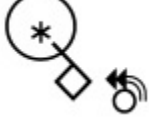



American Sign Language (ASL) Dictionary

Unedited 08082023

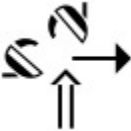
Spoken Word	SignWriting
pick	
pick	
pick on	
pick up box on right	
pick-from-list	
pick-nose	
pick-up	







American Sign Language (ASL) Dictionary

Unedited 08082023

Spoken Word	SignWriting
pick-up	
pick-up	
pick-up	
pick-up	
pick-up-to-the-left	
pickle	
pickle	

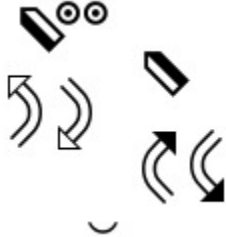





American Sign Language (ASL) Dictionary

Unedited 08082023

Spoken Word	SignWriting
pickle	
pickup-pieces	
picnic	
picture	
picture	
picture	

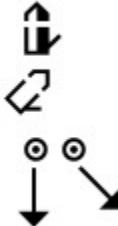



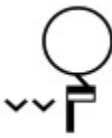



American Sign Language (ASL) Dictionary

Unedited 08082023

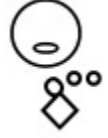
Spoken Word	SignWriting
picture	
pie	
pie	
pie	
pie	
pier	
pig	
pig	









American Sign Language (ASL) Dictionary

Unedited 08082023

Spoken Word	SignWriting
pilgrim	
pill	
pill	
pillow	
pilot	
pimple	
pin	
pinapple	

American Sign Language (ASL) Dictionary

Unedited 08082023

Spoken Word	SignWriting
pinapple	
pinapple	
pinch	
pineapple	
pink	
pioneer	
Pioneer	
PIOS 1.1	
PIOS 1.2	
pipe - tobacco - 1	









American Sign Language (ASL) Dictionary

Unedited 08082023

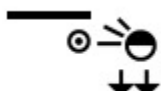
Spoken Word	SignWriting
pirate	 The SignWriting symbol for 'pirate' consists of a circle on the left. Inside the circle is a horizontal line with a small square at its right end. To the right of the circle is a hand icon with the index finger pointing left towards the circle.

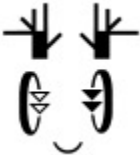

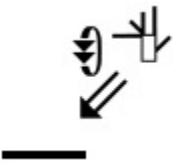

American Sign Language (ASL) Dictionary

Unedited 08082023

Spoken Word	SignWriting
pisac2	
piss	
pitcher	
Pittsburgh	
Pittsburgh, Pennsylvania	
pity	
pity	
pity	
pity	



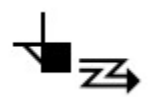

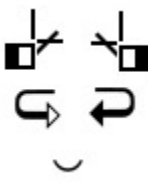
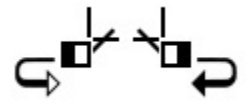
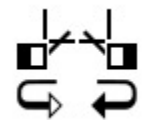

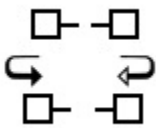

American Sign Language (ASL) Dictionary

Unedited 08082023

Spoken Word	SignWriting
pity	
pity	
pizza	
pizza	
pizza	
pizza maker	
place	
place	
place	

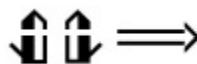

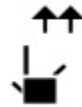



American Sign Language (ASL) Dictionary

Unedited 08082023

Spoken Word	SignWriting
Place - L:ocation	
plaid	
plain - ordinary	
plains land	
plan	
plan	
plan	
plan	
plane	
plane	





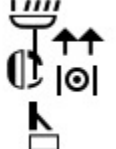

American Sign Language (ASL) Dictionary

Unedited 08082023

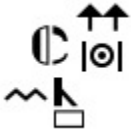
Spoken Word	SignWriting
planet	
planet	
planet	
planet	
plans	
plant	
plant	

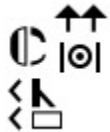
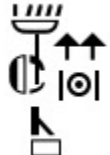
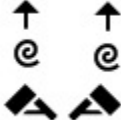
American Sign Language (ASL) Dictionary

Unedited 08082023

Spoken Word	SignWriting
plant	
plant	
plant	
plant	
planting seeds	
plastic	
plate	
plate	
platypus	







American Sign Language (ASL) Dictionary

Unedited 08082023

Spoken Word	SignWriting
play	
play	
play (on stage)	
play - fun	
play games	
play games	
player	

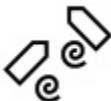
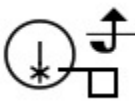





American Sign Language (ASL) Dictionary

Unedited 08082023

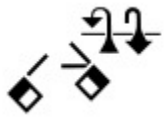
Spoken Word	SignWriting
plead	
pleasant	
please	
please	
please	
pledge	
plenty	
plow	



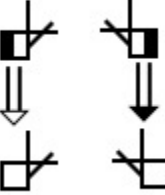
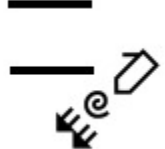



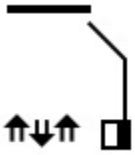

American Sign Language (ASL) Dictionary

Unedited 08082023

Spoken Word	SignWriting
plumber	
plumber	
plumbing	
plus	
pluto	
pneumonia	
pocket	
pocket	

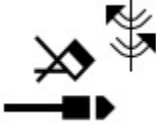

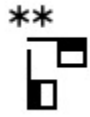





American Sign Language (ASL) Dictionary

Unedited 08082023

Spoken Word	SignWriting
pocketbook	
poem	
poetry	
poetry	
poetry	
point	
point	
point	



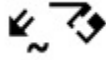
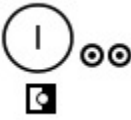

American Sign Language (ASL) Dictionary

Unedited 08082023

Spoken Word	SignWriting
point	
point to two	
point-feet-down	
point-left	
point-r-l	
point-right	
point-straight	
point-up-and-out	
poison	
poke	
Poland	

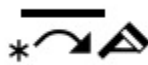
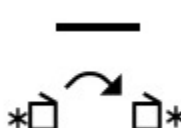
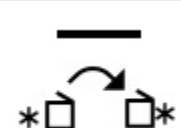
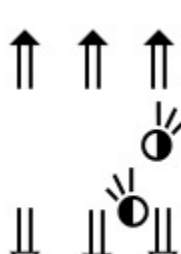

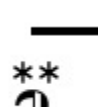

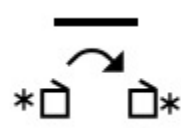
American Sign Language (ASL) Dictionary

Unedited 08082023

Spoken Word	SignWriting
Poland	
Poland	
Poland	
poles - construction	
police	
police	
police	
policy	
polish	







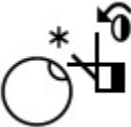

American Sign Language (ASL) Dictionary

Unedited 08082023

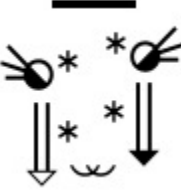
Spoken Word	SignWriting
Polish	
polite	
polite	
polite	
polite-left-hand	





American Sign Language (ASL) Dictionary

Unedited 08082023

Spoken Word	SignWriting
politics	
politics	
polka dot	
ponder	
ponder	
Pony Tail	
pool	
pool	
pooped	



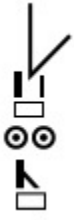

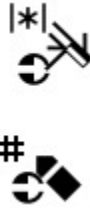

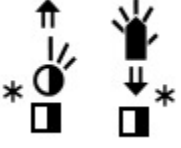

American Sign Language (ASL) Dictionary

Unedited 08082023

Spoken Word	SignWriting
poor	
poor	
poor	
pop	
pop	
pop	

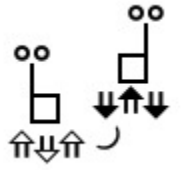







American Sign Language (ASL) Dictionary

Unedited 08082023

Spoken Word	SignWriting
Pop - Soda	
pop-up	
pop-up	
Pop-up	
popcorn	
Popcorn	
popular	
popular	





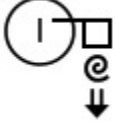



American Sign Language (ASL) Dictionary

Unedited 08082023

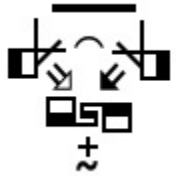
Spoken Word	SignWriting
popular	
porcelain	
porcupine	
portfolio	
Portland	
Portland	
portray	
Portugal	
Portugal	

American Sign Language (ASL) Dictionary

Unedited 08082023

Spoken Word	SignWriting
Portugal	
Portugal	
Portuguese	
positive	
positive	
positive with expression	
possibilities	
possibility	

American Sign Language (ASL) Dictionary

Unedited 08082023

Spoken Word	SignWriting
possibility	
possible	
possible	
possum	
post	
post-office	
postage	
poster	





American Sign Language (ASL) Dictionary

Unedited 08082023

Spoken Word	SignWriting
poster	
postman	
postpone	
postpone	
potato	
potato	
potato	
potato	

American Sign Language (ASL) Dictionary

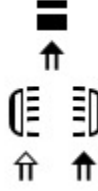
Unedited 08082023

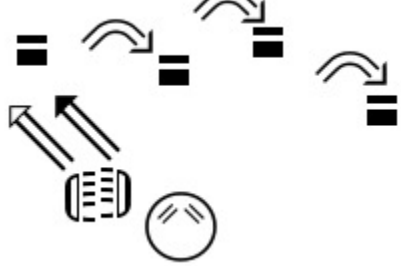
Spoken Word	SignWriting
pothead	
Pottery	
pottery barn	
pottery barn	
pottery-barn	







American Sign Language (ASL) Dictionary

Unedited 08082023

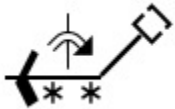
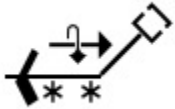
Spoken Word	SignWriting
pounce	<p>The SignWriting for 'pounce' consists of a circle with a horizontal line through its center, positioned above a series of arrows and a diamond shape. The arrows point downwards and to the right, with a diamond shape at the end of the path.</p>
pour	<p>The SignWriting for 'pour' shows a diamond shape with an arrow pointing downwards and to the right, ending in a curved arrow that loops back to the right.</p>
pour	<p>The SignWriting for 'pour' features a diamond shape with an arrow pointing downwards and to the right, ending in a curved arrow that loops back to the right. A small circle with a horizontal line through its center is positioned to the left of the diamond.</p>
pour	<p>The SignWriting for 'pour' shows a diamond shape with an arrow pointing downwards and to the right, ending in a curved arrow that loops back to the right.</p>
pour-money-into	<p>The SignWriting for 'pour-money-into' is a complex sequence of symbols. It includes a circle with a star inside, a diamond shape, and several arrows pointing in various directions, including upwards and to the right.</p>
poverty	<p>The SignWriting for 'poverty' consists of a diamond shape with an arrow pointing downwards and to the right, ending in a curved arrow that loops back to the right. A small circle with a horizontal line through its center is positioned to the left of the diamond.</p>
power	<p>The SignWriting for 'power' shows a diamond shape with an arrow pointing downwards and to the right, ending in a curved arrow that loops back to the right. A small circle with a horizontal line through its center is positioned to the left of the diamond.</p>

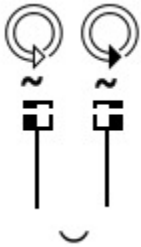



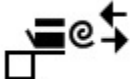
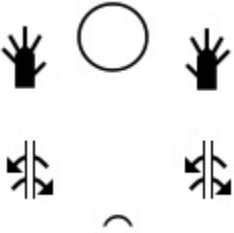

American Sign Language (ASL) Dictionary

Unedited 08082023

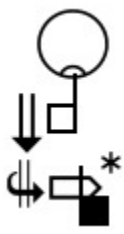
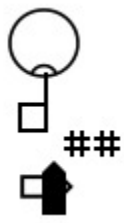
Spoken Word	SignWriting
power	
power	
power	
powerful	
PPP	
practice	
practice	
practice	
Praise	

American Sign Language (ASL) Dictionary

Unedited 08082023

Spoken Word	SignWriting
Praise	
Praise	
praise	
praise	
praise	
praise	
praise (2)	





American Sign Language (ASL) Dictionary

Unedited 08082023

Spoken Word	SignWriting
praise (2)	
pray	
pray	
pray	
pray	
pray to God	
Prayer Mat	

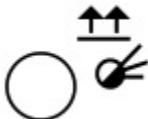

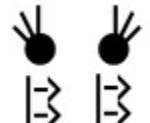

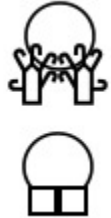

American Sign Language (ASL) Dictionary

Unedited 08082023

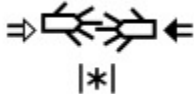
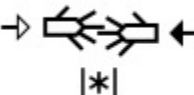
Spoken Word	SignWriting
preach	
preach	
preaching	
precede	
precious	
PRECIOUS-CHILD1	
PRECIOUS-CHILD2	
PRECIOUS-CHILD3	
PRECIOUS-CHILD4	

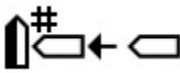
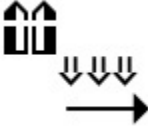





American Sign Language (ASL) Dictionary

Unedited 08082023

Spoken Word	SignWriting
PRECIOUS-CHILD5	
pregnant	
pregnant	
pregnant	
prejudice	
prepare	
Presbyterian	
prescription	
preserve	
preserve	









American Sign Language (ASL) Dictionary

Unedited 08082023

Spoken Word	SignWriting
president	
president	
president	
President	
pressure	
pretend	
pretty	







American Sign Language (ASL) Dictionary

Unedited 08082023

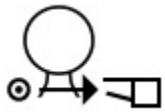
Spoken Word	SignWriting
pretty	
pretty	
pretty	
pretty	
pretty	
previous	
price	
pride	

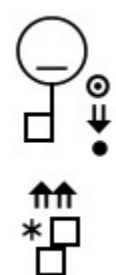





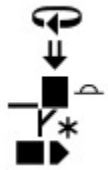

American Sign Language (ASL) Dictionary

Unedited 08082023

Spoken Word	SignWriting
pride	
priest	
priest	
priest	
Primerica	
prince	
prince	
princess	
Princess	





American Sign Language (ASL) Dictionary

Unedited 08082023

Spoken Word	SignWriting
principal	
principal	
principal	
principle	
print	
print	
print	
priority	
priority	

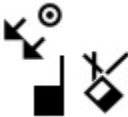
American Sign Language (ASL) Dictionary

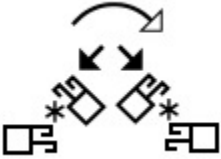
Unedited 08082023

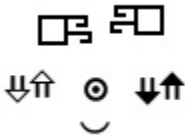
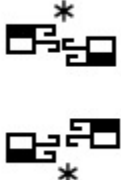
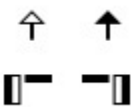
Spoken Word	SignWriting
priority	
prison	
Privilege	
prize	
problem	
problem	
problem	
problem	
proceed	









American Sign Language (ASL) Dictionary

Unedited 08082023

Spoken Word	SignWriting
proceed	
process	
procrastinating	
produce	
productivity	
Productivity	

American Sign Language (ASL) Dictionary

Unedited 08082023

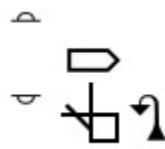
Spoken Word	SignWriting
professional	
professional	
profit	
program	
program	
program	
program	
program	
program	



American Sign Language (ASL) Dictionary

Unedited 08082023

Spoken Word	SignWriting
programmer	
programmer	
progress	
progress	
progress	
project	
projector	





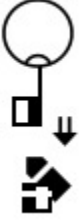

American Sign Language (ASL) Dictionary

Unedited 08082023

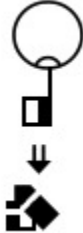
Spoken Word	SignWriting
projector	 <p>The SignWriting for 'projector' consists of a vertical sequence of symbols: a diamond with a diagonal line, a square with a diagonal line, a solid circle, a hand with fingers spread, the letters 'P', 'R', 'O', 'J', 'E', 'C', 'T', 'O', 'R', a solid circle, and a hand with fingers spread.</p>
prominent	 <p>The SignWriting for 'prominent' consists of a hand with fingers spread pointing up, positioned above a rectangular box.</p>
promise	 <p>The SignWriting for 'promise' consists of a vertical sequence of symbols: a circle with a hand inside, a square with an asterisk, a square with a diagonal line, a circle with a tilde symbol, and a hand with fingers spread pointing up with an asterisk.</p>
promise	 <p>The SignWriting for 'promise' consists of a vertical sequence of symbols: a circle with a hand inside, a square with a diagonal line, and a hand with fingers spread pointing up.</p>

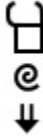

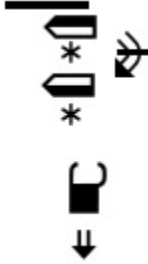

American Sign Language (ASL) Dictionary

Unedited 08082023

Spoken Word	SignWriting
promise	
pronoun	
pronoun	
pronoun	
pronoun	
pronoun	
pronoun	
pronoun	



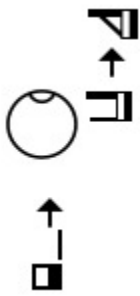
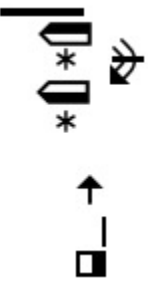



American Sign Language (ASL) Dictionary

Unedited 08082023

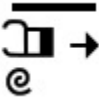
Spoken Word	SignWriting
pronoun	
pronoun	
pronoun	
pronoun	
pronoun feminine	
pronoun plural	
pronoun plural	

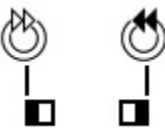

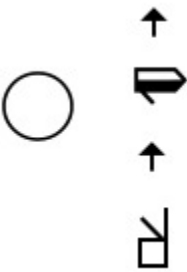
American Sign Language (ASL) Dictionary

Unedited 08082023

Spoken Word	SignWriting
pronoun plural	
pronoun plural	
proof	
propel	
proper	
prophecy	
prophecy	

American Sign Language (ASL) Dictionary

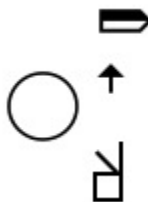
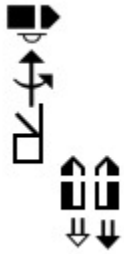
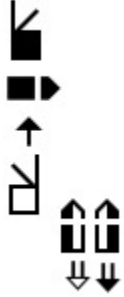
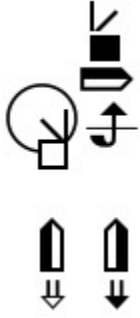
Unedited 08082023

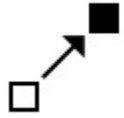
Spoken Word	SignWriting
prophecy	
prophet	
prophet	
prophet	
protection	
protest	







American Sign Language (ASL) Dictionary

Unedited 08082023

Spoken Word	SignWriting
proton	
proud	
proud--2	
prove	
Proverbs 3:27	
provide	
provide	







American Sign Language (ASL) Dictionary

Unedited 08082023

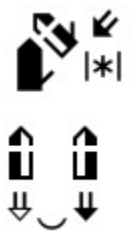
Spoken Word	SignWriting
provide	
Psalm	
Psalm91v01	
pshaw	
psychiatric	
Psychiatrist	
psychiatrist	
psychiatrist	

American Sign Language (ASL) Dictionary

Unedited 08082023

Spoken Word	SignWriting
psychologist	 <p>The SignWriting for 'psychologist' consists of two parts. The first part shows a hand with fingers curled, moving from the top right towards the center, with a vertical line and an asterisk to its right. The second part shows two hands, one above the other, both with fingers curled and moving downwards, with a curved arrow between them indicating a transition or connection.</p>
psychologist	 <p>The SignWriting for 'psychologist' consists of two parts. The first part shows a hand with fingers curled, moving from the top left towards the center, with a vertical line and an asterisk to its left, and an upward arrow below it. The second part shows a hand with fingers curled, moving from the top right towards the center, with a downward arrow below it.</p>
psychology	 <p>The SignWriting for 'psychology' consists of two parts. The first part shows a hand with fingers curled, moving from the top left towards the center, with a vertical line and two asterisks to its right. The second part shows a hand with fingers curled, moving from the top right towards the center.</p>
psychology	 <p>The SignWriting for 'psychology' consists of two parts. The first part shows a hand with fingers curled, moving from the top left towards the center, with a vertical line and two asterisks to its right. The second part shows a hand with fingers curled, moving from the top right towards the center.</p>
psychology	 <p>The SignWriting for 'psychology' consists of two parts. The first part shows a hand with fingers curled, moving from the top left towards the center, with a vertical line and two asterisks to its right. The second part shows a hand with fingers curled, moving from the top right towards the center.</p>
psychology	 <p>The SignWriting for 'psychology' consists of two parts. The first part shows a hand with fingers curled, moving from the top left towards the center, with a vertical line and two asterisks to its right. The second part shows a hand with fingers curled, moving from the top right towards the center.</p>
psychology	 <p>The SignWriting for 'psychology' consists of two parts. The first part shows a hand with fingers curled, moving from the top left towards the center, with a vertical line and two asterisks to its right. The second part shows a hand with fingers curled, moving from the top right towards the center.</p>
Public	







American Sign Language (ASL) Dictionary

Unedited 08082023

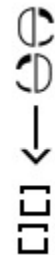
Spoken Word	SignWriting
public	The SignWriting symbol for 'public' consists of a circle containing an asterisk, with a square to its right and a small circle below it.
publicize	The SignWriting symbol for 'publicize' features two squares, one above the other, with two arrows pointing from the top square to the bottom one. Below the squares are two hash symbols (#).
publish	The SignWriting symbol for 'publish' shows a square with a checkmark inside, and another square below it with a checkmark pointing towards it.
puddle	The SignWriting symbol for 'puddle' consists of two circles, one to the left of the other, with a tilde (~) between them.
Puerto Rico	The SignWriting symbol for 'Puerto Rico' includes a square with a vertical line through it, a diamond below it, and a small square above the diamond.
Puerto Rico	The SignWriting symbol for 'Puerto Rico' shows two squares, one above the other, with a checkmark pointing from the top square to the bottom one.
Puerto Rico	The SignWriting symbol for 'Puerto Rico' features a circle with a hand inside, and three arrows pointing downwards from the bottom of the circle.
pull	The SignWriting symbol for 'pull' shows two squares, one to the left of the other, with arrows pointing from the right square towards the left square.

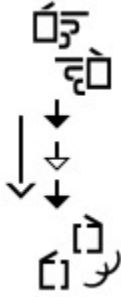





American Sign Language (ASL) Dictionary

Unedited 08082023

Spoken Word	SignWriting
pull	
pulling thread off a weaving machine	
pulling thread off a weaving machine	
pump	
punch	
punch-in-face	
punctuation - period	

American Sign Language (ASL) Dictionary

Unedited 08082023

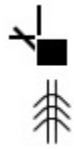
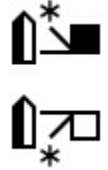
Spoken Word	SignWriting
punish	
punish	
puppet	
purple	
purple	
purple	
purple	
purpose	







American Sign Language (ASL) Dictionary

Unedited 08082023

Spoken Word	SignWriting
push	
push aside	
push aside	
push object back to left	
push-aside	
push-down	
pushpin	
put	

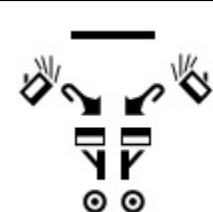



American Sign Language (ASL) Dictionary

Unedited 08082023

Spoken Word	SignWriting
put down roots	
put down rounded object abruptly	
put into heart	
put on mind	
put-down	
put-down	
put-in-me	

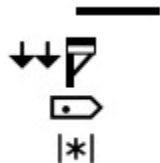
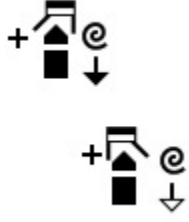
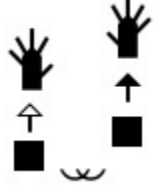

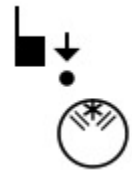
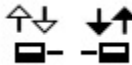





American Sign Language (ASL) Dictionary

Unedited 08082023

Spoken Word	SignWriting
PUT-INSIDE-MY-HEART	
put-on-shoes	
putting away	
puzzle	
puzzle	
puzzled	
puzzles	
Pyramid	

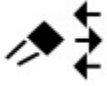
American Sign Language (ASL) Dictionary

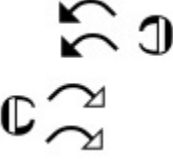
Unedited 08082023

Spoken Word	SignWriting
Q	
Q-receptive	
qadosh	
quaint	
queen	
queen	
queen	
queer	
quest	
question	

American Sign Language (ASL) Dictionary

Unedited 08082023

Spoken Word	SignWriting
question	
question	
question	
Question-maker NMS	
QUESTIONING	
quick	
quick	
quick	
quit	

American Sign Language (ASL) Dictionary

Unedited 08082023

Spoken Word	SignWriting
quitter	<p>The SignWriting for 'quitter' consists of two vertical double-headed arrows on the left and right sides. In the center, there is a hand symbol with a diamond shape and an asterisk below it, with two diagonal arrows pointing upwards and outwards.</p>
quote	<p>The SignWriting for 'quote' shows two hand symbols. Each hand has a diamond shape and a vertical double-headed arrow. A curved arrow above the hands indicates a transition or movement between the two hand positions.</p>
quote	<p>The SignWriting for 'quote' shows two hand symbols. Each hand has a diamond shape and a vertical double-headed arrow. A curved arrow above the hands indicates a transition or movement between the two hand positions.</p>
quote	<p>The SignWriting for 'quote' shows two hand symbols. Each hand has a diamond shape and a vertical double-headed arrow. A curved arrow above the hands indicates a transition or movement between the two hand positions.</p>
quote	<p>The SignWriting for 'quote' features a smiling face symbol at the top. Below it are two hand symbols, each with a diamond shape and a vertical double-headed arrow. A curved arrow below the hands indicates a transition or movement between the two hand positions.</p>
quote from	<p>The SignWriting for 'quote from' is rotated 45 degrees clockwise. It features a smiling face symbol at the top, followed by two hand symbols with diamond shapes and vertical double-headed arrows. A curved arrow below the hands indicates a transition or movement between the two hand positions.</p>







American Sign Language (ASL) Dictionary

Unedited 08082023

Spoken Word	SignWriting
quote title	<p>The signwriting consists of a circle with two horizontal lines inside, representing a quote. Below it are two hands, each with a vertical line and a horizontal line, representing the word 'title'.</p>
quotient	<p>The signwriting consists of a circle with a dot inside, representing a quotient. Below it are two hands, each with a vertical line and a horizontal line, representing the word 'quotient'.</p>
R	<p>The signwriting consists of a hand with a vertical line and a horizontal line, representing the letter 'R'.</p>
R-receptive	<p>The signwriting consists of a hand with a vertical line and a horizontal line, representing the letter 'R', and a hand with a vertical line and a horizontal line, representing the word 'receptive'.</p>
r-shake	<p>The signwriting consists of a hand with a vertical line and a horizontal line, representing the letter 'R', and a hand with a vertical line and a horizontal line, representing the word 'shake'.</p>
Rabbi	<p>The signwriting consists of two hands, each with a vertical line and a horizontal line, representing the word 'Rabbi'.</p>
rabbit	<p>The signwriting consists of two hands, each with a vertical line and a horizontal line, representing the word 'rabbit'.</p>
rabbit	<p>The signwriting consists of two hands, each with a vertical line and a horizontal line, representing the word 'rabbit'.</p>



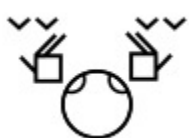

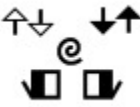

American Sign Language (ASL) Dictionary

Unedited 08082023

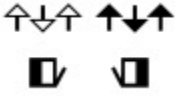
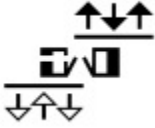
Spoken Word	SignWriting
rabbit	
rabbit	
rabbit	
rabbit	
rabbit	
rabbit	
rabbit	
raccoon	
race	

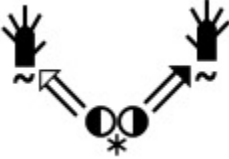
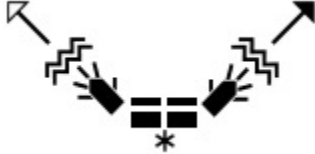





American Sign Language (ASL) Dictionary

Unedited 08082023

Spoken Word	SignWriting
race	
race	
RACOON	
radiant	
Radiation	
radio	
radioactive	
radish	
rage	

American Sign Language (ASL) Dictionary

Unedited 08082023

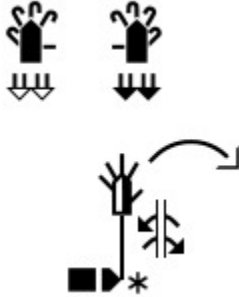
Spoken Word	SignWriting
railroad	
railroad crossing	
rain	
rain	
rain	
rain	
rain forest	





American Sign Language (ASL) Dictionary

Unedited 08082023

Spoken Word	SignWriting
rain forest	<p>The signwriting for 'rain forest' consists of two hand icons at the top, each with three downward-pointing arrows. Below them is a stylized tree with a vertical trunk and several horizontal branches. A curved arrow indicates a movement from the top right towards the tree. At the base of the trunk is a small asterisk.</p>
rain heavily	<p>The signwriting for 'rain heavily' features two hand icons at the top, each with three downward-pointing arrows. Below these is a circle containing two upward-pointing arrows.</p>
rainbow	<p>The signwriting for 'rainbow' shows a hand icon on the left with a curved arrow pointing upwards and to the right. A second hand icon is positioned further to the right, also with a curved arrow pointing upwards and to the right.</p>
rainbow	<p>The signwriting for 'rainbow' depicts a hand icon on the left with a curved arrow pointing upwards and to the right. A second hand icon is positioned further to the right, also with a curved arrow pointing upwards and to the right.</p>
raining	<p>The signwriting for 'raining' features two hand icons at the top, each with three downward-pointing arrows. Below these is a circle containing two upward-pointing arrows.</p>
raining diagonal	<p>The signwriting for 'raining diagonal' shows two hand icons at the top, each with three downward-pointing arrows. Below these is a circle containing two diagonal arrows pointing upwards and to the right.</p>
raise	<p>The signwriting for 'raise' consists of two hand icons at the bottom, each with three upward-pointing arrows.</p>

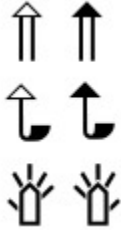



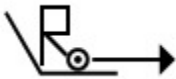

American Sign Language (ASL) Dictionary

Unedited 08082023

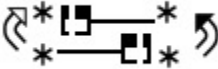
Spoken Word	SignWriting
raise	
raise-up	
raisin	
raking	
rally	
Ramadan	
rampart	



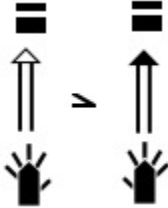

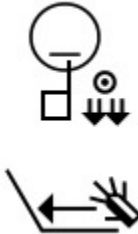



American Sign Language (ASL) Dictionary

Unedited 08082023

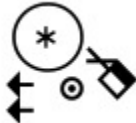
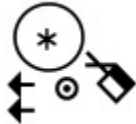
Spoken Word	SignWriting
ramparts	
ranch	
rank	
rapid	
rapture	
rare	
rascal	
rash	





American Sign Language (ASL) Dictionary

Unedited 08082023

Spoken Word	SignWriting
rash - medical	
rat	
rat	
rat	
rather	
rather - 2	
ratification	
rational	
rattle	



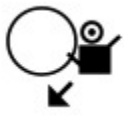
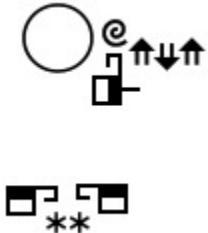
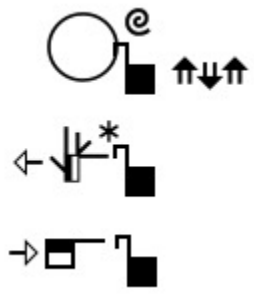

American Sign Language (ASL) Dictionary

Unedited 08082023

Spoken Word	SignWriting
ravenous	
rays of sun	
razor	
razor - electric	
razor blade	
reach-left	

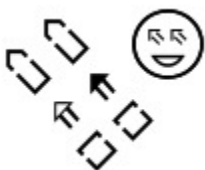

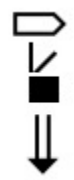

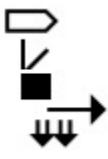
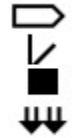
American Sign Language (ASL) Dictionary

Unedited 08082023

Spoken Word	SignWriting
reach-up-left	
reaction time	
read	
read	
read	
read	
read	

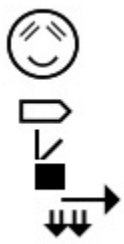
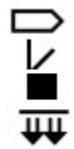

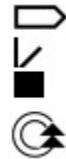

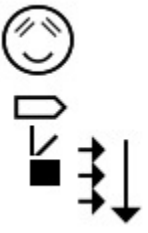
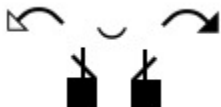



American Sign Language (ASL) Dictionary

Unedited 08082023

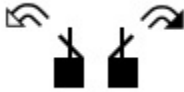
Spoken Word	SignWriting
read	
read	
read	
read	
read	
read	
read-horizontally	
ready	



American Sign Language (ASL) Dictionary

Unedited 08082023

Spoken Word	SignWriting
ready	
ready	
ready	
ready	
ready	
Reagan	
Real	
Real	
realize	
realize	
realize-q	





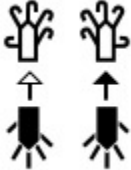

American Sign Language (ASL) Dictionary

Unedited 08082023

Spoken Word	SignWriting
really	
really	
reap	
rear car damage	

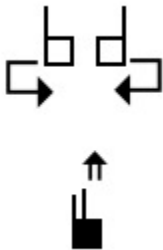

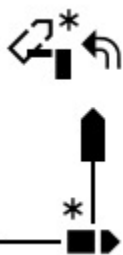

American Sign Language (ASL) Dictionary

Unedited 08082023

Spoken Word	SignWriting
rear dent	
rear end collision	
Rear view mirror	
rearranged	
Reason	
reason	
reason	
reassure	

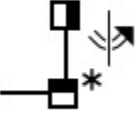

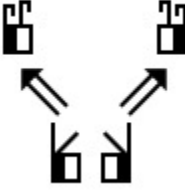

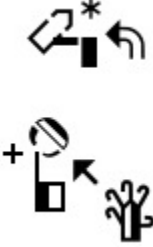
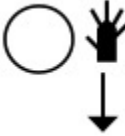
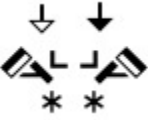

American Sign Language (ASL) Dictionary

Unedited 08082023

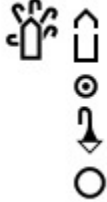
Spoken Word	SignWriting
rebel - verb	
rebirth	
rebound	
rebuke	
recapture	
recede	
receive	

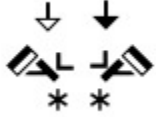
American Sign Language (ASL) Dictionary

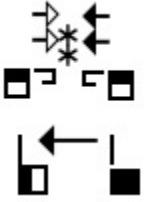
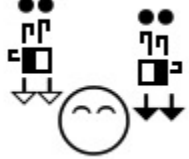
Unedited 08082023

Spoken Word	SignWriting
Receive money	
receive-2	
received	
recently	
receptacle	
receptive	
receptive viewpoint	
reckless	
recline	





American Sign Language (ASL) Dictionary

Unedited 08082023

Spoken Word	SignWriting
recluse	<p>The signwriting for 'recluse' consists of a sequence of four symbols: a hand with fingers spread pointing right, a square, a hand with fingers spread pointing right, and an upward-pointing arrow.</p>
recognize	<p>The signwriting for 'recognize' consists of a sequence of symbols: a circle, a hand with fingers spread pointing right, a square, a hand with fingers spread pointing right, a square, and an asterisk.</p>
recoil	<p>The signwriting for 'recoil' consists of a sequence of symbols: two hands with fingers spread pointing up, a double arrow pointing up and to the right, and two hands with fingers spread pointing up.</p>
recollection	<p>The signwriting for 'recollection' consists of a sequence of symbols: a hand with fingers spread pointing up, a hand with fingers spread pointing up, and a circular arrow pointing clockwise.</p>
recommend	<p>The signwriting for 'recommend' consists of a sequence of symbols: a hand with fingers spread pointing up, a hand with fingers spread pointing up, and a hand with fingers spread pointing up.</p>
record	<p>The signwriting for 'record' consists of a sequence of symbols: a hand with fingers spread pointing up, a hand with fingers spread pointing up, and a hand with fingers spread pointing up.</p>
record	<p>The signwriting for 'record' consists of a sequence of symbols: a hand with fingers spread pointing up, a hand with fingers spread pointing up, and two asterisks.</p>





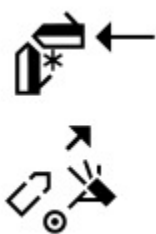
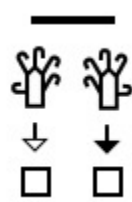
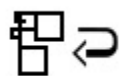

American Sign Language (ASL) Dictionary

Unedited 08082023

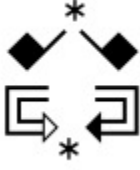
Spoken Word	SignWriting
record	
record	
record - noun	
record making	
recount	
recover	
recruit - solicit	

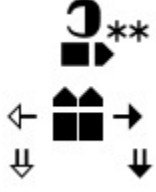
American Sign Language (ASL) Dictionary

Unedited 08082023

Spoken Word	SignWriting
rectangle	
rectangular prism	
rectory	
red	
red	
red	
red	



American Sign Language (ASL) Dictionary

Unedited 08082023

Spoken Word	SignWriting
red light	<p>The signwriting for 'red light' consists of a circle with a horizontal line through its center. Below the line is a square with a dot in its center. An arrow points from the square down to a smaller dot. Below this dot is a diamond shape with a vertical line through its center. Below the diamond is a hand symbol with fingers spread, and an arrow points from the diamond down to the hand.</p>
red pepper	<p>The signwriting for 'red pepper' consists of a circle with a horizontal line through its center. Below the line is a diamond shape with a vertical line through its center. An arrow points from the diamond down to a smaller diamond. Below this diamond is a star symbol. Below the star is a sequence of four diamond shapes with vertical lines through their centers, followed by a hand symbol with fingers spread.</p>
rediculous	<p>The signwriting for 'rediculous' consists of a diamond shape with a vertical line through its center. An arrow points from the diamond down to a smaller diamond. Below this diamond is a circle with a horizontal line through its center. Below the circle is another diamond shape with a vertical line through its center.</p>
reduce	<p>The signwriting for 'reduce' consists of a diamond shape with a vertical line through its center. An arrow points from the diamond down to a smaller diamond. Below this diamond is a hand symbol with fingers spread.</p>
referee	<p>The signwriting for 'referee' consists of a circle with a horizontal line through its center. Below the line is a diamond shape with a vertical line through its center. An arrow points from the diamond down to a smaller diamond. Below this diamond are two asterisks (**).</p>
reflect God's glory	<p>The signwriting for 'reflect God's glory' consists of a hand symbol with fingers spread. An arrow points from the hand down to a diamond shape with a vertical line through its center. Below the diamond is another diamond shape with a vertical line through its center. An arrow points from the second diamond down to a third diamond shape with a vertical line through its center. Below the third diamond is a star symbol.</p>



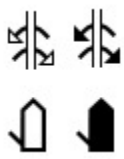
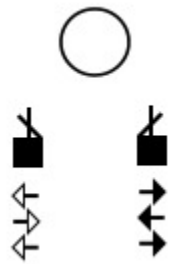
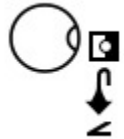
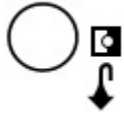

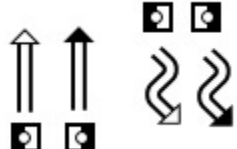

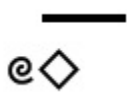

American Sign Language (ASL) Dictionary

Unedited 08082023

Spoken Word	SignWriting
reflection	
refrigerate	
refuse	
refuse	
Register	
registration	
regress	

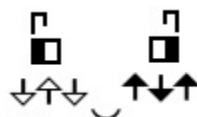







American Sign Language (ASL) Dictionary

Unedited 08082023

Spoken Word	SignWriting
regret	
regular	
regular	
rehabilitate	
rehearsal	
reign	
reindeer	
reinforce	
reiterate	



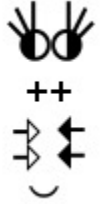





American Sign Language (ASL) Dictionary

Unedited 08082023

Spoken Word	SignWriting
reject	
reject	
rejoice	
relate	
relate	
relate	
relate	
relate	

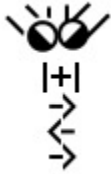

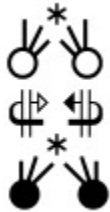



American Sign Language (ASL) Dictionary

Unedited 08082023

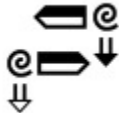
Spoken Word	SignWriting
relate	
relate	
relate-upL	
related	
Relationship	
relationship	
relative	
relatives	

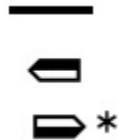

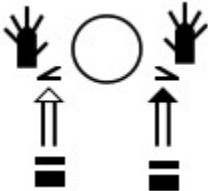

American Sign Language (ASL) Dictionary

Unedited 08082023

Spoken Word	SignWriting
relax	
relay-call	
relieve	
relieved	
relieved	
religion	
relinquish	
rely	
remainder	

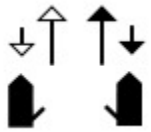
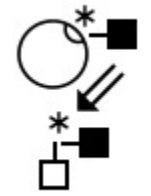
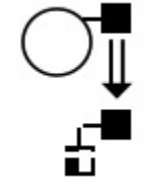
American Sign Language (ASL) Dictionary

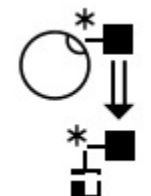
Unedited 08082023

Spoken Word	SignWriting
remaining	
remarkable	
remember	
remember	
remember	
remember	
remember	







American Sign Language (ASL) Dictionary

Unedited 08082023

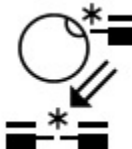
Spoken Word	SignWriting
remember	



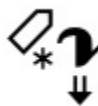
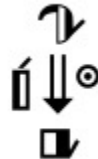



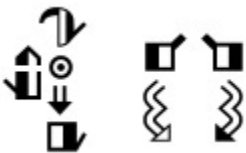

American Sign Language (ASL) Dictionary

Unedited 08082023

Spoken Word	SignWriting
remember	
remember	
remind	
Reminder	
reminder	
reminisce	
remove	
remove	
remove	



American Sign Language (ASL) Dictionary

Unedited 08082023

Spoken Word	SignWriting
remove image	
remove tonsils	
remove-eye	
remove-eyes	
rent	
repeat	
repeat-to	
repeated-mischief	

American Sign Language (ASL) Dictionary

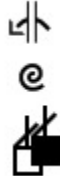
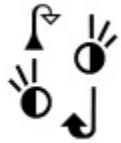
Unedited 08082023

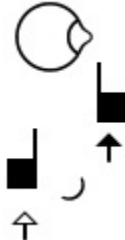
Spoken Word	SignWriting
repent	
repent	
replace	
reply	
report	
report	







American Sign Language (ASL) Dictionary

Unedited 08082023

Spoken Word	SignWriting
report card	<p>The SignWriting for 'report card' (first entry) consists of two columns of signs. The left column has three signs: a square with a downward arrow, a square with a downward arrow, and a square with a downward arrow. The right column has three signs: a square with a downward arrow, a square with a downward arrow, and a square with a downward arrow. Below these columns is a separate sign: a square with a rightward arrow.</p>
report card	<p>The SignWriting for 'report card' (second entry) consists of a top section with three signs: a square with a downward arrow, a square with a downward arrow, and a square with a downward arrow. Below this is a sign: a square with a rightward arrow. At the bottom are two signs: a square with a leftward arrow and a square with a rightward arrow.</p>
reporter	<p>The SignWriting for 'reporter' consists of a top sign: a square with a downward arrow. Below it are two signs: a square with a downward arrow and a square with a downward arrow. At the bottom are two signs: a square with a leftward arrow and a square with a rightward arrow.</p>
reporter	<p>The SignWriting for 'reporter' (second entry) consists of a top sign: a square with a downward arrow. Below it are two signs: a square with a downward arrow and a square with a downward arrow. At the bottom are two signs: a square with a leftward arrow and a square with a rightward arrow.</p>
represent	<p>The SignWriting for 'represent' consists of a top sign: a square with a downward arrow. Below it are two signs: a square with a downward arrow and a square with a downward arrow.</p>

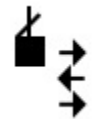

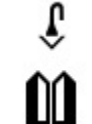





American Sign Language (ASL) Dictionary

Unedited 08082023

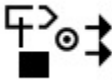
Spoken Word	SignWriting
representative	 
reproduction	
Republican	
reputation	
request	
request	
require	







American Sign Language (ASL) Dictionary

Unedited 08082023

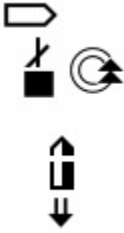
Spoken Word	SignWriting
requirements	
research	
research	
research	
research	
research	
research	
research	



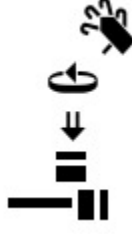

American Sign Language (ASL) Dictionary

Unedited 08082023

Spoken Word	SignWriting
researcher	
researcher	
researcher	
researcher	
Resent	
reserve	
resist	

American Sign Language (ASL) Dictionary

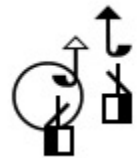
Unedited 08082023

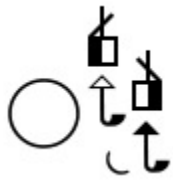
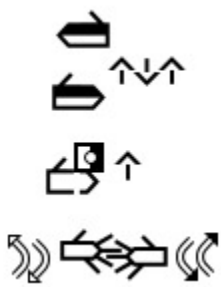
Spoken Word	SignWriting
resist	
resolution	
respec-2	
respect	
respect-2	
respirator	







American Sign Language (ASL) Dictionary

Unedited 08082023

Spoken Word	SignWriting
response	<p>The SignWriting symbol for 'response' consists of a circle with a horizontal line through its center. Below the circle are two vertical lines, each topped with a wavy line. At the bottom are two upward-pointing arrows, with a small curved line to the right of the right arrow.</p>
responsible	<p>The SignWriting symbol for 'responsible' features a horizontal line on the left. To its right are two vertical lines, each with a wavy line at the top. Below these are two downward-pointing arrows, with a small curved line to the right of the right arrow.</p>
responsible	<p>The SignWriting symbol for 'responsible' shows a horizontal line on the left. To its right are two vertical lines, each with a square at the top. Below these are two downward-pointing arrows, with two asterisks to the right of the right arrow.</p>
responsible	<p>The SignWriting symbol for 'responsible' includes a horizontal line on the left. To its right are two vertical lines, each with a square at the top. Below these are two downward-pointing arrows, with two asterisks to the right of the right arrow.</p>
responsiveness	<p>The SignWriting symbol for 'responsiveness' depicts two vertical lines, each with a square at the top. Below these are two downward-pointing arrows, with a double-lined arrow pointing downwards between them.</p>
Rest	
rest	<p>The SignWriting symbol for 'rest' shows a circle with a horizontal line through its center. Below the circle are two vertical lines, each topped with a wavy line. At the bottom are two downward-pointing arrows, with two asterisks to the right of the right arrow.</p>
rest	<p>The SignWriting symbol for 'rest' features a horizontal line on the left. To its right are two vertical lines, each with a square at the top. Below these are two downward-pointing arrows, with two asterisks to the right of the right arrow.</p>



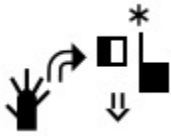
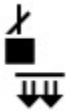

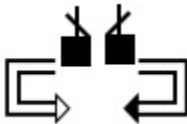
American Sign Language (ASL) Dictionary

Unedited 08082023

Spoken Word	SignWriting
restaurant	
restaurant	
restaurant	
resting	
restrain	
restroom	
result	
resume	

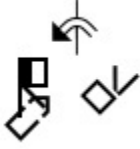
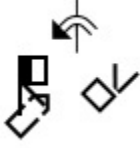
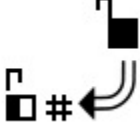



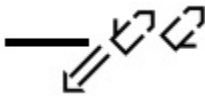

American Sign Language (ASL) Dictionary

Unedited 08082023

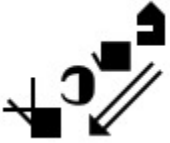
Spoken Word	SignWriting
resurrect	
Resurrection	
retaliate	
retard	
retire	
retirement	
retrospect	
return	



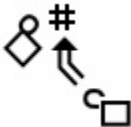

American Sign Language (ASL) Dictionary

Unedited 08082023

Spoken Word	SignWriting
return	
reveal	
reveal	
Revelation	
revenge	
reverberate	
reverse	

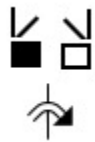
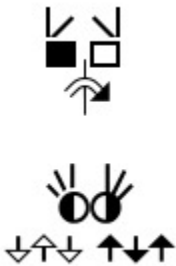
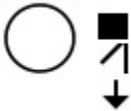

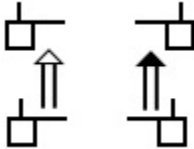

American Sign Language (ASL) Dictionary

Unedited 08082023

Spoken Word	SignWriting
reverse	
reverse interpet	
review	
review	
review	
revive	
revolt--rebellion	
revolt--rebellion	

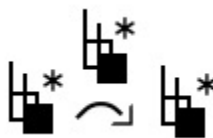





American Sign Language (ASL) Dictionary

Unedited 08082023

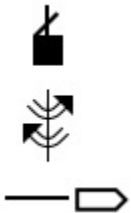
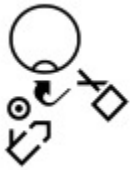
Spoken Word	SignWriting
RG meet	
rhinoceros	
Rhode Island	
Rhode-Island	
rhombus	

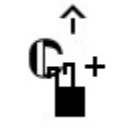
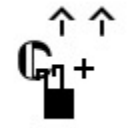

American Sign Language (ASL) Dictionary

Unedited 08082023

Spoken Word	SignWriting
rhyme	
rice	
Rich	
ride	
ride	
ride	
ride	
ride a bike	

American Sign Language (ASL) Dictionary

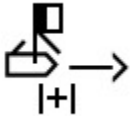
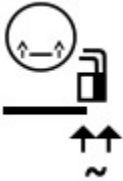
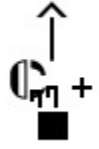
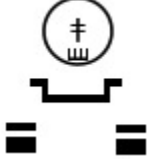
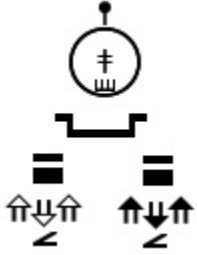
Unedited 08082023

Spoken Word	SignWriting
ride a horse	
ride a horse	
ride for a while	
ride in vehicle	
ride motorcycle angrily	
ride motorcycle fast on bumpy road	
ride over a hill	









American Sign Language (ASL) Dictionary

Unedited 08082023

Spoken Word	SignWriting
ride quickly over bumpy road	
ride rollercoaster	
rifle	
right	
right	
right	
Right	
right	
right (direction)	

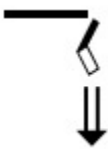





American Sign Language (ASL) Dictionary

Unedited 08082023

Spoken Word	SignWriting
right flip	
right hand facing left	
right here	
right on	
right side of body	
right turn	
righteous	
righteous	







American Sign Language (ASL) Dictionary

Unedited 08082023

Spoken Word	SignWriting
righteous	
righteous	
righteousness	
righteousness	
righteousness	
righteousness	

American Sign Language (ASL) Dictionary

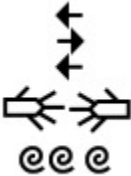
Unedited 08082023

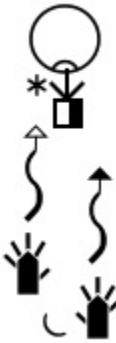
Spoken Word	SignWriting
ring	
ring	
ring	
rinse	
riot	
rip	
river	

American Sign Language (ASL) Dictionary

Unedited 08082023

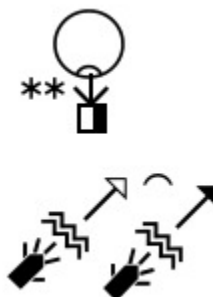
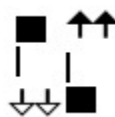
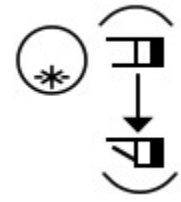
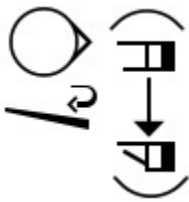
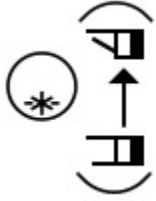
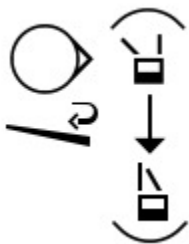
Spoken Word	SignWriting
river	
road	
road disappearing in the distance behind	
road disappearing in the distance behind	
road disappearing in the distance front	
road disappearing in the distance, behind	

American Sign Language (ASL) Dictionary

Unedited 08082023

Spoken Word	SignWriting
road disappearing in the distance, front	<p>The signwriting consists of a circle with an asterisk on the left. To its right is a vertical line with a square at the top and bottom, and an upward-pointing arrow in the center. This vertical line is enclosed in a large, thin-lined circle.</p>
road whizzing by under vehicle	<p>The signwriting consists of a circle with a wavy line inside, representing a road. Below this are two hands in a 'V' shape, representing a vehicle, with a wavy line underneath them representing the road passing by.</p>
road whizzing by under vehicle intensely fast	<p>The signwriting consists of a circle with a cross inside, representing a road. Below this is a hand in a 'V' shape, representing a vehicle, with a wavy line underneath them representing the road passing by.</p>
Roadrunner	<p>The signwriting consists of a circle with an asterisk on the left. To its right is a hand in a 'V' shape, representing a roadrunner, with a wavy line underneath them representing the road.</p>

American Sign Language (ASL) Dictionary

Unedited 08082023

Spoken Word	SignWriting
roadrunner	<p>The SignWriting for 'roadrunner' consists of a vertical sequence of 12 symbols: a hand with fingers spread, a square, a circle, a square, a circle, a square, a square, a square, a square, a square, a square, and a hand with fingers spread.</p>
Roadrunner accelerates classifier mouth open	<p>The SignWriting for 'Roadrunner accelerates classifier mouth open' includes: a classifier for acceleration (a circle with an upward arrow), a classifier for an open mouth (a circle with an upward arrow), a classifier for a hand (a hand with fingers spread), and a classifier for a hand (a hand with fingers spread).</p>
Roadrunner character looks left, sticks tongue out	<p>The SignWriting for 'Roadrunner character looks left, sticks tongue out' includes: a classifier for looking left (a circle with a leftward arrow), a classifier for sticking tongue out (a horizontal line), and a classifier for a hand (a hand with fingers spread).</p>
Roadrunner character stops, looks left	<p>The SignWriting for 'Roadrunner character stops, looks left' includes: a classifier for looking left (a circle with a leftward arrow), a classifier for stopping (a horizontal line), and a classifier for a hand (a hand with fingers spread).</p>

American Sign Language (ASL) Dictionary

Unedited 08082023

Spoken Word	SignWriting
Roadrunner running and looking	<p>The SignWriting symbol consists of a circle with a star inside, a vertical line, a hand with fingers spread, a hand with fingers spread, a hand with fingers spread, and a hand with fingers spread.</p>
Roadrunner running intensely	<p>The SignWriting symbol consists of a circle with a star inside, a vertical line, a hand with fingers spread, a hand with fingers spread, a hand with fingers spread, and a hand with fingers spread.</p>
Roadrunner running slow motion	<p>The SignWriting symbol consists of a circle with a star inside, a vertical line, a hand with fingers spread, a hand with fingers spread, a hand with fingers spread, and a hand with fingers spread.</p>
Roadrunner running slow motion open mouth	<p>The SignWriting symbol consists of a circle with a star inside, a vertical line, a hand with fingers spread, a hand with fingers spread, a hand with fingers spread, and a hand with fingers spread.</p>







American Sign Language (ASL) Dictionary

Unedited 08082023

Spoken Word	SignWriting
roadrunner runs extremely fast classifier	<p>The signwriting consists of a circle containing the number 12, with a small vertical line above it. Below this is a horizontal line with a downward-pointing arrow. To the right is a hand icon with a star above it, and a squiggle below it.</p>
Roadrunner runs straight classifier	<p>The signwriting consists of a circle containing a star, with a small vertical line above it. Below this is a horizontal line with a downward-pointing arrow. To the right is a hand icon with a star above it, and an upward-pointing arrow below it.</p>
Roadrunner stops	<p>The signwriting consists of a circle containing the number 12, with a horizontal line below it. Below the line is a hand icon with a star above it. To the right is another hand icon with a star above it and a squiggle below it.</p>
Roadrunner turns left classifier	<p>The signwriting consists of a circle containing a star, with a small vertical line above it. Below this is a horizontal line with a downward-pointing arrow. To the right is a hand icon with a star above it, and a leftward-pointing arrow below it.</p>
robot	<p>The signwriting consists of two hand icons. The left hand has a star above it and two upward-pointing arrows below it. The right hand has a star above it and two downward-pointing arrows below it.</p>
Rochester	<p>The signwriting consists of a hand icon with a star above it, and a downward-pointing arrow to its right.</p>
Rochester, NY	<p>The signwriting consists of a hand icon with a star above it, and a squiggle to its right.</p>



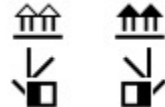



American Sign Language (ASL) Dictionary

Unedited 08082023

Spoken Word	SignWriting
rock	
rock	
rocket	
rocket	
rocket	
rocking chair	
rodent	



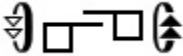

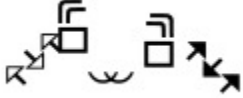

American Sign Language (ASL) Dictionary

Unedited 08082023

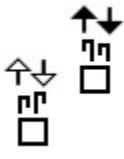
Spoken Word	SignWriting
Rodney	
Rodney Rensch	
roleshift-neutral	
roleshift-neutral	
roll	
roll	
roller skating	
roller-skates	





American Sign Language (ASL) Dictionary

Unedited 08082023

Spoken Word	SignWriting
rollerblade	
rollerskate	
Romania	
Romanian	
Romans	
romantic	
Rome	
Rome, GA	

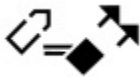

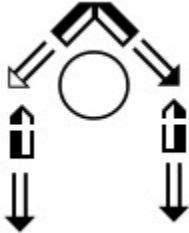

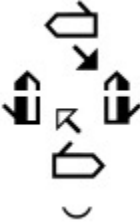

American Sign Language (ASL) Dictionary

Unedited 08082023

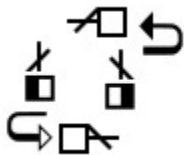
Spoken Word	SignWriting
Romero	
Ron	
roof	
roofer	
room	
room	
room	

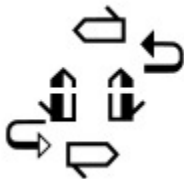



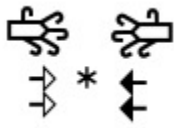



American Sign Language (ASL) Dictionary

Unedited 08082023

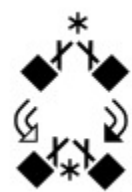
Spoken Word	SignWriting
room	
room	
room	
roommate	
roommate	
roommate	
roommate	
roommate	



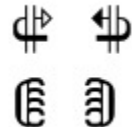

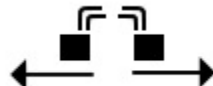



American Sign Language (ASL) Dictionary

Unedited 08082023

Spoken Word	SignWriting
rooster	
rope	
rosary	
rotate left forward	
rotten	
rough	
round	
round	
row	
row (of people sitting)	

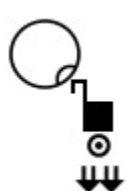
American Sign Language (ASL) Dictionary

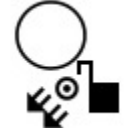
Unedited 08082023

Spoken Word	SignWriting
row (of people standing)	 The sign is represented by two hands with fingers spread, positioned side-by-side. A horizontal double-headed arrow with an asterisk in the center is drawn below the hands, indicating the width of the row.
row (of people standing)	 The sign is represented by two hands with fingers spread, positioned side-by-side. A horizontal double-headed arrow with an asterisk in the center is drawn below the hands, indicating the width of the row.
royal	 The sign is represented by a horizontal line above a hand with fingers spread. A diagonal arrow points from the hand towards the bottom right, and another diagonal arrow points from the top right towards the hand. Two asterisks are placed near the arrows.
rub	 The sign is represented by two hands with fingers spread, one above the other. A circular arrow indicates a clockwise motion around the upper hand.
rub	 The sign is represented by two hands with fingers spread, one above the other. A circular arrow indicates a clockwise motion around the upper hand. Additionally, there are two arrows pointing outwards from the hands.
rubber	 The sign is represented by a circle above a hand with fingers spread. A vertical arrow points downwards from the hand, and a circular arrow indicates a clockwise motion around the hand.
rubber	 The sign is represented by two hands with fingers spread, one above the other. Two asterisks are placed between the hands.
rubber	 The sign is represented by two hands with fingers spread, one above the other. Two asterisks are placed between the hands.
rubber	 The sign is represented by a circle above a hand with fingers spread. A circular arrow indicates a clockwise motion around the hand, and a vertical arrow points downwards from the hand.
rubberneck	 The sign is represented by a circle with two horizontal lines inside, above a hand with fingers spread. A diagonal arrow points upwards and to the right from the hand.

American Sign Language (ASL) Dictionary

Unedited 08082023

Spoken Word	SignWriting
rude	
rude	
rude	
rule	
rule of thumb	
ruler	
rules	
rules	







American Sign Language (ASL) Dictionary

Unedited 08082023

Spoken Word	SignWriting
rumor	<p>The SignWriting for 'rumor' consists of three overlapping circles at the top. Below them are two square boxes, one on the left and one on the right, each containing a bracket-like symbol. At the bottom, there are four square boxes: two on the left and two on the right, with a curved arrow pointing from the right side towards the center.</p>
run	<p>The SignWriting for 'run' features a central vertical arrow pointing upwards. On either side of the arrow are two square boxes, each with a dot above it. Below the arrow is a horizontal dashed line with a small asterisk centered underneath it.</p>
run	<p>The SignWriting for 'run' shows a central square box with a plus sign above it and a minus sign below it. To the right, there is another square box with a dot above it and an arrow pointing diagonally upwards and to the right.</p>
run	<p>The SignWriting for 'run' includes a central circle with a horizontal line through it. To the left is a square box with a dot above it and a curved arrow pointing upwards. To the right is another square box with a dot above it and a curved arrow pointing upwards. Below the circle is a small crescent moon shape.</p>
run	<p>The SignWriting for 'run' is identical to the previous entry, showing a central square box with a plus sign above and a minus sign below, and a square box to the right with a dot above and an arrow pointing diagonally upwards and to the right.</p>
run	<p>The SignWriting for 'run' features a central vertical arrow pointing upwards. On either side of the arrow are two square boxes, each with a dot above it. Below the arrow is a horizontal dashed line with a small asterisk centered underneath it.</p>
run	<p>The SignWriting for 'run' shows a central square box with a plus sign above it and a minus sign below it. To the right, there is another square box with a dot above it and an arrow pointing diagonally upwards and to the right.</p>

American Sign Language (ASL) Dictionary

Unedited 08082023

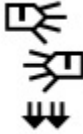
Spoken Word	SignWriting
run	
run	
run	
run	
run a machine	
run at angle	
running water	







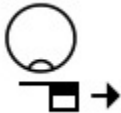
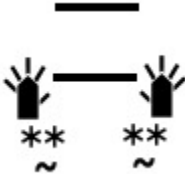

American Sign Language (ASL) Dictionary

Unedited 08082023

Spoken Word	SignWriting
running-hard	<p>The signwriting consists of a face with a wide, strained expression and a curved line above it indicating a high-pitched or intense sound. Below the face are two sets of hand symbols, each with a small square and a plus sign, and two upward-pointing arrows, suggesting a strenuous or fast-paced action.</p>
Rural area	<p>The signwriting features a hand symbol with fingers spread, a small circle with a dot inside, and another hand symbol with fingers spread. Below these are two circular arrows, one pointing clockwise and one counter-clockwise, representing a rural or open area.</p>
rush	<p>The signwriting shows a hand symbol with fingers spread, a small square, and a downward-pointing arrow, representing a sudden or hurried movement.</p>
Russell (n)	<p>The signwriting includes a vertical line, a hand symbol with a small square and a plus sign, and another hand symbol with a small square and a plus sign, representing the name Russell.</p>
Russia	<p>The signwriting features a large circle, a small circle with a dot inside, a hand symbol with a small square and a plus sign, and a hand symbol with a small square and a plus sign, representing the country Russia.</p>
Russia	<p>The signwriting consists of a vertical line, a hand symbol with a small square and a plus sign, and another hand symbol with a small square and a plus sign, representing the country Russia.</p>
Russia	<p>The signwriting features a vertical line, a hand symbol with a small square and a plus sign, and another hand symbol with a small square and a plus sign, representing the country Russia.</p>







American Sign Language (ASL) Dictionary

Unedited 08082023

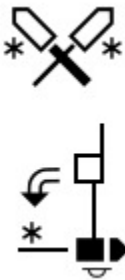
Spoken Word	SignWriting
Russia	
Russian	
rustler	
Ryan	
Ryan	
S	
S Sign name	
S-Receptive	
S-Receptive	

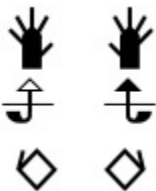

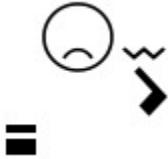



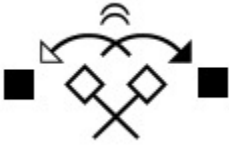

American Sign Language (ASL) Dictionary

Unedited 08082023

Spoken Word	SignWriting
Sabbath	
Sabbath	
sacrifice	
sad	
sad goodbye on motorcycle	
safe	
safe	







American Sign Language (ASL) Dictionary

Unedited 08082023

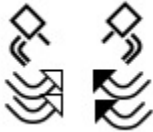
Spoken Word	SignWriting
safe	
safety	
safety	
saguaro	
sailboat	
Saint Louis	
sake	
salad	

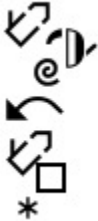





American Sign Language (ASL) Dictionary

Unedited 08082023

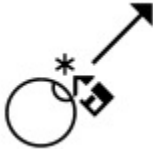
Spoken Word	SignWriting
salad	
salad	
salad dressing	
salary	
salary	
salt	
salt	
Salt Lake City	

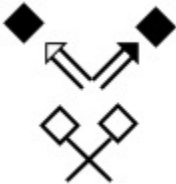
American Sign Language (ASL) Dictionary

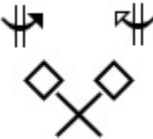
Unedited 08082023

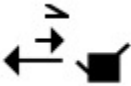
Spoken Word	SignWriting
salute	
Salvador Dali	
salvation	
salvation	
salvation	
salvation	
Sam	
same	





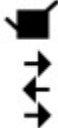
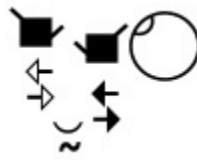



American Sign Language (ASL) Dictionary

Unedited 08082023

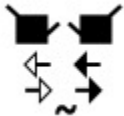
Spoken Word	SignWriting
same	
same	
same	









American Sign Language (ASL) Dictionary

Unedited 08082023

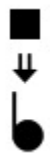
Spoken Word	SignWriting
same	
same all over	
same all over	
same exactly	
same old	
same old thing	
same old thing	
same time	
SAMPLE SIGN	
San Diego	



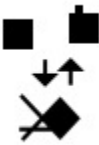

American Sign Language (ASL) Dictionary

Unedited 08082023

Spoken Word	SignWriting
San Francisco	
San Francisco	
San-Diego	
sand	
sandal	
sandal	
sandals	
SANDPOINT	
sandwich	





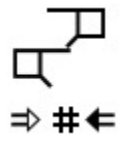
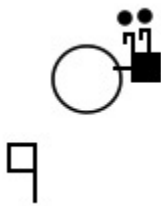

American Sign Language (ASL) Dictionary

Unedited 08082023

Spoken Word	SignWriting
sandwich	
sandwich	
sandwich 2	
Santa	
sarcasm	
sarcasm	
Satan	



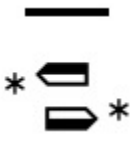
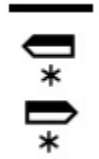



American Sign Language (ASL) Dictionary

Unedited 08082023

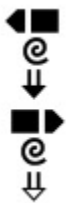
Spoken Word	SignWriting
satelite	
satellite	
satisfied	
satisfied	
satisfied	
satisfies	
satisfy	







American Sign Language (ASL) Dictionary

Unedited 08082023

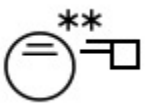
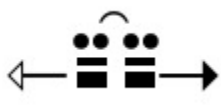
Spoken Word	SignWriting
satisfy	
satisfy	
Saturday	
Saturday	
saturn	
Saturn	
Saturn	
sauce	

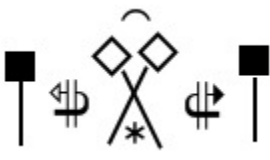





American Sign Language (ASL) Dictionary

Unedited 08082023

Spoken Word	SignWriting
Saudi Arabia	
sausage	
save	
save	
save	
save	
save	
save	
save	



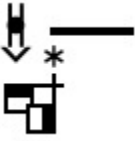



American Sign Language (ASL) Dictionary

Unedited 08082023

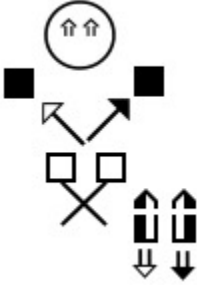
Spoken Word	SignWriting
save	
save	
save	
save	
save money	
saved	
saved	
saved	









American Sign Language (ASL) Dictionary

Unedited 08082023

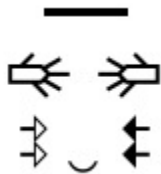
Spoken Word	SignWriting
savings	
Savior	
saw	
say	
say	
say	
say	
say-no	





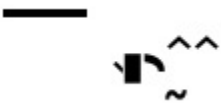

American Sign Language (ASL) Dictionary

Unedited 08082023

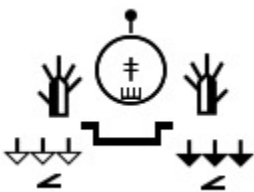
Spoken Word	SignWriting
say-no-to-me	
SC	
scared	
scared	
scared	
scared	
scarf	
scarf	
scat	

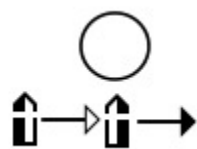







American Sign Language (ASL) Dictionary

Unedited 08082023

Spoken Word	SignWriting
scenery whizzing by vehicle intensely fast	
schedule	
schedule	
scheme	
scheming	
schizophrenia	
schizophrenia	
scholarly	
school	
school	





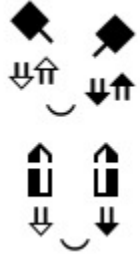

American Sign Language (ASL) Dictionary

Unedited 08082023

Spoken Word	SignWriting
school	
school	
schoolwork	
science	
science	
science	
science	
science	
scientist	







American Sign Language (ASL) Dictionary

Unedited 08082023

Spoken Word	SignWriting
scientist	
scientist	
scientist	
scissor	
scissor	
scissor	

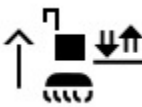
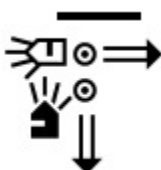







American Sign Language (ASL) Dictionary

Unedited 08082023

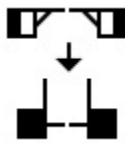
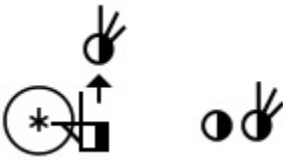
Spoken Word	SignWriting
scissors	
scoop	
scooped neck shirt	
scorpion	
Scotland	
Scottish	
scour	
scout	
scramble	



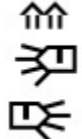



American Sign Language (ASL) Dictionary

Unedited 08082023

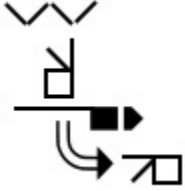
Spoken Word	SignWriting
scratch	
screen	
screen-on	
screw-off	
scribble	
scrimmage	
scroll	
scrolling	
scrolling	

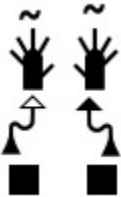
American Sign Language (ASL) Dictionary

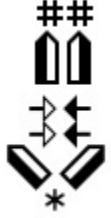
Unedited 08082023

Spoken Word	SignWriting
scrub	
Scuba	
scuba	
Sculpt	
sea	
sea turtle	
seal	
search	









American Sign Language (ASL) Dictionary

Unedited 08082023

Spoken Word	SignWriting
search	
search	
search	
search	
search	
search	
search	
season	
Seattle	
seaweed	



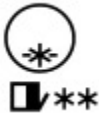



American Sign Language (ASL) Dictionary

Unedited 08082023

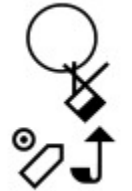
Spoken Word	SignWriting
secluded	
second	
second of five	
second of three	
second of three	
secondly	
secret	
secret	
secret	
secret	









American Sign Language (ASL) Dictionary

Unedited 08082023

Spoken Word	SignWriting
secretary	
secretary	
secretary	
secretary	
section	
security	
sediment	



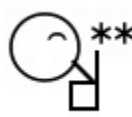

American Sign Language (ASL) Dictionary

Unedited 08082023

Spoken Word	SignWriting
See	
see	
see	
see	
see	
see	
see	
see	
see	

American Sign Language (ASL) Dictionary

Unedited 08082023

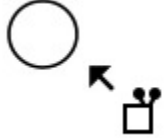
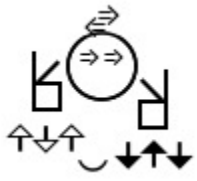
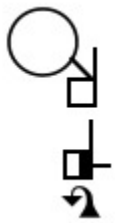
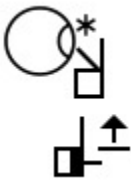
Spoken Word	SignWriting
see	
see	
see	
see	
see me	
see things around	
see you later	
see you later	







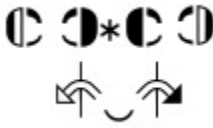

American Sign Language (ASL) Dictionary

Unedited 08082023

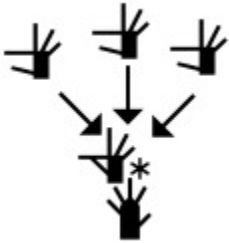
Spoken Word	SignWriting
see you tomorrow	
see-none	
see-you	
seed	
seeing-Him-on-me	
seem	
Seesaw	
seesaw	







American Sign Language (ASL) Dictionary

Unedited 08082023

Spoken Word	SignWriting
segment	
seldom	
select	
select	
self	
self	
self	
self	
self	

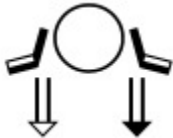
American Sign Language (ASL) Dictionary

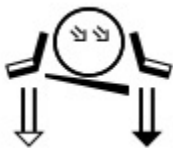
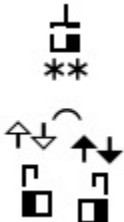
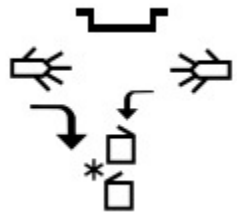
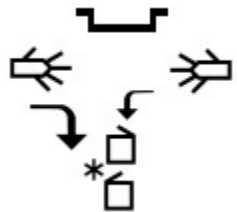
Unedited 08082023

Spoken Word	SignWriting
self	
self	
self	
self	
self	
self control	 
self control	
self-determination	 





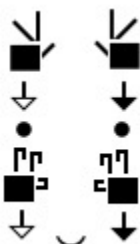
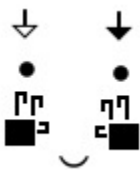
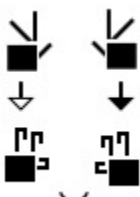
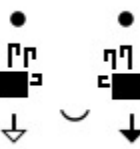
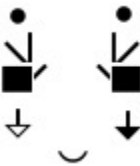
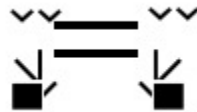

American Sign Language (ASL) Dictionary

Unedited 08082023

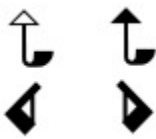
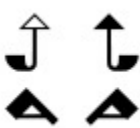
Spoken Word	SignWriting
selfish	
selfish	
selfish	
selfish	
selfish	
selfish	







American Sign Language (ASL) Dictionary

Unedited 08082023

Spoken Word	SignWriting
Selina	
sell	
sell	
selling	
semantics	
semester	
semester	
semi-permeable	

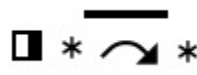
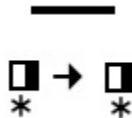
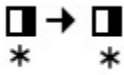





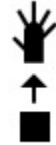

American Sign Language (ASL) Dictionary

Unedited 08082023

Spoken Word	SignWriting
semicircle	
senate	
senate	
senate	
senator	
send	
send	
send	
send	

American Sign Language (ASL) Dictionary

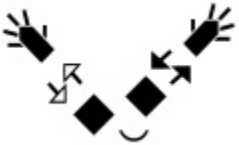
Unedited 08082023

Spoken Word	SignWriting
send	
send	
send	
send	
send	
send	
send	
send	







American Sign Language (ASL) Dictionary

Unedited 08082023

Spoken Word	SignWriting
send (v) they send you	<p>The signwriting consists of a hand with fingers spread pointing up, a small square to its right, and an arrow pointing up from below the hand.</p>
send-down	<p>The signwriting consists of a hand with fingers spread pointing up, a diamond shape below it, a diagonal line extending from the diamond to the left, a small circle to the right of the diamond, and a vertical line with a small square at the bottom below the diamond.</p>
send-to-me	<p>The signwriting consists of a small square, an arrow pointing down from the square, and a hand with fingers spread pointing up below the arrow.</p>
Senior	<p>The signwriting consists of a hand with fingers spread pointing up, a hand with fingers spread pointing down to its right, and a hand with fingers spread pointing up below the other two, with two asterisks to its right.</p>
senior	<p>The signwriting consists of a hand with fingers spread pointing up, a hand with fingers spread pointing down to its right, and a hand with fingers spread pointing up below the other two, with two asterisks to its right.</p>
senior	<p>The signwriting consists of two hands with fingers spread pointing up, one to the left of the other, with two asterisks below them.</p>
senior	<p>The signwriting consists of a hand with fingers spread pointing up, a hand with fingers spread pointing down to its right, and a hand with fingers spread pointing up below the other two, with two asterisks to its left.</p>
senior citizens	<p>The signwriting consists of a circle, a hand with fingers spread pointing up to its left, a hand with fingers spread pointing up to its right, and an arrow pointing left below the circle, with two asterisks on either side of the arrow.</p>





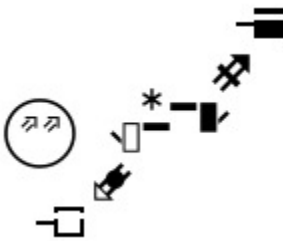

American Sign Language (ASL) Dictionary

Unedited 08082023

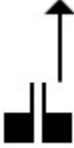
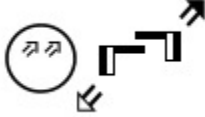
Spoken Word	SignWriting
senior class	
Sennacherib	
sense	
sensitive	
sentence	
sentence	
sentence	
separate	

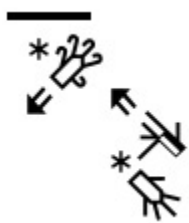
American Sign Language (ASL) Dictionary

Unedited 08082023

Spoken Word	SignWriting
separate	
separate	
separate	
September	
sequim	
serious	
serious	
serious head on collision	

American Sign Language (ASL) Dictionary

Unedited 08082023

Spoken Word	SignWriting
serious head on collision	
servant	
servant	
serve	
serve	
serve	
serve	





American Sign Language (ASL) Dictionary

Unedited 08082023

Spoken Word	SignWriting
server	<p>The signwriting for 'server' consists of two vertical columns. Each column starts with a double-headed vertical arrow (up and down). Below the arrow is a U-shaped hand symbol. The second column has a solid black rectangle below the U-shaped hand, and a double-headed vertical arrow at the bottom.</p>
service	<p>The signwriting for 'service' consists of two vertical columns. Each column starts with a double-headed vertical arrow (up and down). Below the arrow is a U-shaped hand symbol.</p>
service	<p>The signwriting for 'service' consists of a central cluster of arrows pointing in various directions (up, down, left, right, and diagonals). Below this cluster are two U-shaped hand symbols.</p>
service	<p>The signwriting for 'service' consists of a central cluster of arrows pointing in various directions (up, down, left, right, and diagonals). Below this cluster are two U-shaped hand symbols.</p>
service	<p>The signwriting for 'service' consists of a central cluster of arrows pointing in various directions (up, down, left, right, and diagonals). Below this cluster are two U-shaped hand symbols.</p>
set	<p>The signwriting for 'set' consists of a central cluster of symbols: a hash symbol (#), a square with a vertical line through its center, a triangle pointing up, and a square with a circle inside.</p>
set	<p>The signwriting for 'set' consists of a central cluster of symbols: a hash symbol (#), a square with a vertical line through its center, and a solid black rectangle.</p>





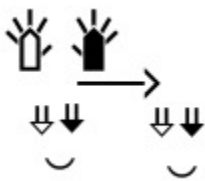
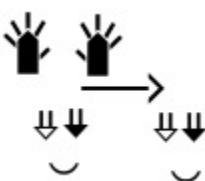
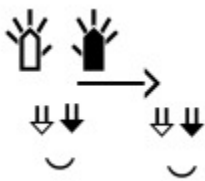



American Sign Language (ASL) Dictionary

Unedited 08082023

Spoken Word	SignWriting
set the table	
set the table	
set up	
settle down	
settle-down	
settle-down	
seven dollars	

American Sign Language (ASL) Dictionary

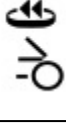
Unedited 08082023

Spoken Word	SignWriting
seven hours	
seven minutes	
seven months	
seven o'clock	
seven o'clock	
seven of them	
seven of us	
seven of us (left hand)	
seven of us (left hand)	







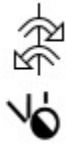

American Sign Language (ASL) Dictionary

Unedited 08082023

Spoken Word	SignWriting
seven weeks	
seven years old	
seven years old	
seven-of-us	
Seven-Up	
seventeen years old	
seventeen years old	
seventeen years old	
seventh	



American Sign Language (ASL) Dictionary

Unedited 08082023

Spoken Word	SignWriting
seventh (in a series)	
seventh (in a series)	
seventy eight	
seventy nine	
seventy six	
several	
severe	
sew	



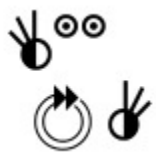



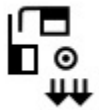

American Sign Language (ASL) Dictionary

Unedited 08082023

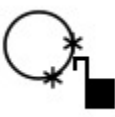
Spoken Word	SignWriting
sew	
sew	
sew	
sew-by-hand	







American Sign Language (ASL) Dictionary

Unedited 08082023

Spoken Word	SignWriting
Sewdish	
sewing machine	
sewing-machine	
sex	
sh	
shadow	
shadow-Almighty	 
shake hands	

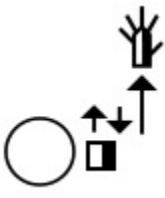

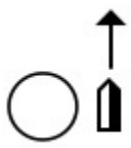
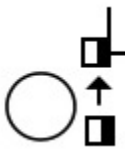
American Sign Language (ASL) Dictionary

Unedited 08082023

Spoken Word	SignWriting
shake over top	
shaken	
Shakespeare	
shaky	
shall	
shall	
shame	
shame	

American Sign Language (ASL) Dictionary

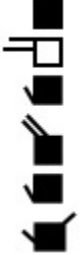
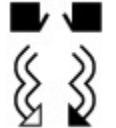
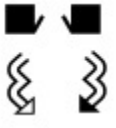
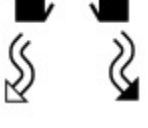
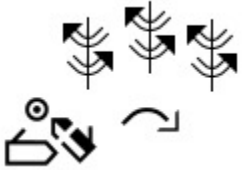
Unedited 08082023

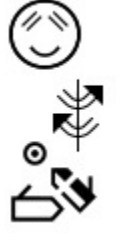
Spoken Word	SignWriting
Shanay	
shape	
shape	
shape	
share	
share	
share	





American Sign Language (ASL) Dictionary

Unedited 08082023

Spoken Word	SignWriting
share	
share	
shark	
shark	
sharp	
shave	
shave	
shave	

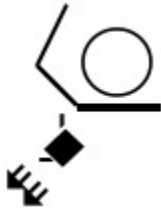
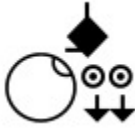

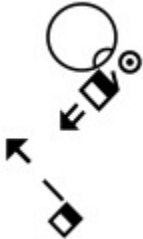

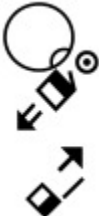

American Sign Language (ASL) Dictionary

Unedited 08082023

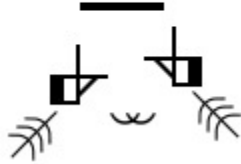
Spoken Word	SignWriting
shave arm pits	
shave head	
she	
she-left	
she-to-the-left	
she-to-the-left	
she-to-the-right	







American Sign Language (ASL) Dictionary

Unedited 08082023

Spoken Word	SignWriting
shedding	 
sheet	
shelf	
shelf	
shelf	
shell	
shell	



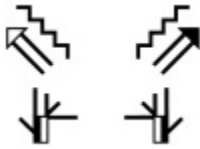

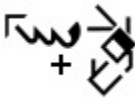
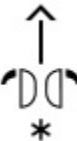

American Sign Language (ASL) Dictionary

Unedited 08082023

Spoken Word	SignWriting
shelter	 
shhh	
shhh	
shield	
shine	
ship	
ship	
ship	



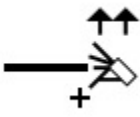
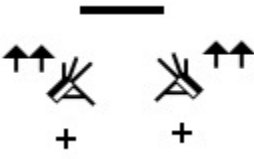
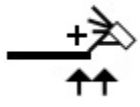



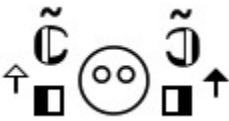

American Sign Language (ASL) Dictionary

Unedited 08082023

Spoken Word	SignWriting
ship	
ship	
ship	
ship	
shipping	
shirt	
shirt	
shirt	
shit	

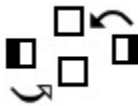



American Sign Language (ASL) Dictionary

Unedited 08082023

Spoken Word	SignWriting
shocked	
shoe	
shoes	
shoot-into-air	
shop	
shop	
shopping	
shopping	
shopping	
shopping 3 movements	

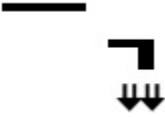
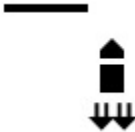
American Sign Language (ASL) Dictionary

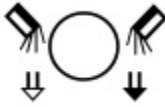
Unedited 08082023

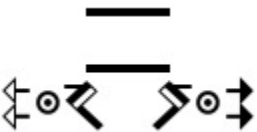
Spoken Word	SignWriting
short	
short	
short sleeve	
short straight hair	
short-time	
shortcut	
shorts	









American Sign Language (ASL) Dictionary

Unedited 08082023

Spoken Word	SignWriting
shorts	
should	
shoulder circle	
shoulder circles	
shoulder circles	
shoulder shift left	
shoulder shift right	
shoulder tap	

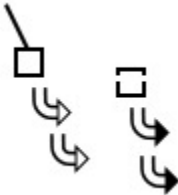
American Sign Language (ASL) Dictionary

Unedited 08082023

Spoken Word	SignWriting
shoulders	
shoulders	
shoulders-left	
shoulders-right	
shovel	
show	
show	
show all	
show me	







American Sign Language (ASL) Dictionary

Unedited 08082023

Spoken Word	SignWriting
show-me-show-all	<p>The SignWriting for 'show-me-show-all' consists of three main components: a vertical line with a downward arrow, a circle with a horizontal line through its center, and a square with a downward arrow. Below these are a solid black square, a square with a downward arrow, and a curved arrow pointing to the right.</p>
shower	<p>The SignWriting for 'shower' features a circle on the left, followed by a hand with fingers spread, and a series of arrows pointing upwards and to the right towards a square.</p>
shower	<p>The SignWriting for 'shower' includes a circle on the left, a hand with fingers spread, and arrows pointing up and right to a square. To the right of this is a separate set of symbols: two squares with arrows pointing down and up, an '@' symbol, and a curved arrow pointing down.</p>
shower	<p>The SignWriting for 'shower' shows a circle on the left, a hand with fingers spread, and arrows pointing up and right to a square. To the right of the square are three small circles and a square with a downward arrow.</p>

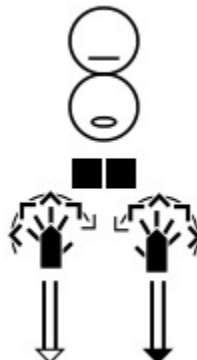

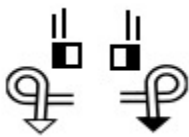
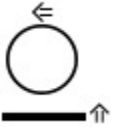



American Sign Language (ASL) Dictionary

Unedited 08082023

Spoken Word	SignWriting
shower	
shower	
shrapnel-falling	
shrimp	
shrine	
shrug	
shrug	
shrug	

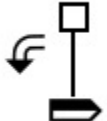



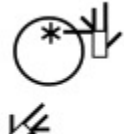

American Sign Language (ASL) Dictionary

Unedited 08082023

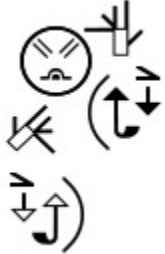
Spoken Word	SignWriting
shrug	
shrug	
shut up	
shutdown	
shy	
shy	
shy	
sick	

American Sign Language (ASL) Dictionary

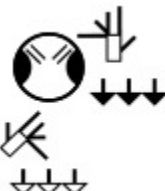
Unedited 08082023

Spoken Word	SignWriting
sick	
sick	
sick	
sick	
sick	
sick	

American Sign Language (ASL) Dictionary

Unedited 08082023

Spoken Word	SignWriting
sick it	
sick of it	
Sick Spanish	
sick to stomach	
sick-of-it	
side	
side car damage	

American Sign Language (ASL) Dictionary

Unedited 08082023

Spoken Word	SignWriting
side collision	
side dent	
side ponytails	
sideburns	
sigh	
sightsee	
sightsee	
sightsee	
sightsee	

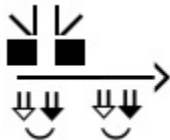
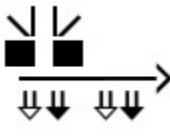
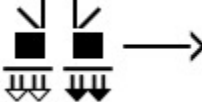
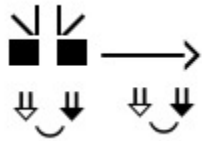
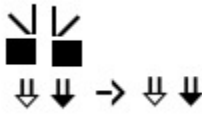
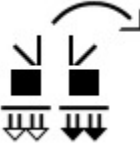
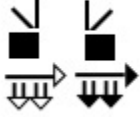
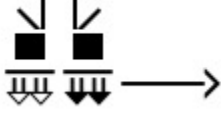
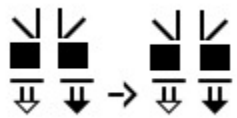

American Sign Language (ASL) Dictionary

Unedited 08082023

Spoken Word	SignWriting
sightsee	
sightsee	
sightsee	
sightsee	
sightsee	
sightsee	
sightsee	
sightsee	
sightsee	



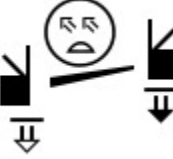
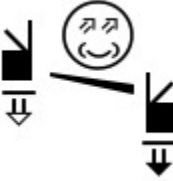
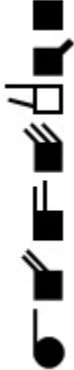

American Sign Language (ASL) Dictionary

Unedited 08082023

Spoken Word	SignWriting
sightsee	
sightseeing	
sightseeing	
sightseeing	
Sigmund	
sign	
sign	

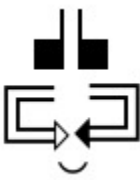
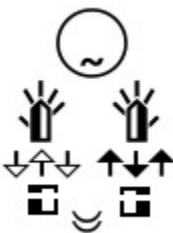

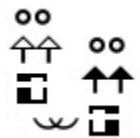

American Sign Language (ASL) Dictionary

Unedited 08082023

Spoken Word	SignWriting
sign	
sign	
sign	
sign	
sign	
sign	
sign	

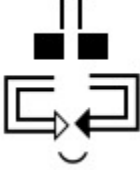

American Sign Language (ASL) Dictionary

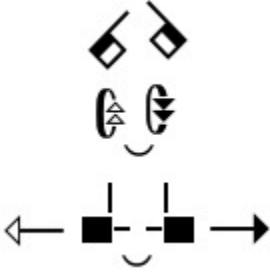
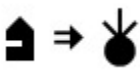
Unedited 08082023

Spoken Word	SignWriting
sign	
sign	
sign	
sign	
sign language	
Sign Name	



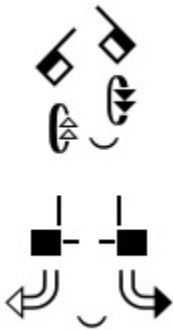
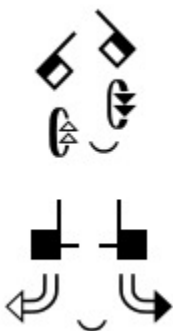
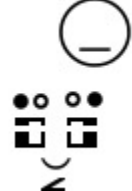
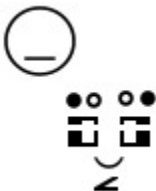
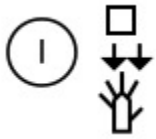



American Sign Language (ASL) Dictionary

Unedited 08082023

Spoken Word	SignWriting
sign-language	
sign-language	
sign-on-left	
sign-on-right	
sign-to-me	
signature	

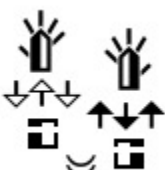

American Sign Language (ASL) Dictionary

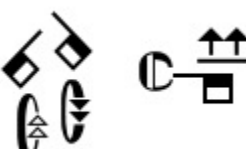
Unedited 08082023

Spoken Word	SignWriting
SignBank	
SignBank	
significant other	
signing	
signing	
signing	
signing	
signmail	



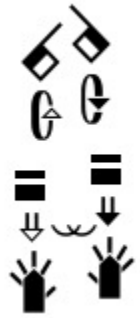
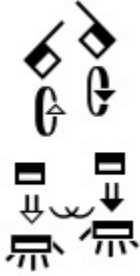
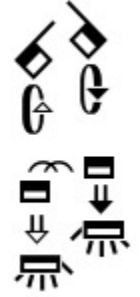

American Sign Language (ASL) Dictionary

Unedited 08082023

Spoken Word	SignWriting
SignMail to Bill Reese	
SignMaker	
SignPuddle	
SignPuddle	
SignPuddle	
SignPuddle	

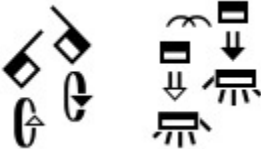

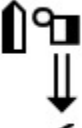

American Sign Language (ASL) Dictionary

Unedited 08082023

Spoken Word	SignWriting
SignPuddle	
SignPuddle Online	
SignPuddle Online	
SignText	
SignText	
SignText	
SignText	

American Sign Language (ASL) Dictionary

Unedited 08082023

Spoken Word	SignWriting
SignText	
SignText	
SignText	
SignText	
SignText	

American Sign Language (ASL) Dictionary

Unedited 08082023

Spoken Word	SignWriting
SignWriting	 The SignWriting symbols for the word 'SignWriting' are arranged vertically. The top part shows two hand configurations: the left hand with fingers spread and thumb up, and the right hand with fingers spread and thumb up. Below these are two sets of arrows: the first set has a left-pointing arrow above a right-pointing arrow, and the second set has a right-pointing arrow above a left-pointing arrow. A small square is positioned between the two arrow sets. Below the arrows is a crescent moon symbol. The middle part of the symbols shows a hand configuration with the index finger pointing up and the thumb pointing right, with a small square below it. The bottom part shows a hand configuration with the index finger pointing up and the thumb pointing right, with a small square below it. At the very bottom is a hash symbol (#).

American Sign Language (ASL) Dictionary

Unedited 08082023

Spoken Word	SignWriting
SignWriting	
SignWriting	
SignWriting (S-W)	
SignWriting Class Invite Transcription	
SignWriting Image Server	







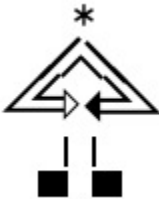

American Sign Language (ASL) Dictionary

Unedited 08082023

Spoken Word	SignWriting
SignWriting List	
SignWriting_list	
SIL 2007	
SIL 2007	
SIL 2007	
SIL 2007	







American Sign Language (ASL) Dictionary

Unedited 08082023

Spoken Word	SignWriting
SIL 2007	
SIL 2007	
SIL 2007	
SIL 2007	
SIL 2007	
SIL 2007	
SIL 2007	
SIL 2007	
SIL 2007	



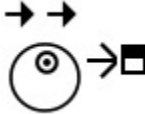



American Sign Language (ASL) Dictionary

Unedited 08082023

Spoken Word	SignWriting
SIL 2007	
SIL 2007	
SIL 2007	
SIL 2007	
SIL 2007	
SIL 2007	
SIL2007	
SIL2007	
SIL2007	
SIL2007	
SIL2007	



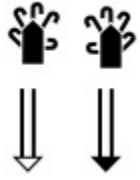
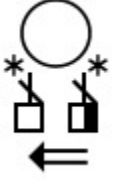
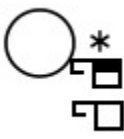

American Sign Language (ASL) Dictionary

Unedited 08082023

Spoken Word	SignWriting
SIL2007	
SIL2007	
SIL2007	
SIL2007	
SIL2007	
SIL2007	
SIL2007	
SIL2007	



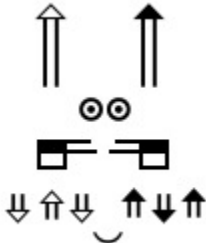
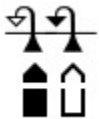
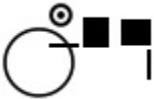

American Sign Language (ASL) Dictionary

Unedited 08082023

Spoken Word	SignWriting
SIL2007	
SIL2007	
SIL2007	
SIL2007	
SIL2007	
SIL2007	
SIL2007	
SIL2007	
SIL2007	
SIL2007	
SIL2007	
SIL2007	



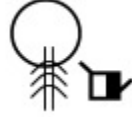
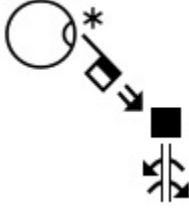



American Sign Language (ASL) Dictionary

Unedited 08082023

Spoken Word	SignWriting
SIL2007	
silly	
silly	
silly	
silly	
silver	
similar	
simple	

American Sign Language (ASL) Dictionary

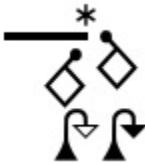
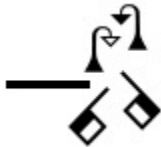
Unedited 08082023

Spoken Word	SignWriting
simple	
simultaneous	
simultaneous arc	
sin	
sin	
since	
since	
sing	

American Sign Language (ASL) Dictionary

Unedited 08082023

Spoken Word	SignWriting
Sing	<p>The SignWriting for 'Sing' consists of two small circles at the top, two squares below them, two curved arrows pointing outwards, and a small crescent moon at the bottom.</p>
Singapore	<p>The SignWriting for 'Singapore' consists of a wavy line above a square with a hand-like shape extending from its right side.</p>
Singapore	<p>The SignWriting for 'Singapore' consists of a circle with a horizontal line through it, a double-headed arrow, an asterisk, and a diamond shape.</p>
Singapore	<p>The SignWriting for 'Singapore' consists of a circle with a horizontal line through it, a double-headed arrow, a circle with a horizontal line through it, a double-headed arrow, an asterisk, and a diamond shape.</p>
single	<p>The SignWriting for 'single' consists of a circle, a square, a double-headed arrow, and two asterisks.</p>
single	<p>The SignWriting for 'single' consists of a circle with a horizontal line through it, an upward-pointing arrow, a square, and a tilde symbol.</p>
single	<p>The SignWriting for 'single' consists of a square, a double-headed arrow, and a hand-like shape.</p>





American Sign Language (ASL) Dictionary

Unedited 08082023

Spoken Word	SignWriting
single	
single	
siren	
sister	
sister	
sister	
sister	

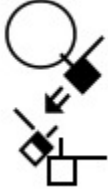
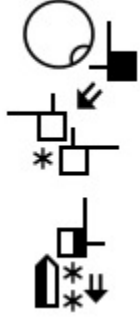
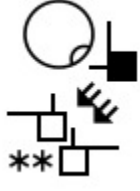



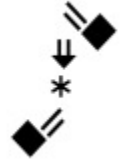

American Sign Language (ASL) Dictionary

Unedited 08082023

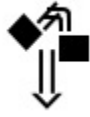
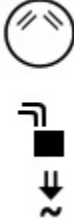
Spoken Word	SignWriting
sister	
sister-in-law	
sisters	
sit	
sit	
sit	
sit	

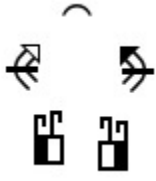

American Sign Language (ASL) Dictionary

Unedited 08082023

Spoken Word	SignWriting
sit	
sit	
sit	
sit	
sit long time	
sit-circle	
sit-circle2	
sit-facing	



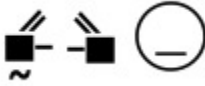

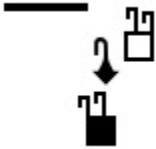

American Sign Language (ASL) Dictionary

Unedited 08082023

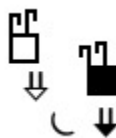
Spoken Word	SignWriting
sit-on-right	
sit-on-throne	
sit-on-throne	
sit-right	

American Sign Language (ASL) Dictionary

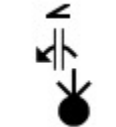
Unedited 08082023

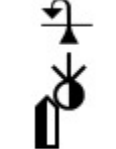
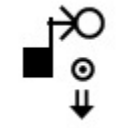
Spoken Word	SignWriting
sit-together	
sit_together	
situation	
situation	
six dollars	
six hours	
six minutes	
six months	

American Sign Language (ASL) Dictionary

Unedited 08082023

Spoken Word	SignWriting
six o'clock	
six of us	
six of us	
six of us	
six of us (right hand)	
six weeks	
six years old	
six years old	
sixteen years old	

American Sign Language (ASL) Dictionary

Unedited 08082023

Spoken Word	SignWriting
sixteen years old	
sixteen years old	
sixth	
sixth (in a series)	
sixth (in a series)	
sixty	
sixty eight	
sixty five years old	





American Sign Language (ASL) Dictionary

Unedited 08082023

Spoken Word	SignWriting
sixty nine	
sixty seven	
size	
size	
skateboard	
skateboard	
ski	
ski	





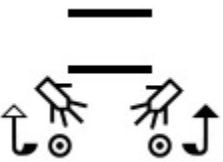
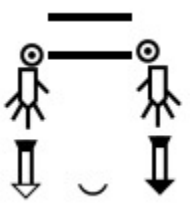



American Sign Language (ASL) Dictionary

Unedited 08082023

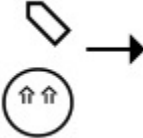
Spoken Word	SignWriting
skies	
skilled	
skin	
skinny	
skinny	
Skip Thomas	
skirt	
skirt	

American Sign Language (ASL) Dictionary

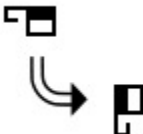
Unedited 08082023

Spoken Word	SignWriting
skirt	
skunk	
sky	
skydive	
skyrocket	
slaa	
slash	
slave	







American Sign Language (ASL) Dictionary

Unedited 08082023

Spoken Word	SignWriting
slave	<p>The SignWriting symbol for 'slave' consists of a crossed hammer and pickaxe. The hammer is positioned diagonally from the top-left to the bottom-right, and the pickaxe is positioned diagonally from the top-right to the bottom-left. The heads of the tools are represented by squares with a diagonal line through them.</p>
sleep	<p>The SignWriting symbol for 'sleep' consists of a hand with fingers spread, enclosed in a circle. Below this is a double-lined downward arrow, and at the bottom is a semi-circular shape representing a closed eye.</p>
sleep	<p>The SignWriting symbol for 'sleep' consists of a hand with fingers spread, enclosed in a circle. Below this is a double-lined downward arrow, and at the bottom is a square with a diagonal line from the bottom-left to the top-right.</p>
sleep	<p>The SignWriting symbol for 'sleep' consists of a hand with fingers spread, enclosed in a circle. Below this is a double-lined downward arrow, and at the bottom is a square with a diagonal line from the top-left to the bottom-right.</p>
sleep	<p>The SignWriting symbol for 'sleep' consists of a hand with fingers spread, enclosed in a circle. Below this is a double-lined downward arrow, and at the bottom is a square with a diagonal line from the top-left to the bottom-right. A small downward-pointing arrow is located to the right of the main downward arrow.</p>
sleep	<p>The SignWriting symbol for 'sleep' consists of a hand with fingers spread, enclosed in a circle. Below this is a double-lined downward arrow, and at the bottom is a square with a diagonal line from the top-left to the bottom-right. A second double-lined downward arrow is positioned to the right of the first one.</p>
sleep	<p>The SignWriting symbol for 'sleep' consists of a hand with fingers spread, enclosed in a circle. Below this is a double-lined downward arrow, and at the bottom is a square with a diagonal line from the top-left to the bottom-right. To the right of the main downward arrow is a small downward-pointing arrow with a checkmark above it.</p>
sleep	<p>The SignWriting symbol for 'sleep' consists of a hand with fingers spread, enclosed in a circle. Below this is a double-lined downward arrow, and at the bottom is a square with a diagonal line from the top-left to the bottom-right.</p>

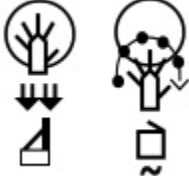





American Sign Language (ASL) Dictionary

Unedited 08082023

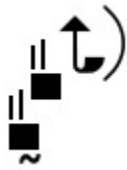
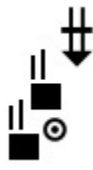
Spoken Word	SignWriting
sleep	
sleep in	
sleep-together	
Sleeping-Beauty	
sleepy	
sleepy	
slice	
slide	









American Sign Language (ASL) Dictionary

Unedited 08082023

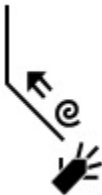
Spoken Word	SignWriting
slide	
slide	
slide	
slim	
slippers	
sloth	
Slovakia	
Slovakian	



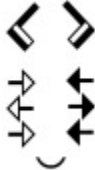



American Sign Language (ASL) Dictionary

Unedited 08082023

Spoken Word	SignWriting
Slovenia	
slow	
slow	
slow	
slow	
slow	
small	
small	
small	

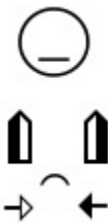

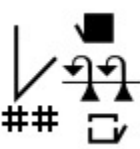







American Sign Language (ASL) Dictionary

Unedited 08082023

Spoken Word	SignWriting
small	
small	
small font	
small with mm mouth	
smart	
smart	
smash-with-the-elbow	
smell	







American Sign Language (ASL) Dictionary

Unedited 08082023

Spoken Word	SignWriting
smells bad	
smile	
smile	
smile	
smile	
smile	
smile	
smile eyebrows up	
smile head tilt right	
smiling	

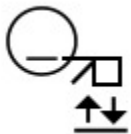







American Sign Language (ASL) Dictionary

Unedited 08082023

Spoken Word	SignWriting
smitten	
smoke	
smoke-clears	
smoking cigarette	
smoking pot	
smooth	
smooth	
smother	







American Sign Language (ASL) Dictionary

Unedited 08082023

Spoken Word	SignWriting
snail	
snake	
snake	
snake	
snap	
snap	
snap	
snap fingers	

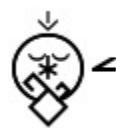
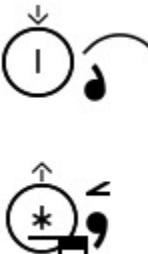

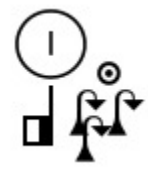
American Sign Language (ASL) Dictionary

Unedited 08082023

Spoken Word	SignWriting
sneak	
sneak	
sneeze	
sneeze	
sneeze	
sniff	
snobbish	
snore	



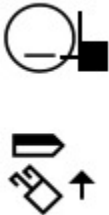

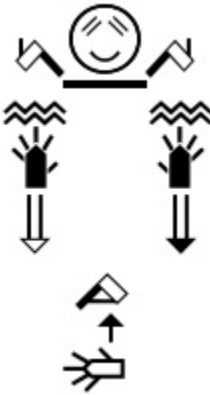
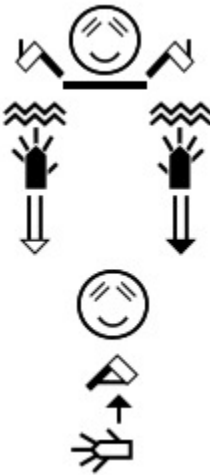

American Sign Language (ASL) Dictionary

Unedited 08082023

Spoken Word	SignWriting
snorkeling	
snow	
snow	
Snow White	
Snow White	



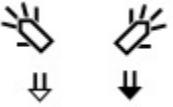



American Sign Language (ASL) Dictionary

Unedited 08082023

Spoken Word	SignWriting
snowball	
snowboard	
snowboard	
snowman	
so	
so	
so	



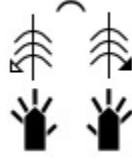





American Sign Language (ASL) Dictionary

Unedited 08082023

Spoken Word	SignWriting
SO	
so lucky	
SO-SO	
SO-SO	
SO-SO	
SO-SO	

American Sign Language (ASL) Dictionary

Unedited 08082023

Spoken Word	SignWriting
SO-SO	
soap	
soap	
sober	
soccer	
soccer	
social	
Social Security	
social worker	



American Sign Language (ASL) Dictionary

Unedited 08082023

Spoken Word	SignWriting
society	
society	
society	
society	
society	
sociology	
socks	
socks	





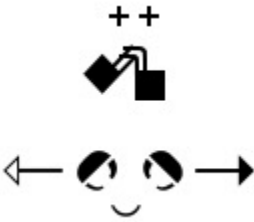
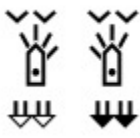
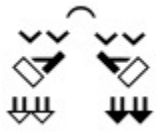
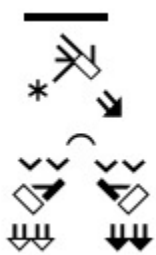

American Sign Language (ASL) Dictionary

Unedited 08082023

Spoken Word	SignWriting
soda	
soda	
soda	
sofa	
soft	
soft	
soft heart	

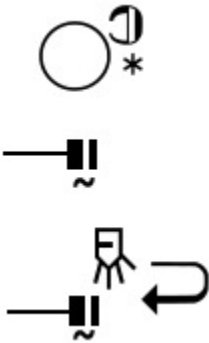
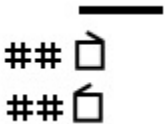
American Sign Language (ASL) Dictionary

Unedited 08082023

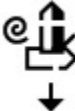
Spoken Word	SignWriting
software	
soiled	
solar system	
solar system	
soldier	
solid	
solid	
some	
some	

American Sign Language (ASL) Dictionary

Unedited 08082023

Spoken Word	SignWriting
some	
some	
someone	
someone	
someone	
someone-inform-you	
something	
something	







American Sign Language (ASL) Dictionary

Unedited 08082023

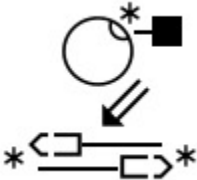
Spoken Word	SignWriting
something weird	<p>The SignWriting symbol for 'something weird' consists of a vertical line on the left, a circle with a horizontal line through it, and a vertical line with an upward-pointing arrow on the right.</p>
sometimes	<p>The SignWriting symbol for 'sometimes' features a hand with fingers spread, a vertical line with an upward arrow, a diamond shape, and a circle with a horizontal line through it.</p>
sometimes	<p>The SignWriting symbol for 'sometimes' includes a hand with fingers spread, a vertical line with an upward arrow, a diamond shape, and a circle with a horizontal line through it.</p>
sometimes	<p>The SignWriting symbol for 'sometimes' shows a hand with fingers spread, a vertical line with an upward arrow, a diamond shape, and a circle with a horizontal line through it.</p>
sometimes	<p>The SignWriting symbol for 'sometimes' depicts a hand with fingers spread, a vertical line with an upward arrow, a diamond shape, and a circle with a horizontal line through it.</p>
sometimes	<p>The SignWriting symbol for 'sometimes' features a hand with fingers spread, a vertical line with an upward arrow, a diamond shape, and a circle with a horizontal line through it.</p>
sometimes	<p>The SignWriting symbol for 'sometimes' includes a hand with fingers spread, a vertical line with an upward arrow, a diamond shape, and a circle with a horizontal line through it.</p>
somewhere	<p>The SignWriting symbol for 'somewhere' shows a smiling face with closed eyes, a vertical line with an upward arrow, a diamond shape, and a circle with a horizontal line through it.</p>

American Sign Language (ASL) Dictionary

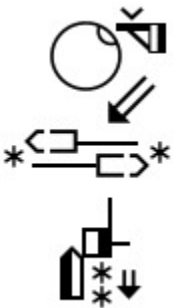
Unedited 08082023

Spoken Word	SignWriting
son	
son	
son	
son	
son-in-law	
sons	









American Sign Language (ASL) Dictionary

Unedited 08082023

Spoken Word	SignWriting
soon	
soon	
soon	



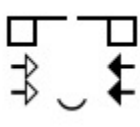



American Sign Language (ASL) Dictionary

Unedited 08082023

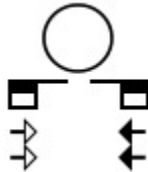
Spoken Word	SignWriting
soothe	
Sophomore	
sophomore	
sophomore	
sophomore class	
sore	
sore	
sore throat	

American Sign Language (ASL) Dictionary

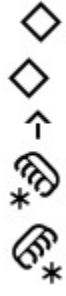
Unedited 08082023

Spoken Word	SignWriting
sore throat	
sorry	
sorry	
sorry	
sorry	
soul	
soul sucking	
sound	
sound	







American Sign Language (ASL) Dictionary

Unedited 08082023

Spoken Word	SignWriting
soup	
soup	
soup	
sour	
south	
south	
South Dakota	
South-Carolina	
South-Dakota	

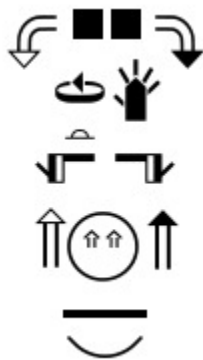

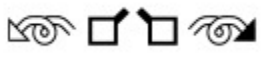



American Sign Language (ASL) Dictionary

Unedited 08082023

Spoken Word	SignWriting
South-Dakota	
space	
space	
spacestation	
spades	
spaghetti	
spaghetti	
spaghetti	



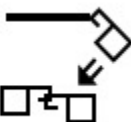

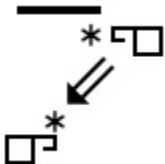
American Sign Language (ASL) Dictionary

Unedited 08082023

Spoken Word	SignWriting
spaghetti	
spaghetti	
spaghetti	
spaghetti	
Spain	
Spanish	
Spanish	
spanish	
Spanish Signs	



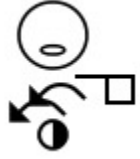

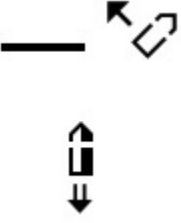
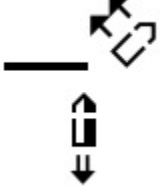
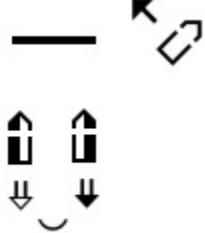
American Sign Language (ASL) Dictionary

Unedited 08082023

Spoken Word	SignWriting
speak	
speak	
speak	
speak	
speaker	
speaker	
speaker	

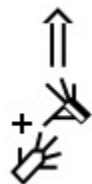

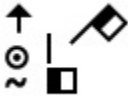
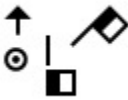
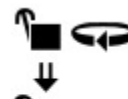
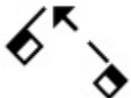



American Sign Language (ASL) Dictionary

Unedited 08082023

Spoken Word	SignWriting
special	
special	
specialist	
specialize	
specific	
specific	
speckled	
speech	

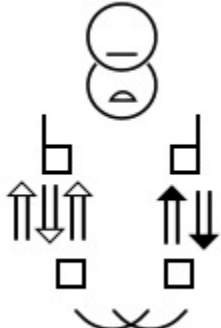

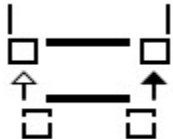



American Sign Language (ASL) Dictionary

Unedited 08082023

Spoken Word	SignWriting
speedometer	
spell-AM	
spell-PM	
spend	
spend	
spend	
spend all	
sphere	



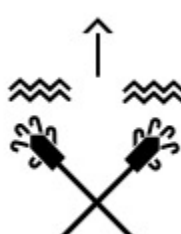

American Sign Language (ASL) Dictionary

Unedited 08082023

Spoken Word	SignWriting
spice	
spicy	
spicy	
spider	
spider	
spider crawling down	
spider wiggling down	



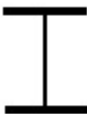
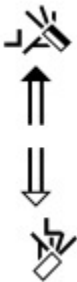

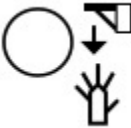

American Sign Language (ASL) Dictionary

Unedited 08082023

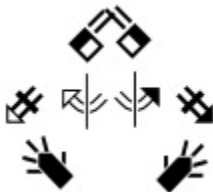
Spoken Word	SignWriting
Spiderman	
spinal undulation	
Spine extended	
spirit	
spirit	
spit	
splash	





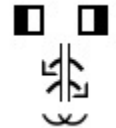

American Sign Language (ASL) Dictionary

Unedited 08082023

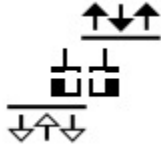
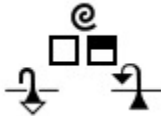
Spoken Word	SignWriting
splatter	
spoken	
Sponge	
spoon	
spoon	
spoon into a cup	
spoon-in-medicine	
sport	

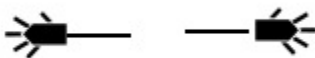

American Sign Language (ASL) Dictionary

Unedited 08082023

Spoken Word	SignWriting
sports	
sprain	
spread	
spread	
spread	
spread out	
spread on a surface	
spread on a surface	
spread-arms-out	







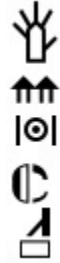

American Sign Language (ASL) Dictionary

Unedited 08082023

Spoken Word	SignWriting
spread-from-person	 <p>The SignWriting symbol consists of a face with a rightward arrow above it, a hand with fingers spread, and a rectangular box with an asterisk and a tilde symbol below it. A curved arrow indicates the hand moving from the face towards the box.</p>
spread-from-person	 <p>The SignWriting symbol consists of a face with a tilde symbol above it, a hand with fingers spread, and a rectangular box with an asterisk and a tilde symbol below it. A curved arrow indicates the hand moving from the face towards the box.</p>
Spring	 <p>The SignWriting symbol is a vertical sequence of four elements: a hand with fingers spread, a hand with fingers spread, a rectangular box with an asterisk and a tilde symbol, and a hand with fingers spread.</p>









American Sign Language (ASL) Dictionary

Unedited 08082023

Spoken Word	SignWriting
spring	
spring	
Springfield-Illinis	
sprinkle	
sprinkle on top	
square	
square	
square	







American Sign Language (ASL) Dictionary

Unedited 08082023

Spoken Word	SignWriting
squeeze	
squid	
squint	
squint with head turn	
squirrel	
squirrel	
squirrel	
squirrel	
SS	

American Sign Language (ASL) Dictionary

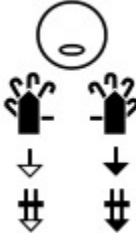
Unedited 08082023

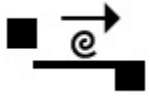
Spoken Word	SignWriting
SSI	
St. Patrick's Day	
St. Patrick's Day	
stab	
stadium	
staff	
staff	
Stage	







American Sign Language (ASL) Dictionary

Unedited 08082023

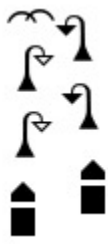
Spoken Word	SignWriting
stain	<p>The SignWriting for 'stain' consists of a hand icon on the left with a downward arrow, and a hand icon on the right with an upward arrow. A diamond shape is positioned below the right hand icon.</p>
stair	<p>The SignWriting for 'stair' features a hand icon on the left with a zigzag arrow pointing down, and a hand icon on the right with a downward arrow.</p>
stair	<p>The SignWriting for 'stair' features a hand icon on the left with a zigzag arrow pointing up, and a hand icon on the right with an upward arrow.</p>
stairs	<p>The SignWriting for 'stairs' shows two hand icons. The left hand icon has a zigzag arrow pointing down, and the right hand icon has a zigzag arrow pointing up. Below each hand icon is a small square.</p>
stairs	<p>The SignWriting for 'stairs' shows two hand icons. The left hand icon has a zigzag arrow pointing down, and the right hand icon has a zigzag arrow pointing up. Below each hand icon is a small square.</p>
stairs	<p>The SignWriting for 'stairs' shows two hand icons. The left hand icon has a zigzag arrow pointing down, and the right hand icon has a zigzag arrow pointing up. Below each hand icon is a small square.</p>







American Sign Language (ASL) Dictionary

Unedited 08082023

Spoken Word	SignWriting
stairway	
stairway	
stamp	
Stampede	
stand	
stand	
stand	



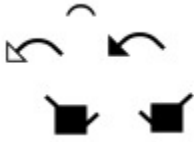
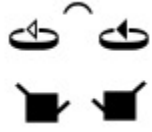
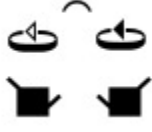

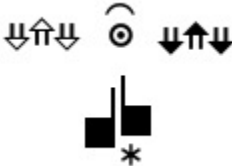

American Sign Language (ASL) Dictionary

Unedited 08082023

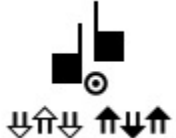
Spoken Word	SignWriting
stand before God	
stand-on-bar	
stand-on-head	
stand-up	
standard	
standard	
standardization	
standardization	
star	

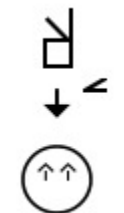

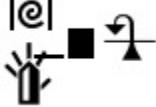





American Sign Language (ASL) Dictionary

Unedited 08082023

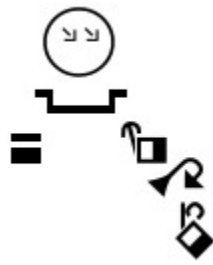
Spoken Word	SignWriting
star	
star	
stare	
stare	
start	
Start	
start	
start	



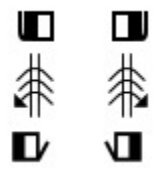

American Sign Language (ASL) Dictionary

Unedited 08082023

Spoken Word	SignWriting
start	
start	
start motorcycle	
state	
state	
statement	
station	
statue	
statue	

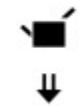
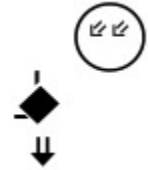
American Sign Language (ASL) Dictionary

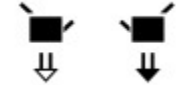
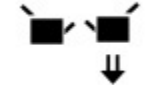
Unedited 08082023

Spoken Word	SignWriting
strawberry	
stay	
stay	
stay	
stay	
stay	
stay	
stay	





American Sign Language (ASL) Dictionary

Unedited 08082023

Spoken Word	SignWriting
stay awake all night	<p>The signwriting consists of a face with wide-open eyes, a bracket below it, a square, a vertical line with a horizontal tick, a tilde, and a hand with fingers spread.</p>
stay awake all night	<p>The signwriting consists of a face with wide-open eyes, a bracket below it, a square, a vertical line with a horizontal tick, a tilde, and a hand with fingers spread.</p>
stay-awake-all-night	<p>The signwriting consists of a face with closed eyes, a horizontal line with upward arrows at both ends, a square, a vertical line with a horizontal tick, a tilde, a hand with fingers spread, a square, a vertical line with a horizontal tick, a tilde, a hand with fingers spread, a face with wide-open eyes, a bracket below it, a square, a vertical line with a horizontal tick, a tilde, and a hand with fingers spread.</p>
steadfast	<p>The signwriting consists of a circle, a horizontal line with two squares at each end, and a hand with fingers spread.</p>
steady	<p>The signwriting consists of two squares side-by-side with a tilde below them, and a star below that.</p>
steady	<p>The signwriting consists of two upward arrows above two squares side-by-side.</p>

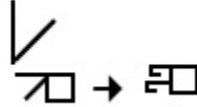
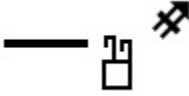
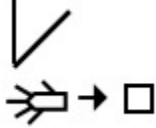
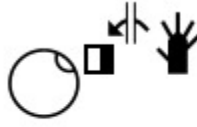





American Sign Language (ASL) Dictionary

Unedited 08082023

Spoken Word	SignWriting
steal	
steal	
steal	
steal	
Stefan	
step-on-creature	 
stepfather	 

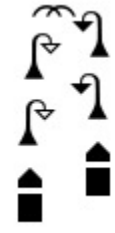

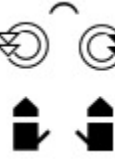

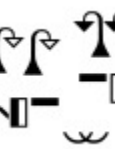

American Sign Language (ASL) Dictionary

Unedited 08082023

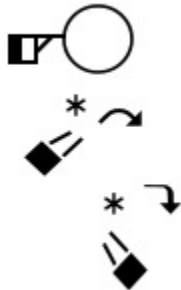
Spoken Word	SignWriting
stepmother	 
steps	
steps	
steps	
steps	
steps-in-process	

American Sign Language (ASL) Dictionary

Unedited 08082023

Spoken Word	SignWriting
stereo	
Stethoscope	
Steve	
Steve Slevinski	
stick	
stick to mind	
sticky	
sticky	





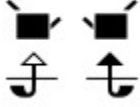

American Sign Language (ASL) Dictionary

Unedited 08082023

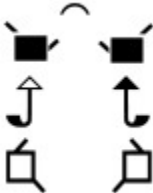
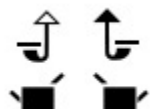
Spoken Word	SignWriting
still	







American Sign Language (ASL) Dictionary

Unedited 08082023

Spoken Word	SignWriting
still	
still	
still	
stimulus	
stingray	
stink	
stir	
stir	
stockings	

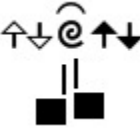

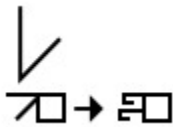
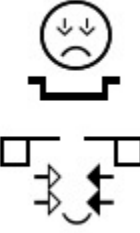





American Sign Language (ASL) Dictionary

Unedited 08082023

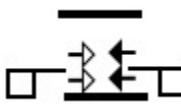
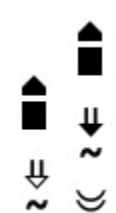
Spoken Word	SignWriting
stockings	
stockings	
stockings	
stolen	
stolen	
stomach ache	
stomach ache	





American Sign Language (ASL) Dictionary

Unedited 08082023

Spoken Word	SignWriting
stomach area	
stomach turn	
stomachache	
stomp	
stone	
stone	
stone	
stop	
stop	

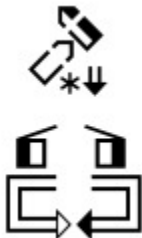



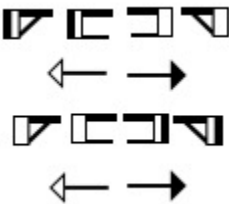
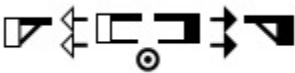
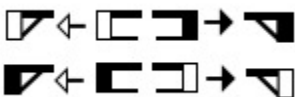

American Sign Language (ASL) Dictionary

Unedited 08082023

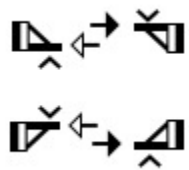
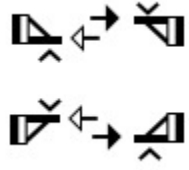
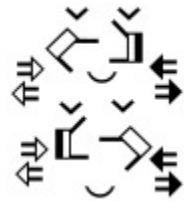
Spoken Word	SignWriting
stop	
stop sign	
stop-it	
store	
story	
story	
story	
story	





American Sign Language (ASL) Dictionary

Unedited 08082023

Spoken Word	SignWriting
story	
story	
story	
story	
straight	
straight	
straight	
straightforward	



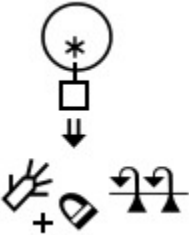
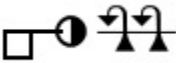
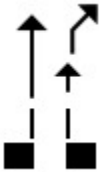

American Sign Language (ASL) Dictionary

Unedited 08082023

Spoken Word	SignWriting
strainer	
strange	
straw	
strawberry	
strawberry	
strawberry	
stray	

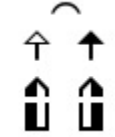

American Sign Language (ASL) Dictionary

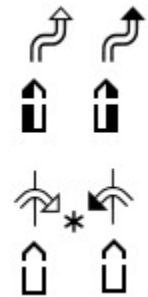
Unedited 08082023

Spoken Word	SignWriting
stream	
stream	
street	
street cleaner	
street closed	



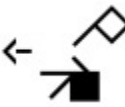
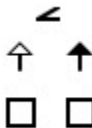

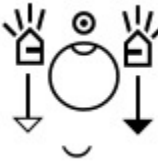
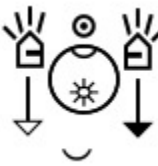
American Sign Language (ASL) Dictionary

Unedited 08082023

Spoken Word	SignWriting
street ends	
streetcar	
strength	
stress	
stress	
stressed out	
stressed out	

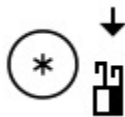
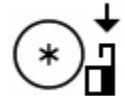
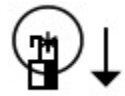
American Sign Language (ASL) Dictionary

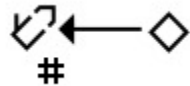
Unedited 08082023

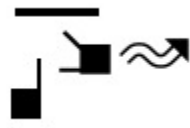
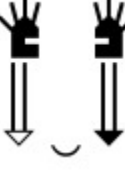
Spoken Word	SignWriting
strict	
strict	
strict	
strike	#
strike-match	
strike-palm	
string	
strip	
stripe-horizontal	
stripes	





American Sign Language (ASL) Dictionary

Unedited 08082023

Spoken Word	SignWriting
stripes	
stripes-wide	
stroke	
stroke	
stroke	
stroll	
strong	
strong	

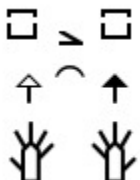

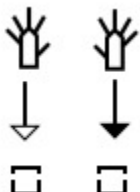
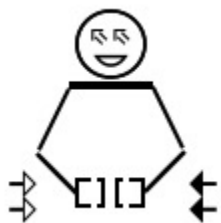
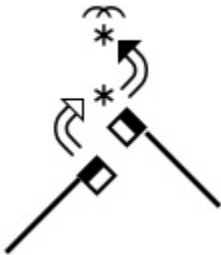

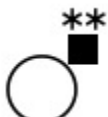



American Sign Language (ASL) Dictionary

Unedited 08082023

Spoken Word	SignWriting
strong	
strong	
strong	
strong-man	
structure	
Stuart	
Stuart	



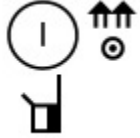

American Sign Language (ASL) Dictionary

Unedited 08082023

Spoken Word	SignWriting
stubborn	
stubborn	
stubborn	
stuck	
stuck	
stuck	
stuck problem	
stuck up	
STUDENT	

American Sign Language (ASL) Dictionary

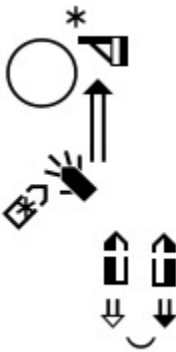
Unedited 08082023

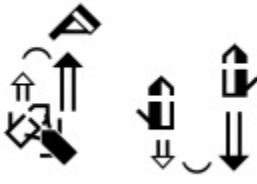
Spoken Word	SignWriting
student	
student	
student	
student	
student	
student	





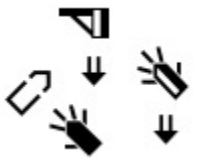

American Sign Language (ASL) Dictionary

Unedited 08082023

Spoken Word	SignWriting
student	 The SignWriting for 'student' consists of several symbols: a hand with fingers spread, a hand with fingers spread and a downward arrow, a hand with fingers spread and a downward arrow, a hand with fingers spread and a downward arrow, and a hand with fingers spread and a downward arrow.

American Sign Language (ASL) Dictionary

Unedited 08082023

Spoken Word	SignWriting
student	
student	
STUDENT2	
study	
study	
stupid	

American Sign Language (ASL) Dictionary

Unedited 08082023

Spoken Word	SignWriting
stupidly follow	<p>The signwriting for 'stupidly follow' consists of a circle with a downward arrow, followed by a sequence of three hand shapes. Each hand shape is a square with a vertical line on the right side and a curved arrow pointing from the top to the bottom of the line.</p>
style	<p>The signwriting for 'style' shows two hands with fingers spread, moving towards each other. In the center, there is a curved arrow pointing upwards and a small asterisk.</p>
style-lex	<p>The signwriting for 'style-lex' features a central circle with a curved arrow pointing clockwise, surrounded by several solid black squares.</p>
subdue	<p>The signwriting for 'subdue' shows a hand shape with a curved arrow pointing downwards, positioned above a solid black square.</p>
subject	<p>The signwriting for 'subject' includes a horizontal line at the top, followed by two solid black squares. Below these are two asterisks, a downward arrow, and a curved arrow.</p>
sublimation	<p>The signwriting for 'sublimation' shows a hand shape with a curved arrow pointing upwards, positioned above a solid black square. Below this is another solid black square with an asterisk.</p>



American Sign Language (ASL) Dictionary

Unedited 08082023

Spoken Word	SignWriting
submissive	<p>The signwriting for 'submissive' consists of two hand icons. The first hand is open with fingers spread, moving down. The second hand is also open with fingers spread, moving down. Below these are two sets of arrows pointing down, a crescent moon, and two diamond shapes pointing down. At the bottom are two pairs of asterisks (**).</p>
subscribe	<p>The signwriting for 'subscribe' shows a hand icon with fingers spread, moving down. Below it is a diamond shape pointing down, followed by another hand icon with fingers spread, moving down. At the bottom is a diamond shape pointing down.</p>
subtract	<p>The signwriting for 'subtract' features a hand icon with fingers spread, moving down. Below it is a diamond shape pointing down, followed by a circle with a dot inside, and a diamond shape pointing down.</p>
subtract, deduct	<p>The signwriting for 'subtract, deduct' shows a hand icon with fingers spread, moving down. Below it is a diamond shape pointing down, followed by a circle with a dot inside, and a diamond shape pointing down.</p>
subway	<p>The signwriting for 'subway' includes a hand icon with fingers spread, moving down. Below it is a diamond shape pointing down, followed by a circle with a dot inside, and a diamond shape pointing down.</p>
success	<p>The signwriting for 'success' shows a hand icon with fingers spread, moving down. Below it is a diamond shape pointing down, followed by a circle with a dot inside, and a diamond shape pointing down.</p>
success	<p>The signwriting for 'success' features a hand icon with fingers spread, moving down. Below it is a diamond shape pointing down, followed by a circle with a dot inside, and a diamond shape pointing down.</p>



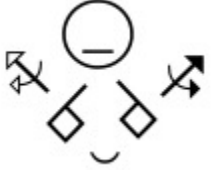
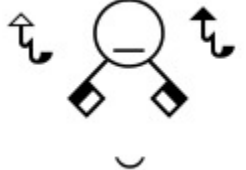
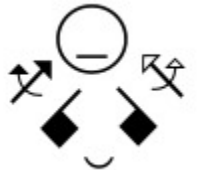
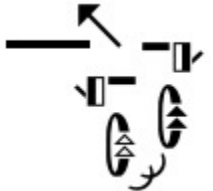
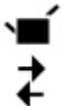
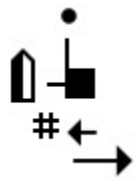

American Sign Language (ASL) Dictionary

Unedited 08082023

Spoken Word	SignWriting
success	
success	
success	
succession	
such	
suddenly	
suffer	

American Sign Language (ASL) Dictionary

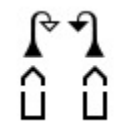
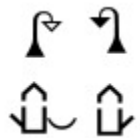
Unedited 08082023

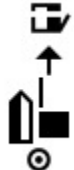
Spoken Word	SignWriting
sugar	
sugar	
suggest	
suggest	
suggestions	
suicide	
suicide	









American Sign Language (ASL) Dictionary

Unedited 08082023

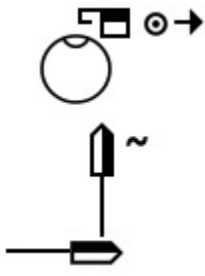
Spoken Word	SignWriting
suit	<p>The sign for 'suit' is represented by a vertical sequence of four black squares. The top square is solid black. The second square has a horizontal line extending to the right from its top edge. The third square has a horizontal line extending to the right from its top edge and a small triangle pointing to the right from its right edge. The bottom square is solid black.</p>
summarize	<p>The sign for 'summarize' is represented by a sequence of three elements: a hand symbol with fingers spread pointing right, followed by a square with a horizontal line extending to the right from its top edge, and another hand symbol with fingers spread pointing right.</p>
summary	<p>The sign for 'summary' is represented by a sequence of three elements: a hand symbol with fingers spread pointing right, followed by a square with a horizontal line extending to the right from its top edge and a small asterisk to its right, and another hand symbol with fingers spread pointing right.</p>
summary	<p>The sign for 'summary' is represented by a sequence of three elements: a hand symbol with fingers spread and a wavy line above it pointing right, followed by a square with a horizontal line extending to the right from its top edge and a small asterisk to its right, and another hand symbol with fingers spread and a wavy line above it pointing right.</p>
summary	<p>The sign for 'summary' is represented by a sequence of three elements: a hand symbol with fingers spread and a wavy line above it pointing right, followed by a square with a horizontal line extending to the right from its top edge and a small asterisk to its right, and another hand symbol with fingers spread and a wavy line above it pointing right.</p>
summer	<p>The sign for 'summer' is represented by a sequence of four elements: a circle, a square with a horizontal line extending to the right from its top edge, a small circle with a dot in the center, and another square with a horizontal line extending to the right from its top edge.</p>
summer	<p>The sign for 'summer' is represented by a sequence of four elements: a circle with a small asterisk above it, a square with a horizontal line extending to the right from its top edge, a small circle with a dot in the center, and another square with a horizontal line extending to the right from its top edge.</p>
summer	<p>The sign for 'summer' is represented by a sequence of four elements: a circle with a small horizontal line above it, a square with a horizontal line extending to the right from its top edge, a small circle with a dot in the center, and another square with a horizontal line extending to the right from its top edge.</p>
Summer	<p>The sign for 'Summer' is represented by a sequence of four elements: a circle with a small horizontal line above it, a square with a horizontal line extending to the right from its top edge, a small circle with a dot in the center, and another square with a horizontal line extending to the right from its top edge.</p>









American Sign Language (ASL) Dictionary

Unedited 08082023

Spoken Word	SignWriting
Summer	
Summer Institute of Linguistics	
summer solstice	
summon	
summon	
summon-to-me	
sun	
sun	

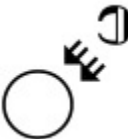
American Sign Language (ASL) Dictionary

Unedited 08082023

Spoken Word	SignWriting
sun	
sun	
sun	
sun	
sun	
sun rays set	
sunbathe	
sunbathe	



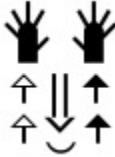
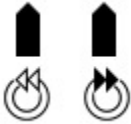
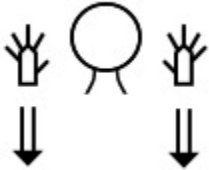
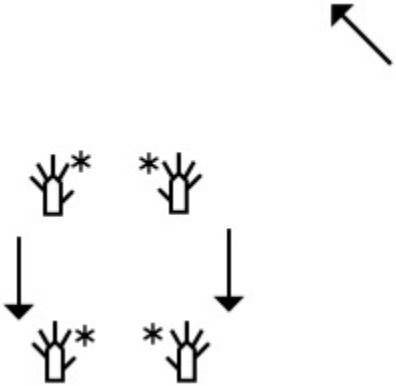
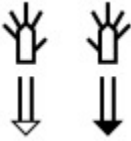

American Sign Language (ASL) Dictionary

Unedited 08082023

Spoken Word	SignWriting
Sunday	
Sunday	
Sunday	
Sunday	
Sunday	
Sundays	

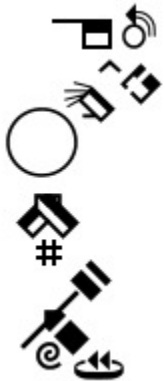

American Sign Language (ASL) Dictionary

Unedited 08082023

Spoken Word	SignWriting
sunny - extreme	
sunrise	
sunrise	
sunrise	
sunrise on the left	
sunscreen	

American Sign Language (ASL) Dictionary

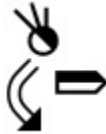
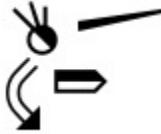
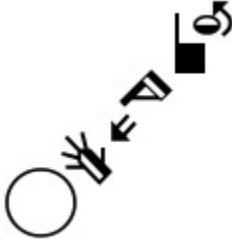
Unedited 08082023

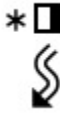
Spoken Word	SignWriting
sunset	
sunset	
sunset on the left	
sunshine	
Sup-	
superior	
superman	

American Sign Language (ASL) Dictionary

Unedited 08082023

Spoken Word	SignWriting
superstitious	<p>The SignWriting for 'superstitious' consists of a central circle with an upward-pointing arrow. Above the circle are two small squares, one on each side, with curved arrows pointing towards the center. Below the circle are three circles, each containing a pair of arrows: the left one has two left-pointing arrows, the middle one has two up-pointing arrows, and the right one has two right-pointing arrows.</p>
supervise	<p>The SignWriting for 'supervise' features a central square with a downward-pointing arrow. To the left and right of the square are two small squares, each with a downward-pointing arrow. Below the central square is a circle containing two upward-pointing arrows.</p>
support	<p>The SignWriting for 'support' shows a central square with a downward-pointing arrow. To the left of the square is a small square with an asterisk. Below the central square is a curved arrow pointing to the right.</p>
support	<p>The SignWriting for 'support' shows a central square with a downward-pointing arrow. To the left of the square is a small square with an asterisk. Below the central square is a curved arrow pointing to the right.</p>
support	<p>The SignWriting for 'support' consists of two squares stacked vertically. Below the bottom square are two asterisks, and below the asterisks are two upward-pointing arrows.</p>
suppose	<p>The SignWriting for 'suppose' features a circle with a downward-pointing arrow. To the right of the circle are two asterisks and a small square.</p>
suppose	<p>The SignWriting for 'suppose' features a circle with a downward-pointing arrow. To the right of the circle are two asterisks and a small square. There are also two small upward-pointing arrows on the left side of the circle.</p>
suppose	<p>The SignWriting for 'suppose' features a circle with a downward-pointing arrow. To the right of the circle is a small square with an upward-pointing arrow.</p>







American Sign Language (ASL) Dictionary

Unedited 08082023

Spoken Word	SignWriting
suppress	<p>The signwriting for 'suppress' consists of a face with a downward-curving mouth, followed by a downward-pointing hand, and then two hands with fingers spread, one above the other.</p>
suppressed	<p>The signwriting for 'suppressed' consists of a face with a downward-curving mouth, followed by a bracket-like shape, then two hands with fingers spread, and finally a downward-pointing hand.</p>
supreme	<p>The signwriting for 'supreme' consists of a hand with fingers spread, moving upwards and then curving to the right.</p>
supreme	<p>The signwriting for 'supreme' consists of a hand with fingers spread, moving upwards and then to the right, with an asterisk and an upward-pointing arrow above it.</p>
suprise	<p>The signwriting for 'suprise' consists of a hand with fingers spread, moving upwards and then to the right, followed by a circle with a hand inside it, and then a hand with fingers spread, moving upwards and then to the right.</p>
sure	<p>The signwriting for 'sure' consists of a hand with fingers spread, moving upwards and then to the right, followed by a circle with a hand inside it.</p>
surf	<p>The signwriting for 'surf' consists of a hand with fingers spread, moving upwards and then to the right, followed by a hand with fingers spread, moving upwards and then to the right, and finally a hand with fingers spread, moving upwards and then to the right.</p>



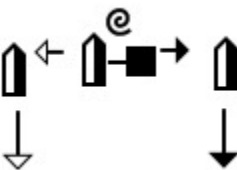





American Sign Language (ASL) Dictionary

Unedited 08082023

Spoken Word	SignWriting
surf	
surface (flat)	
surface of globe	
Surface Symbol Above	
surface water	
surgeon	
surgery	
surprise	



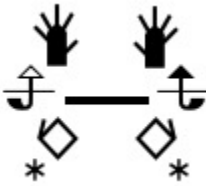



American Sign Language (ASL) Dictionary

Unedited 08082023

Spoken Word	SignWriting
surprise	
surprise	
surprise	
surprise	
surprised	
surreal	
surrender	
surrender	
surround	

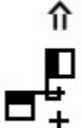
American Sign Language (ASL) Dictionary

Unedited 08082023

Spoken Word	SignWriting
sushi rolls	
suspect	
suspend	
Sutton	
swallow	
swallow	

American Sign Language (ASL) Dictionary

Unedited 08082023

Spoken Word	SignWriting
swamp	<p>The sign for 'swamp' is composed of several elements: a circle with a downward arrow and an asterisk, two hand icons with downward arrows, a U-shaped arrow, a tree icon, and a hand icon with a downward arrow and an asterisk.</p>
swan	<p>The sign for 'swan' consists of a hand icon with an upward arrow, a vertical line, and a hand icon with a downward arrow.</p>
swe	<p>The sign for 'swe' consists of two hand icons with downward arrows, each with a squiggly line above it, and a U-shaped arrow between them.</p>
swe	<p>The sign for 'swe' consists of two hand icons with downward arrows, each with a squiggly line above it, and a U-shaped arrow between them.</p>
sweat	<p>The sign for 'sweat' consists of two hand icons with downward arrows, a central face icon with a squiggly line above it, and a U-shaped arrow between the hands.</p>
sweater	<p>The sign for 'sweater' consists of two hand icons with downward arrows, a central 'e' symbol, and a U-shaped arrow between the hands.</p>









American Sign Language (ASL) Dictionary

Unedited 08082023

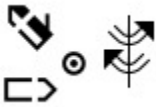
Spoken Word	SignWriting
sweater	
sweater	
Sweden	
Sweden	
Sweden	
Swedish	
sweep	







American Sign Language (ASL) Dictionary

Unedited 08082023

Spoken Word	SignWriting
sweep	
sweep	
sweep	
sweet	
sweet	
sweet	
sweet	
sweet	



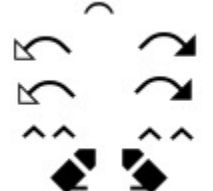

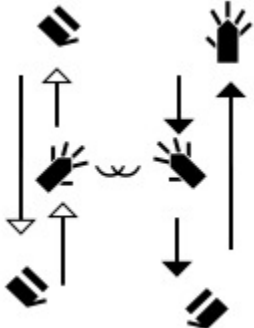

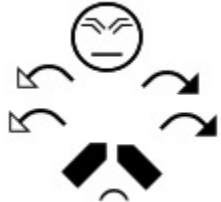

American Sign Language (ASL) Dictionary

Unedited 08082023

Spoken Word	SignWriting
sweetheart	
sweetheat	
swim	
swim	
swim	
swim	
swim	

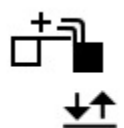







American Sign Language (ASL) Dictionary

Unedited 08082023

Spoken Word	SignWriting
swim	
swim-hard	
swindle	
Swing	
swing	
swing	
swing	
swing	
swing-baseball-bat	



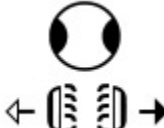

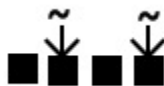
American Sign Language (ASL) Dictionary

Unedited 08082023

Spoken Word	SignWriting
swipe credit card	
Swiss	
Swiss	
Switzerland	
SWML	
swollen	
swollen	
sword	
SWSW	

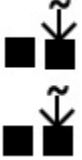
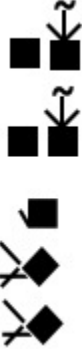
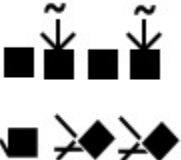



American Sign Language (ASL) Dictionary

Unedited 08082023

Spoken Word	SignWriting
SWSW	
SWSW App	
SWSW App	
Sydnie J	
symbiosis	
symbol	
Symbol-Palette	

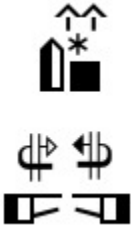



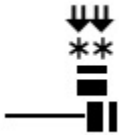
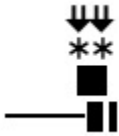
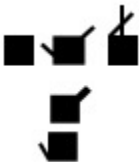

American Sign Language (ASL) Dictionary

Unedited 08082023

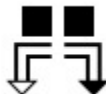
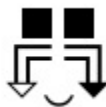
Spoken Word	SignWriting
Symbol-Palette	
Symbol-Palette	
symbols	
symbols	
synagogue	
synagogue	
Syria	



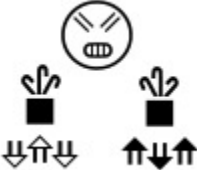
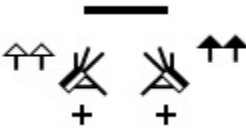
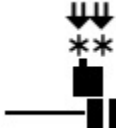



American Sign Language (ASL) Dictionary

Unedited 08082023

Spoken Word	SignWriting
syrup	
system	
system	
T	
T - receptive	
T O L O W S	
t-rex	
t-shirt	
tabernacle	
table	

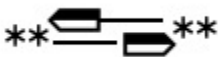

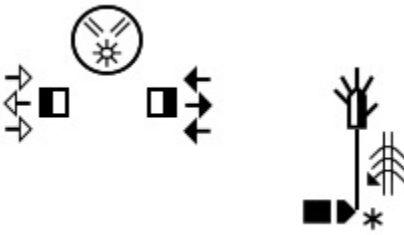



American Sign Language (ASL) Dictionary

Unedited 08082023

Spoken Word	SignWriting
table	
table	
table	
table	
table	
table lamp	
taiga	
tail	
Taiwan	









American Sign Language (ASL) Dictionary

Unedited 08082023

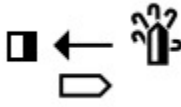
Spoken Word	SignWriting
Taiwan	
Taiwan	
Taiwan	
Taiwan	
Taiwanese	
take	

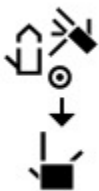

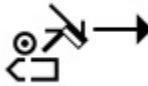



American Sign Language (ASL) Dictionary

Unedited 08082023

Spoken Word	SignWriting
take	
take a bow	
take a chance	
take a picture	
take advantage	
take advantage of	
take advantage of	
take care	





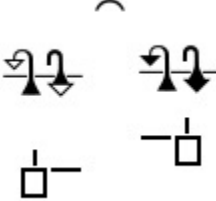

American Sign Language (ASL) Dictionary

Unedited 08082023

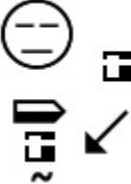
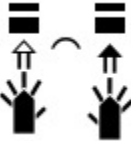
Spoken Word	SignWriting
take class	
take it easy	
take off	
take-care	
take-from-me	
take-place	
take-turns	

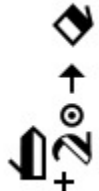





American Sign Language (ASL) Dictionary

Unedited 08082023

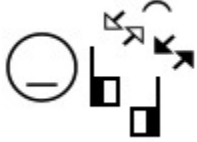
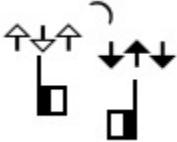
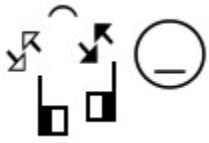
Spoken Word	SignWriting
take-turns	
take-under-place	
takeclass	
talent	
talent	
talk	
talk	
talk	





American Sign Language (ASL) Dictionary

Unedited 08082023

Spoken Word	SignWriting
talk	
talk	
talk	
talk	
talk	
talk	
talkative	
tall	



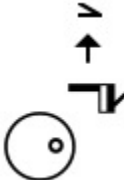

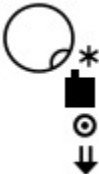
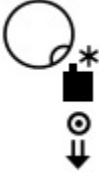

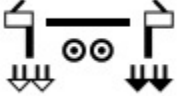

American Sign Language (ASL) Dictionary

Unedited 08082023

Spoken Word	SignWriting
tall	
tall	
tall	
tall	
tall	
tambourine	
tan	
tan	

American Sign Language (ASL) Dictionary

Unedited 08082023

Spoken Word	SignWriting
tank top	
tantrum	
tap-foot	
Tape Player	
tassel	 
taste	
taste	







American Sign Language (ASL) Dictionary

Unedited 08082023

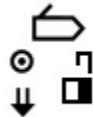
Spoken Word	SignWriting
tattle	<p>The SignWriting for 'tattle' consists of a vertical line with a small horizontal bar at the top, a solid black square below it, an upward-pointing arrow, a circle with a smaller circle inside, and another solid black square at the bottom.</p>
tattle-tale	<p>The SignWriting for 'tattle-tale' consists of a circle with a smaller circle inside, a solid black square below it, and a cluster of three smaller circles to the right of the square.</p>
tattoo artist	<p>The SignWriting for 'tattoo artist' is a vertical sequence of four symbols: a circle with a hand icon to its right, two hands with an asterisk between them, a sun-like symbol with rays and a vertical line extending downwards, and two vertical bars with arrows pointing up and down.</p>
tattoo artist	<p>The SignWriting for 'tattoo artist' is a vertical sequence of four symbols: a circle with a hand icon to its right, two hands with an asterisk between them, a sun-like symbol with rays and a vertical line extending downwards, and two vertical bars with arrows pointing up and down.</p>



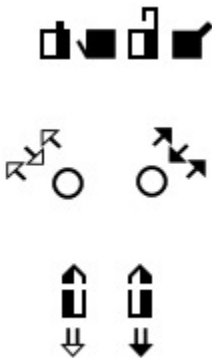
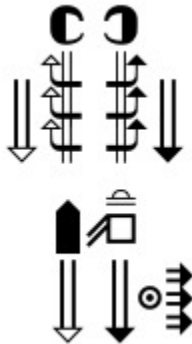



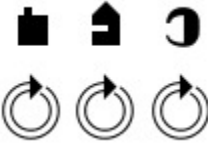

American Sign Language (ASL) Dictionary

Unedited 08082023

Spoken Word	SignWriting
tax	
tax	
taxi	
taxi	
taxi driver	
taxonomy	
Taz	

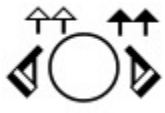

American Sign Language (ASL) Dictionary

Unedited 08082023

Spoken Word	SignWriting
TBC	
tea	
tea	
tea	
teach	
teach	
teach	
teach	
teach	

American Sign Language (ASL) Dictionary

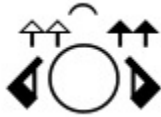
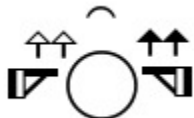
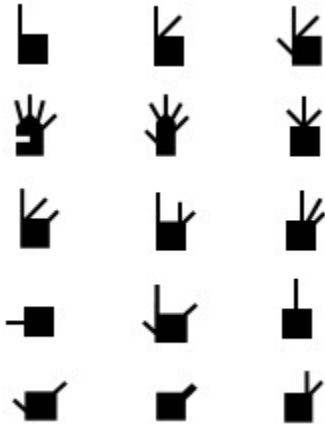
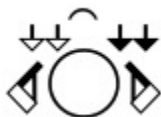
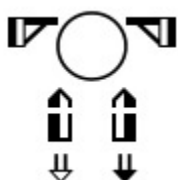
Unedited 08082023

Spoken Word	SignWriting
teach	
teach	
Teach Fingers	
teach-me	
teacher	
teacher	







American Sign Language (ASL) Dictionary

Unedited 08082023

Spoken Word	SignWriting
teacher	<p>The SignWriting symbol for 'teacher' (ASL 1) consists of a central circle. Above the circle are two upward-pointing arrows. On the left and right sides of the circle are two trapezoidal shapes pointing outwards. Below the circle are two downward-pointing arrows, and a small crescent moon is positioned between them.</p>
teacher	<p>The SignWriting symbol for 'teacher' (ASL 2) consists of a central circle. On the left and right sides of the circle are two trapezoidal shapes pointing outwards. Below the circle are two downward-pointing arrows, and a small crescent moon is positioned between them. Above the circle are two hand shapes with fingers spread, pointing downwards.</p>
teacher_3	<p>The SignWriting symbol for 'teacher_3' (ASL 3) consists of a central circle. On the left and right sides of the circle are two trapezoidal shapes pointing outwards. Above the circle are two upward-pointing arrows, and a small crescent moon is positioned between them. Below the circle are two downward-pointing arrows, and a small crescent moon is positioned between them.</p>
team	<p>The SignWriting symbol for 'team' (ASL 4) consists of two squares at the top, with an asterisk above them. Below the squares are two curved arrows pointing towards each other. At the bottom are two solid black squares.</p>
team	<p>The SignWriting symbol for 'team' (ASL 5) consists of two squares at the top, with a double-headed arrow above them. Below the squares are two solid black squares.</p>
team	<p>The SignWriting symbol for 'team' (ASL 6) consists of two squares at the top, with a double-headed arrow above them. Below the squares are two solid black squares.</p>

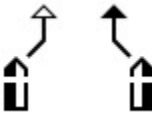
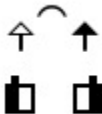
American Sign Language (ASL) Dictionary

Unedited 08082023

Spoken Word	SignWriting
tear down	
technical	
technique	
technique	
technology	
teen	
teeth	
teeth	





American Sign Language (ASL) Dictionary

Unedited 08082023

Spoken Word	SignWriting
Teeth chattering on a bumpy ride	<p>The signwriting consists of a circle containing a mouth with teeth, positioned above a stylized figure of a person. Below the figure are three vertical arrows pointing up and down, indicating a bumpy ride.</p>
teeth chew	<p>The signwriting is a circle containing a mouth with teeth and a wavy line below it, representing the action of chewing.</p>
telegram	<p>The signwriting shows a hand holding a rectangular object (a telegram) with a curved arrow pointing upwards from the top right corner, indicating the action of sending or receiving a telegram.</p>
telegraph	<p>The signwriting depicts a hand holding a vertical rectangular object (a telegraph key) with a curved arrow pointing upwards from the top right corner. Below the object are three asterisks (***) indicating a specific sign.</p>
telephone	<p>The signwriting shows a circle representing a telephone receiver, with a small square representing the handset. Two asterisks (**) are placed above the handset.</p>
telephone	<p>The signwriting shows a circle representing a telephone receiver, with a small square representing the handset. An arrow points from the handset towards the receiver.</p>
telephone	<p>The signwriting shows a circle representing a telephone receiver, with a small square representing the handset. Two asterisks (**) are placed above the handset, and an arrow points from the handset towards the receiver.</p>
telescope	<p>The signwriting shows a circle representing the objective lens of a telescope, with a smaller circle representing the eyepiece. An arrow points from the eyepiece towards the objective lens.</p>
tell	<p>The signwriting shows a circle representing a mouth, with a small square below it representing a hand. An arrow points from the hand towards the mouth.</p>

American Sign Language (ASL) Dictionary

Unedited 08082023

Spoken Word	SignWriting
tell	
tell	
tell	
tell	
tell	





American Sign Language (ASL) Dictionary

Unedited 08082023

Spoken Word	SignWriting
tell	A circle with a vertical line extending downwards to a square. A small asterisk is to the left of the vertical line. An upward-pointing arrow is to the right of the square.
tell	A circle with a vertical line extending downwards to a square. A curved arrow points from the square to the right.
tell (v) I tell you.	A circle with a vertical line extending downwards to a square. A small asterisk is to the left of the vertical line. An upward-pointing arrow is to the right of the square.
tell everyone	A circle with a vertical line extending downwards to a square. A diamond is to the right of the vertical line. A curved arrow points from the square to the left. Another curved arrow points from the square to the right.
tell me	A circle with a vertical line extending downwards to a square. Two downward-pointing arrows are to the right of the square. A small asterisk is below the square.
tell me	A circle with a vertical line extending downwards to a square. A curved arrow points from the square to the right.
tell you	A circle with a vertical line extending downwards to a square. A small asterisk is to the left of the vertical line. An upward-pointing arrow is to the right of the square.



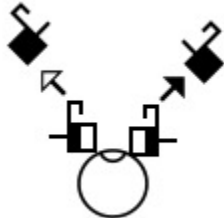

American Sign Language (ASL) Dictionary

Unedited 08082023

Spoken Word	SignWriting
tell-him	
tell-me	
tell-to-me	
temp	
temp	
temper	
temperate	
temperate forest	

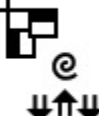
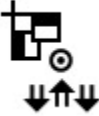

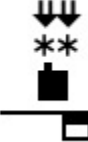
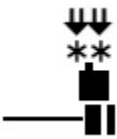
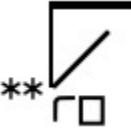



American Sign Language (ASL) Dictionary

Unedited 08082023

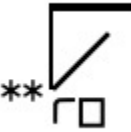
Spoken Word	SignWriting
temperature	
temperature	
temperature	
temple	
temple	
temple	
tempt	
tempt	

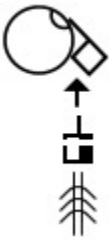
American Sign Language (ASL) Dictionary

Unedited 08082023

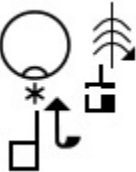
Spoken Word	SignWriting
temptation	
ten (receptive) (left hand)	
ten cents	
ten o'clock	
ten of us (left hand)	
ten of us (right hand)	
ten years old	







American Sign Language (ASL) Dictionary

Unedited 08082023

Spoken Word	SignWriting
ten years old	
tend	
tend	
tend	
tend	
tend to	
Tennessee	
Tennessee	
tennis	



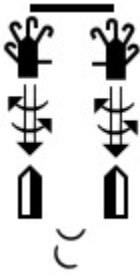



American Sign Language (ASL) Dictionary

Unedited 08082023

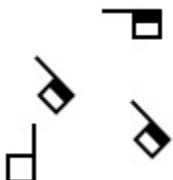
Spoken Word	SignWriting
tennis	
tennis	
tent	
tent	
terrible	
terrorist	
terr	

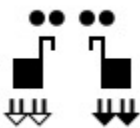
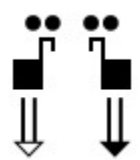
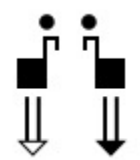
American Sign Language (ASL) Dictionary

Unedited 08082023

Spoken Word	SignWriting
Test	
test	
test	
test	
test	
test	
test again	
test apple	







American Sign Language (ASL) Dictionary

Unedited 08082023

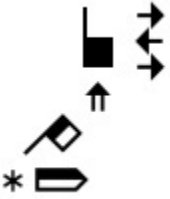
Spoken Word	SignWriting
test examples hands on top of each other	
Test Hinge Trill	
Test new	
Test new	
Test sequential finger movement	
test sequential flick	
test sequential hinge up	
test sequential hinge up	
test sequential squeeze	
test Squeeze-Flick-Trill	
test tube	
test zero	





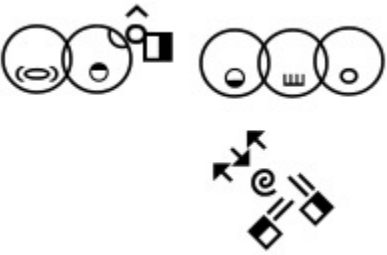



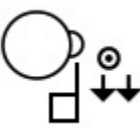

American Sign Language (ASL) Dictionary

Unedited 08082023

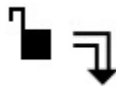
Spoken Word	SignWriting
test-oclock	
test6	
testament	
testify	
testing	
testtest	
testtest	
testtesttest	
testttt	

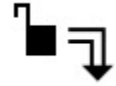





American Sign Language (ASL) Dictionary

Unedited 08082023

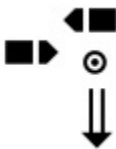
Spoken Word	SignWriting
testttttttttt	
testyyyyy	
testyyyyy	
tewwwww	
Texas	
Texas	
Texas	
texas	
text	
texting	



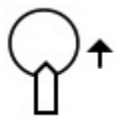



American Sign Language (ASL) Dictionary

Unedited 08082023

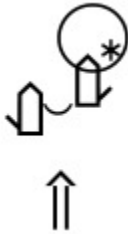
Spoken Word	SignWriting
Thailand	
Thailand country	
than	
thank you	
thank you	
Thank you AnnaGrace!	
Thank you!	
thank-you	
thank-you	





American Sign Language (ASL) Dictionary

Unedited 08082023

Spoken Word	SignWriting
thank-you	
thank-you	
thank-you	
thank_you	
thanks	
Thanksgiving	



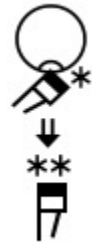
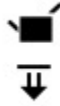
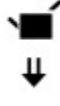





American Sign Language (ASL) Dictionary

Unedited 08082023

Spoken Word	SignWriting
Thanksgiving	
Thanksgiving	
Thanksgiving	
Thanksgiving	
that	
that	
that	
that	







American Sign Language (ASL) Dictionary

Unedited 08082023

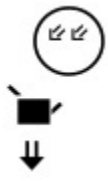
Spoken Word	SignWriting
that	
that	
that	
that	
that	
that	
that	
that affirmative	



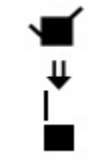







American Sign Language (ASL) Dictionary

Unedited 08082023

Spoken Word	SignWriting
that on left	
that on left	
that-eyegazeforward	
that-left	
that-left	
that-one	
that-right	
that-right	









American Sign Language (ASL) Dictionary

Unedited 08082023

Spoken Word	SignWriting
that-specific	
the	
the	
the	
the	
the	
the	
the	
the	
the (right-handed movement)	
The Cat is white	







American Sign Language (ASL) Dictionary

Unedited 08082023

Spoken Word	SignWriting
The cat is white.	
theater	
theater	
theater	
their	
their	
their	
their	
their left	





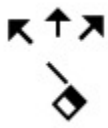
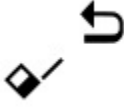

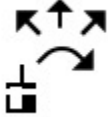

American Sign Language (ASL) Dictionary

Unedited 08082023

Spoken Word	SignWriting
their-all	
their-from-heaven	
their-left	
their-own	
theirs	
them	
them	
them	
them-right	



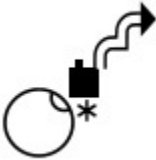
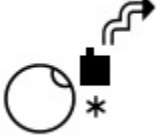
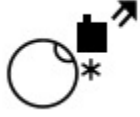







American Sign Language (ASL) Dictionary

Unedited 08082023

Spoken Word	SignWriting
themselves	
themselves	
themselves (to the left)	
then	
then	
theology	
theories	
theory	
theory	
therapy	

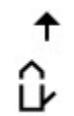
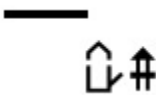





American Sign Language (ASL) Dictionary

Unedited 08082023

Spoken Word	SignWriting
therapy	
there	
there	
there	
there	
there	
there	
there	
there	
there	
there	

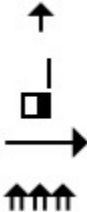
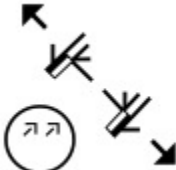

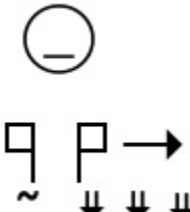

American Sign Language (ASL) Dictionary

Unedited 08082023

Spoken Word	SignWriting
there	
there	
there-3times	
THERE-IS-NO-GOD	
there-left	
there-right	
there-specific	
there-there	

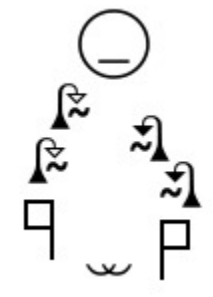
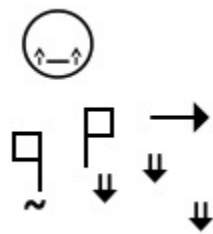



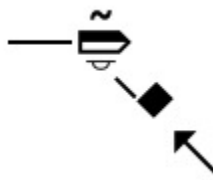
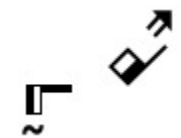

American Sign Language (ASL) Dictionary

Unedited 08082023

Spoken Word	SignWriting
there-there	
there-there	
there-to-the-left	
there-to-the-left (LEFT HAND)	
there-to-the-right	
there-to-the-right-LEFT	
there-under-cl-b	
there-up-right	





American Sign Language (ASL) Dictionary

Unedited 08082023

Spoken Word	SignWriting
there-up-right	
there-up-right	
therefore	
thesaurus	
these	
these	

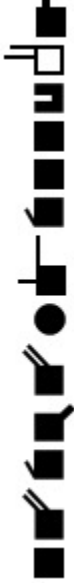

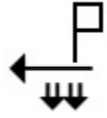



American Sign Language (ASL) Dictionary

Unedited 08082023

Spoken Word	SignWriting
<p>Thessalonians</p>	
<p>they</p>	
<p>they down there</p>	
<p>thibeault</p>	

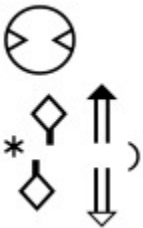

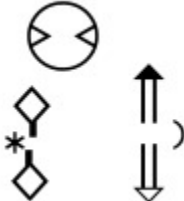

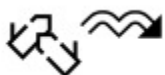

American Sign Language (ASL) Dictionary

Unedited 08082023

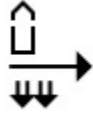
Spoken Word	SignWriting
thick	
thief	
thin	
thin	
thin	
thin	
thing	
thing	

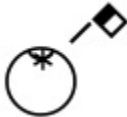
American Sign Language (ASL) Dictionary

Unedited 08082023

Spoken Word	SignWriting
things	
things	
Think	
think	
think	
think	
think same	
think-self	
think-to-oneself	









American Sign Language (ASL) Dictionary

Unedited 08082023

Spoken Word	SignWriting
think-to-oneself	
thinking	
thinner vertical cylinder	
thinner vertical cylinder	
third	
third of five	
third of three	
third-in-a-list	
thirdly	

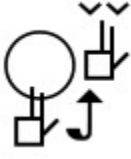







American Sign Language (ASL) Dictionary

Unedited 08082023

Spoken Word	SignWriting
Thirsty	
thirteen	
thirteen	
thirteen years old	
thirteen years old	
thirty	
thirty four years old	
this	









American Sign Language (ASL) Dictionary

Unedited 08082023

Spoken Word	SignWriting
this	
this	
this	
this	
this compared to this	
this here	
this one	
this one	
this one	



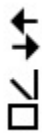





American Sign Language (ASL) Dictionary

Unedited 08082023

Spoken Word	SignWriting
this one	
this one	
this specifically	
thorn	
those	
those	
those	
those two	
those two	

American Sign Language (ASL) Dictionary

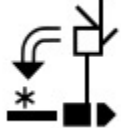
Unedited 08082023

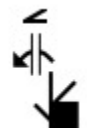
Spoken Word	SignWriting
those-2-above	
thought	
thousand	
thousand	
thousand	
thousand	
Three	
three days	
three days ago	
three dimension	
three dollars	







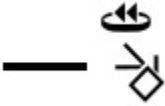

American Sign Language (ASL) Dictionary

Unedited 08082023

Spoken Word	SignWriting
three hours	
three hundred	
three minutes	
three month	
three months	
three o'clock	
three of us	
three of us	

American Sign Language (ASL) Dictionary

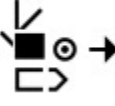
Unedited 08082023

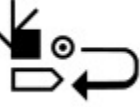
Spoken Word	SignWriting
three of us	
three of us	
three of us (left hand)	
three of us (right hand)	
three of you	
three travel	
three weeks	
three weeks	
three weeks ago	
three weeks ago	





American Sign Language (ASL) Dictionary

Unedited 08082023

Spoken Word	SignWriting
three years ago	The signwriting consists of a horizontal line at the top, a vertical line on the left, a square with an asterisk inside, and a downward-pointing arrow with a hook on its right side.
three years old	The signwriting features a circle at the top, a vertical line on the left, a square with an asterisk inside, and a downward-pointing arrow with a hook on its right side.
three years old	The signwriting features a circle at the top, a vertical line on the left, a square with an asterisk inside, and a curved arrow pointing upwards and to the right.
thrice	The signwriting includes a vertical line on the left, a square with an asterisk inside, and a downward-pointing arrow with a hook on its right side.
thrice	The signwriting includes a vertical line on the left, a square with an asterisk inside, a curved arrow pointing upwards and to the right, and a downward-pointing arrow with a hook on its right side.
thrill	The signwriting consists of a curved arrow pointing upwards and to the right, a vertical line on the left, a square with an asterisk inside, and a downward-pointing arrow with a hook on its right side.
throne	The signwriting features two upward-pointing arrows, a square with an asterisk inside, and two downward-pointing arrows.
through	The signwriting includes a vertical line on the left, a square with an asterisk inside, a downward-pointing arrow with a hook on its right side, and a curved arrow pointing upwards and to the right.

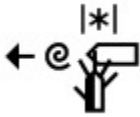

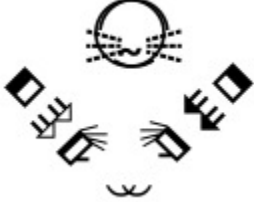

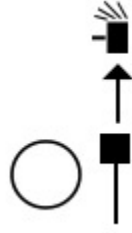
American Sign Language (ASL) Dictionary

Unedited 08082023

Spoken Word	SignWriting
through	
through	
throw	
throw	
throw	
throw	
throw	









American Sign Language (ASL) Dictionary

Unedited 08082023

Spoken Word	SignWriting
throw	
throw	
throw	
throw-out	





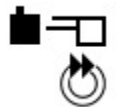



American Sign Language (ASL) Dictionary

Unedited 08082023

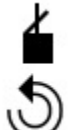
Spoken Word	SignWriting
throw-out	
thumbs down	
thumbs up	
thumbs up	
thumbs up	
thumbs up both hands	
thumbs-up-left	
thunder	
Thursday	



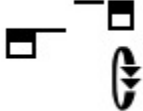



American Sign Language (ASL) Dictionary

Unedited 08082023

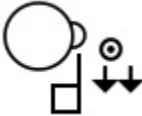
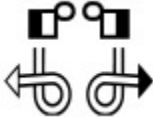
Spoken Word	SignWriting
Thursday	
Thursday	
Thursday	
Thursday	
Thursday	
Thursday	
tiara	
tick-tock	
ticket	

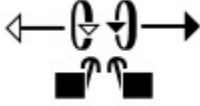





American Sign Language (ASL) Dictionary

Unedited 08082023

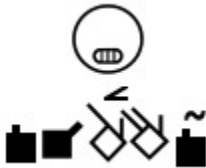
Spoken Word	SignWriting
ticket	
tickle-ear	
tie	
tie	
tie	
tie-a-bow	
Tiffany	
tiger	
tiger	

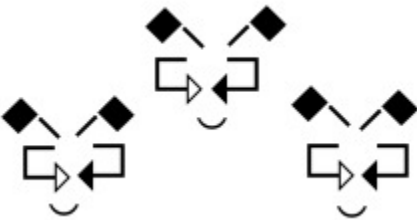



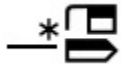

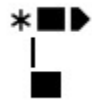

American Sign Language (ASL) Dictionary

Unedited 08082023

Spoken Word	SignWriting
tight clothing	
tight clothing	
tightly curled hair	
tile	
Tim-Albert	
time	
time	
time	
time	



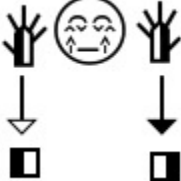





American Sign Language (ASL) Dictionary

Unedited 08082023

Spoken Word	SignWriting
time	
time	
time	
time	
time	
time	
time	
time flies	
time out	

American Sign Language (ASL) Dictionary

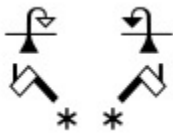
Unedited 08082023

Spoken Word	SignWriting
Timothy	
Tini	
tiny	
tiny	
tire	
tired	
tired	
tired	







American Sign Language (ASL) Dictionary

Unedited 08082023

Spoken Word	SignWriting
tired	<p>The SignWriting for 'tired' consists of a horizontal line at the top. Below it, there are two hand shapes, each with a downward-pointing arrow. In the center, there are two asterisks. At the bottom, there is a small upward-pointing arrow and a curved line.</p>
tissue	<p>The SignWriting for 'tissue' shows a hand shape with a downward-pointing arrow on the left, and a hand shape with a downward-pointing arrow on the right. A small circle with a dot inside is positioned between the two hands.</p>
tissue	<p>The SignWriting for 'tissue' shows a hand shape with a downward-pointing arrow on the left, and a hand shape with a downward-pointing arrow on the right. A small circle with a dot inside is positioned between the two hands, and a small asterisk is located above the left hand.</p>
title	<p>The SignWriting for 'title' consists of two hand shapes, each with a downward-pointing arrow. The hands are positioned on either side of a central vertical line.</p>
title	<p>The SignWriting for 'title' consists of two hand shapes, each with a downward-pointing arrow. The hands are positioned on either side of a central vertical line, with a small curved line between them.</p>
title-	<p>The SignWriting for 'title-' consists of two hand shapes, each with a downward-pointing arrow. The hands are positioned on either side of a central vertical line, with a small curved line between them.</p>
Titus	<p>The SignWriting for 'Titus' consists of two hand shapes, each with a downward-pointing arrow. The hands are positioned on either side of a central vertical line.</p>

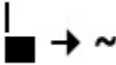
American Sign Language (ASL) Dictionary

Unedited 08082023

Spoken Word	SignWriting
Titus	
to	
to	
to	
to	
to	
to apply deodorant	
to apply makeup	

American Sign Language (ASL) Dictionary

Unedited 08082023

Spoken Word	SignWriting
to barely make ends meet	
to bite	
to blow dry hair	
to boast	
to brush one's teeth	
to clip finger nails	
to comb one's hair	
to floss	







American Sign Language (ASL) Dictionary

Unedited 08082023

Spoken Word	SignWriting
to grate food	<p>The SignWriting for 'to grate food' consists of four symbols arranged vertically. The first symbol is a circle with two short horizontal lines above it. The second symbol is a hand with fingers spread, with three asterisks below it and a wavy line to the right. The third symbol is a circle with two short horizontal lines below it. The fourth symbol is a hand with fingers spread, with two small circles below it and two downward-pointing arrows to the right.</p>
to have nothing	<p>The SignWriting for 'to have nothing' consists of two symbols arranged vertically. The first symbol is a circle with eight short lines radiating from its center. The second symbol is a square with an upward-pointing arrow on the left side and a downward-pointing arrow on the right side.</p>
To make payments	<p>The SignWriting for 'To make payments' consists of two symbols arranged horizontally. The first symbol is a circle with a jagged, sawtooth-like border. The second symbol is a square with a small circle to its right and a small square above it.</p>
to order	<p>The SignWriting for 'to order' consists of two symbols arranged horizontally. The first symbol is a circle with a vertical line extending downwards from its center to a square. The second symbol is a hand with fingers spread, with a small square above it and a small square to its right.</p>
to polish finger nails	<p>The SignWriting for 'to polish finger nails' consists of two symbols arranged horizontally. The first symbol is a hand with fingers spread, with a small square above it. The second symbol is a hand with fingers spread, with a small square above it and a small square to its right.</p>
to scrape	<p>The SignWriting for 'to scrape' consists of two symbols arranged horizontally. The first symbol is a square with an upward-pointing arrow on the left side and a downward-pointing arrow on the right side. The second symbol is a circle with two small circles below it.</p>
to shower	<p>The SignWriting for 'to shower' consists of two symbols arranged horizontally. The first symbol is a circle. The second symbol is a hand with fingers spread, with a diagonal arrow pointing downwards and to the right.</p>

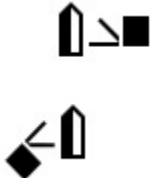
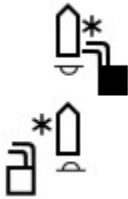
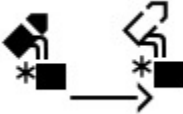

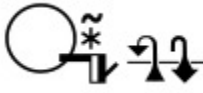
American Sign Language (ASL) Dictionary

Unedited 08082023

Spoken Word	SignWriting
to spray hair	
toad	
toast	
toast	
toast	
tobacco	
tobacco	
today	
today	



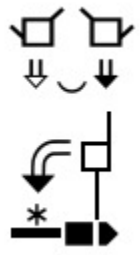
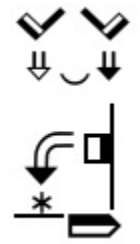
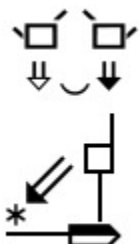



American Sign Language (ASL) Dictionary

Unedited 08082023

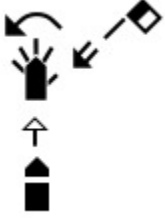
Spoken Word	SignWriting
today	
today	
today	
today	
today	
Today the weather is sunny	
Today the weather is sunny	
Today the weather is sunny.	



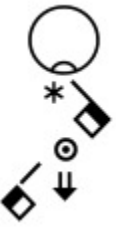

American Sign Language (ASL) Dictionary

Unedited 08082023

Spoken Word	SignWriting
toes	
together	
together	
toilet	
toilet	
tomato	
tomato	

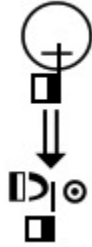
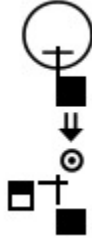
American Sign Language (ASL) Dictionary

Unedited 08082023

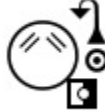
Spoken Word	SignWriting
tomato	
tomato	
tomorrow	
tomorrow	
tomorrow	
tomorrow	
tomorrow	







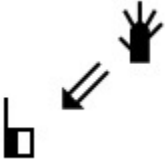

American Sign Language (ASL) Dictionary

Unedited 08082023

Spoken Word	SignWriting
tongues	<p>The signwriting for 'tongues' consists of a circle containing the number '1' on the left. To its right are two vertical hand shapes, each with a wavy line above it representing a tongue. Above these hand shapes are two upward-pointing arrows.</p>
tonight	<p>The signwriting for 'tonight' is composed of two parts. The top part shows two hand shapes with downward arrows, a curved line between them, and another downward arrow. The bottom part shows a hand shape with an asterisk, a horizontal line, and another hand shape with an asterisk.</p>
tonsils	<p>The signwriting for 'tonsils' features a central circle with two hand shapes on either side, each with a downward-pointing arrow.</p>
too	<p>The signwriting for 'too' includes a horizontal arrow pointing right at the top. Below it are two asterisks, and at the bottom are two solid black squares.</p>
too bad	<p>The signwriting for 'too bad' is a vertical sequence of symbols: a tilde (~), a hand shape with an upward arrow, another upward arrow, and a hand shape.</p>
too-late	<p>The signwriting for 'too-late' shows a hand shape with an asterisk and a downward arrow, followed by another hand shape with an asterisk and a downward arrow, and finally a hand shape with an upward arrow.</p>
tool	<p>The signwriting for 'tool' consists of a hand shape with an asterisk and a downward arrow, followed by a wavy line.</p>
toolbox	<p>The signwriting for 'toolbox' is a horizontal sequence of symbols: a solid black square, a circle, another circle, a hand shape with a vertical line, a hand shape with a vertical line, a circle, another circle, and a hand shape with a vertical line.</p>

American Sign Language (ASL) Dictionary

Unedited 08082023

Spoken Word	SignWriting
toople	
toothache	
toothbrush	
toothbrush	
toothpaste	
top	
top	
top - upper part	









American Sign Language (ASL) Dictionary

Unedited 08082023

Spoken Word	SignWriting
topic-pity-me	<p>The SignWriting for 'topic-pity-me' consists of a circle with two horizontal lines inside, followed by a hand with fingers spread, a hand with fingers curled, and another hand with fingers spread.</p>
Torah	<p>The SignWriting for 'Torah' features a central hand with fingers spread, flanked by two wavy lines, and two hands with fingers spread positioned below the central hand.</p>
Tornado	<p>The SignWriting for 'Tornado' includes a square with a vertical line extending upwards from its top center, and a spiral symbol with a downward-pointing arrow.</p>
Tornado	<p>The SignWriting for 'Tornado' is identical to the previous entry, showing a square with a vertical line and a downward-pointing spiral.</p>
tortilla	<p>The SignWriting for 'tortilla' consists of two sets of hand gestures. Each set includes a hand with fingers spread, a hand with fingers curled, and a hand with fingers spread.</p>
tortoise	<p>The SignWriting for 'tortoise' shows a hand with fingers spread, a hand with fingers curled, and a hand with fingers spread.</p>
tortoise	<p>The SignWriting for 'tortoise' includes a hand with fingers spread, a hand with fingers curled, and a hand with fingers spread.</p>







American Sign Language (ASL) Dictionary

Unedited 08082023

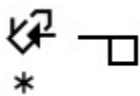
Spoken Word	SignWriting
tortoise	
toss and turn	
toss-and-turn	
toss-and-turn	
total-horizontal	
touch	
touch	*
touch	
touch-heart	
touch-heart-2	

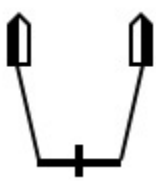



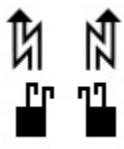
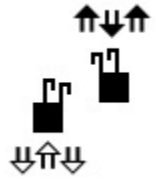

American Sign Language (ASL) Dictionary

Unedited 08082023

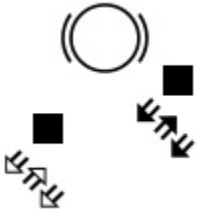
Spoken Word	SignWriting
touch-palm	
touch-you	
touchdown	
tough	
tough	
tournament	
tournament	
tournament	

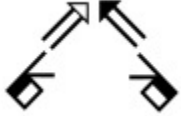
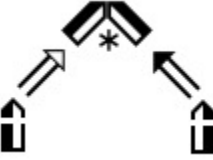
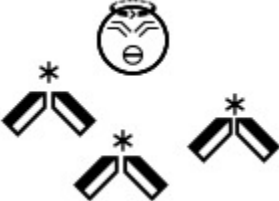

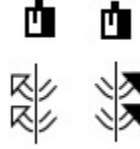
American Sign Language (ASL) Dictionary

Unedited 08082023

Spoken Word	SignWriting
towel	
towel	
tower	
tower	
town	
townhouse	
toy	
toy	



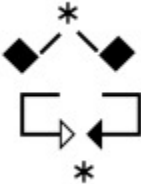
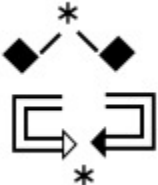
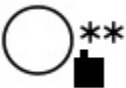

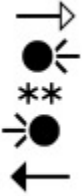
American Sign Language (ASL) Dictionary

Unedited 08082023

Spoken Word	SignWriting
trace - drawing	
trace-rectangle	
trace-rectangle	
Tracy	
tradition	
traffic	
Traffic	



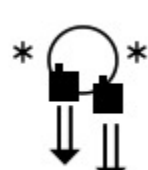
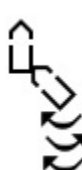
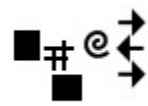
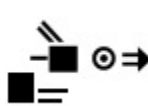
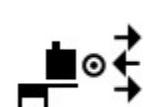



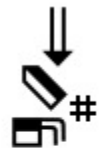

American Sign Language (ASL) Dictionary

Unedited 08082023

Spoken Word	SignWriting
traffic light	
traffic lights	
tragedy	
trailer	
train	
train gone	
training	
training	







American Sign Language (ASL) Dictionary

Unedited 08082023

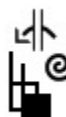
Spoken Word	SignWriting
trample-creature	 
transfer	
transfer	
transfer	
transform	 
Transgendered	
translate	

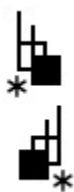
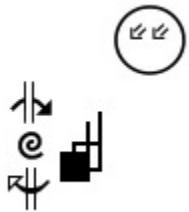

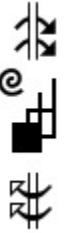

American Sign Language (ASL) Dictionary

Unedited 08082023

Spoken Word	SignWriting
translate	
translate	
translate	
translate	 
translate	
translate	
translated and written in American Sign Language	
translation	

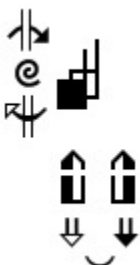
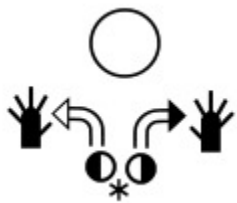
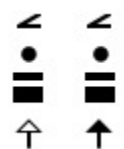





American Sign Language (ASL) Dictionary

Unedited 08082023

Spoken Word	SignWriting
translator	
transparency	
trap	
trap	
trash	
trash	
trash	



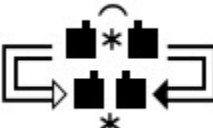

American Sign Language (ASL) Dictionary

Unedited 08082023

Spoken Word	SignWriting
travel	
travel	
travel	
travel-road	
traveler	
tray	
tray	
tread-on-snake	

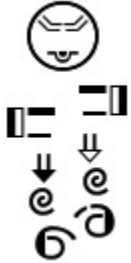
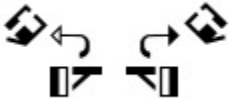

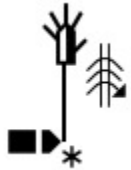

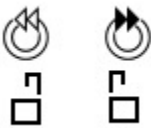

American Sign Language (ASL) Dictionary

Unedited 08082023

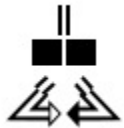
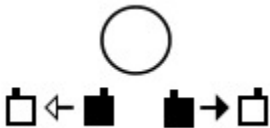
Spoken Word	SignWriting
treason	
treat all	
tree	
tree	
tree	
tree	
trespass	

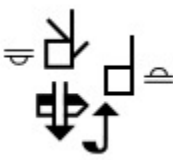

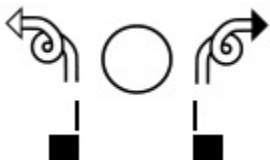



American Sign Language (ASL) Dictionary

Unedited 08082023

Spoken Word	SignWriting
Trey	
triangle	
tribe	
trigonometry	
Trinity	
trip	
triumph	
trivial	
trolley	



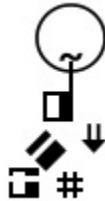

American Sign Language (ASL) Dictionary

Unedited 08082023

Spoken Word	SignWriting
trolley	
trophy	
trouble	
troubles	
truck	
truck	
truck	
true biz	

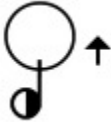
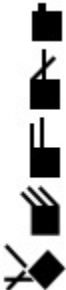

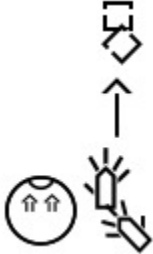

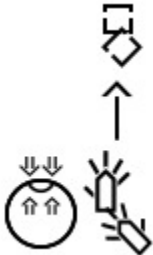

American Sign Language (ASL) Dictionary

Unedited 08082023

Spoken Word	SignWriting
truly	
Trump	
Trump	
trust	
trust	
trust (yes)	



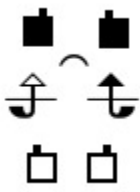

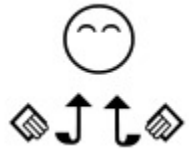

American Sign Language (ASL) Dictionary

Unedited 08082023

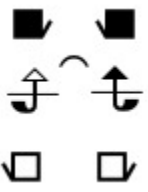
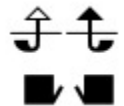
Spoken Word	SignWriting
truth	
truth	
truth	
truth	
try	
try	
try	

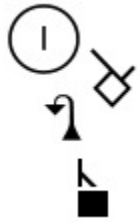



American Sign Language (ASL) Dictionary

Unedited 08082023

Spoken Word	SignWriting
try	
try	
TTY	
tucano	
Tucson	
Tucson	
Tuesday	
Tuesday	

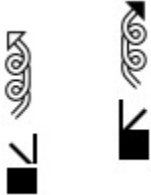
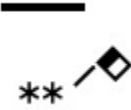
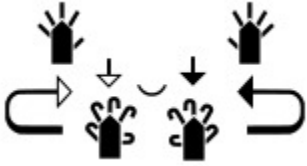
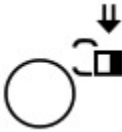
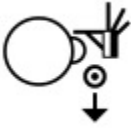





American Sign Language (ASL) Dictionary

Unedited 08082023

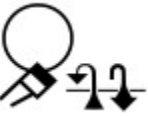
Spoken Word	SignWriting
tumble	
tummy	
tundra	
Tunisia	
Tunisia	
turantula	
Turkey	
Turkey	

American Sign Language (ASL) Dictionary

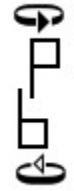
Unedited 08082023

Spoken Word	SignWriting
turkey	
turkey	
Turkish	
turn	
turn	
turn	
turn around	
turn around	









American Sign Language (ASL) Dictionary

Unedited 08082023

Spoken Word	SignWriting
turn for first	<p>The signwriting consists of a square with a horizontal line above it. A curved arrow starts from the top-right corner of the square and points upwards and to the right. Below the square is a square with a diagonal line from the top-left to the bottom-right. To the right of this square is another square with a horizontal line above it.</p>
turn for second	<p>The signwriting consists of a square with a diagonal line from the top-left to the bottom-right. To the right of this square is another square with a horizontal line above it. A curved arrow starts from the top-right corner of the second square and points upwards and to the right.</p>
turn left	<p>The signwriting consists of a square with a horizontal line above it. A curved arrow starts from the top-right corner of the square and points upwards and to the left.</p>
turn left close distance	<p>The signwriting consists of a circle containing two horizontal arrows pointing towards each other. Below the circle is a square with a horizontal line above it. To the left of this square is another square with a diagonal line from the top-left to the bottom-right. Below that is a square with a horizontal line above it. To the right of this square is another square with a horizontal line above it. A curved arrow starts from the top-right corner of the second square from the bottom and points upwards and to the left.</p>
turn left far distance	<p>The signwriting consists of a circle containing a square with a horizontal line above it. Below the circle is a square with a horizontal line above it. To the left of this square is another square with a horizontal line above it. Below that is a square with a horizontal line above it. To the right of this square is another square with a horizontal line above it. A curved arrow starts from the top-right corner of the second square from the bottom and points upwards and to the left.</p>
turn left medium distance	<p>The signwriting consists of a circle containing two horizontal arrows pointing towards each other. Below the circle is a square with a horizontal line above it. To the left of this square is another square with a horizontal line above it. Below that is a square with a horizontal line above it. To the right of this square is another square with a horizontal line above it. A curved arrow starts from the top-right corner of the second square from the bottom and points upwards and to the left.</p>









American Sign Language (ASL) Dictionary

Unedited 08082023

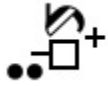
Spoken Word	SignWriting
turn off light	
turn off light	
turn off voice	
turn on light	
turn on light	
turn right	
turn-doorknob	
turtle	
turtle	

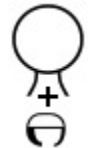

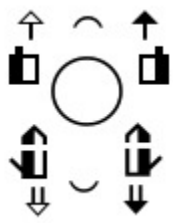

American Sign Language (ASL) Dictionary

Unedited 08082023

Spoken Word	SignWriting
turtle	
turtle	
turtle	
turtle	
turtle	
turtleneck sweater	
tusk	
tutor	
tv	
TV	

American Sign Language (ASL) Dictionary

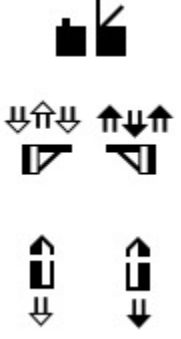
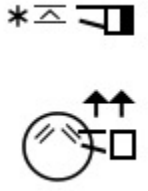
Unedited 08082023

Spoken Word	SignWriting
TV	
TV	
tv repairman	
tweezers	
twelve	
twelve	

American Sign Language (ASL) Dictionary

Unedited 08082023

Spoken Word	SignWriting
twelve o'clock	<p>The signwriting consists of a vertical line with a small circle at the top, followed by a square, an arrow pointing right, and a diamond shape with a small circle inside.</p>
twelve years old	<p>The signwriting consists of a circle, a square, an arrow pointing right, a diamond shape with a small circle inside, and another square.</p>
twelve years old	<p>The signwriting consists of a circle, a square, an arrow pointing right, a diamond shape with a small circle inside, and another square.</p>
twenty	<p>The signwriting consists of a square and a diamond shape with a small circle inside.</p>
twenty	<p>The signwriting consists of a square, a diamond shape with a small circle inside, and a small circle.</p>
twenty eight	<p>The signwriting consists of a square and a diamond shape with a small circle inside.</p>
twenty five cents	<p>The signwriting consists of a circle, a diamond shape with a small circle inside, an arrow pointing right, a small circle, and another diamond shape with a small circle inside.</p>
twenty five cents	<p>The signwriting consists of a circle, a diamond shape with a small circle inside, an arrow pointing right, a small circle, and another diamond shape with a small circle inside.</p>

American Sign Language (ASL) Dictionary

Unedited 08082023

Spoken Word	SignWriting
twenty five years old	
twenty five years old	
twenty four	
twenty four years old	
twenty nine	
twenty one years old	
twenty seven	
twenty six	
twenty three years old	







American Sign Language (ASL) Dictionary

Unedited 08082023

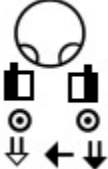
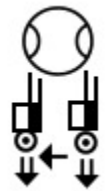
Spoken Word	SignWriting
twenty two years old	The signwriting consists of a circle with a vertical line extending downwards from its center, ending in a horizontal bar. To the right of this vertical line, there are two curved arrows pointing upwards and to the right, and a small square with a diagonal line through it.
twenty years old	The signwriting consists of a circle with a vertical line extending downwards from its center, ending in a horizontal bar. To the right of this vertical line, there is a curved arrow pointing upwards and to the right, and a small square with a diagonal line through it.
twenty years old	The signwriting consists of a circle with a vertical line extending downwards from its center, ending in a horizontal bar. To the right of this vertical line, there is a curved arrow pointing upwards and to the right, and a small square with a diagonal line through it.
twenty-two	The signwriting consists of two identical symbols side-by-side, connected by a horizontal arrow pointing from the first to the second. Each symbol is a square with a diagonal line from the top-left to the bottom-right, and a horizontal line extending from the bottom edge.
twice	The signwriting consists of a square with a diagonal line from the top-left to the bottom-right, and a horizontal line extending from the bottom edge. To the right of this square, there is a curved arrow pointing upwards and to the right, and a small square with a diagonal line through it.
twilight	The signwriting consists of two hands, one on the left and one on the right, with fingers spread. Between the hands, there are several small squares with diagonal lines, and a central asterisk.
twilight	The signwriting consists of two hands, one on the left and one on the right, with fingers spread. Between the hands, there are several small squares with diagonal lines, and a central asterisk.
twinkle	The signwriting consists of a horizontal arrow pointing to the right, above a wavy line. Below the wavy line, there is a small square with a diagonal line through it.

American Sign Language (ASL) Dictionary

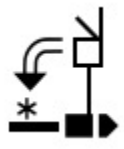
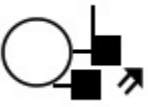
Unedited 08082023

Spoken Word	SignWriting
twins	
twins	
twins	
twins	
twist	
two days	
two days ago	
two days ago	









American Sign Language (ASL) Dictionary

Unedited 08082023

Spoken Word	SignWriting
two days ago	The signwriting symbol for 'two days ago' consists of a circle with a dot inside, a downward-pointing arrow, and a square with a diagonal line and a dot.
two dollars	The signwriting symbol for 'two dollars' consists of a downward-pointing arrow, a square with a diagonal line, and a solid black square.
two hours	The signwriting symbol for 'two hours' consists of a square with a diagonal line, a circle with a dot, and a downward-pointing arrow.
two hundred	The signwriting symbol for 'two hundred' consists of a square with a diagonal line, a downward-pointing arrow, and a solid black square.
two minutes	The signwriting symbol for 'two minutes' consists of a square with a diagonal line, a circle with a dot, and a downward-pointing arrow.
two months	The signwriting symbol for 'two months' consists of a square with a diagonal line, a downward-pointing arrow, and another square with a diagonal line.
two months	The signwriting symbol for 'two months' consists of a square with a diagonal line, a circle with a dot, and a downward-pointing arrow.
two months	The signwriting symbol for 'two months' consists of a square with a diagonal line, a circle with a dot, and a downward-pointing arrow.







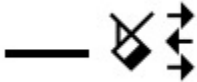

American Sign Language (ASL) Dictionary

Unedited 08082023

Spoken Word	SignWriting
two more	
two o'clock	
two o'clock	
two of them	
two of them	
two of us	
two of us	
two of us	
two of us	

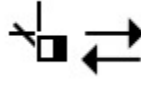
American Sign Language (ASL) Dictionary

Unedited 08082023

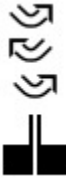
Spoken Word	SignWriting
two of us	
two of us	
two of us	
two of us (left hand)	
two of us (right hand)	
two of you	
two of you	
two of you	
two people meet (2)	
two people together	









American Sign Language (ASL) Dictionary

Unedited 08082023

Spoken Word	SignWriting
two weeks	
two weeks ago	
two weeks ago	
two weeks future	
two years ago	
two years ago	
two years ago	
two years ago	
two years old	



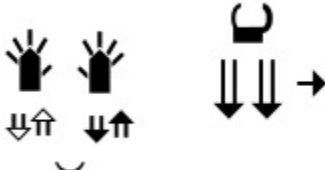



American Sign Language (ASL) Dictionary

Unedited 08082023

Spoken Word	SignWriting
two years old	
two-of-you	
two-of-you	
two-of-you	
type	
type	
type	
type-signs	

American Sign Language (ASL) Dictionary

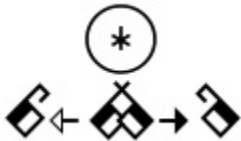
Unedited 08082023

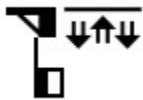
Spoken Word	SignWriting
type-words	
typing	
U	
U-receptive	
ugh	
ugly	
ugly	
ugly	
uh-huh	





American Sign Language (ASL) Dictionary

Unedited 08082023

Spoken Word	SignWriting
um	<p>The sign for 'um' is represented by a circle containing two small upward-pointing arrows above a horizontal line. Below this circle are two pairs of hand icons: the top pair shows hands with fingers spread, and the bottom pair shows hands with fingers together, palms facing each other.</p>
Umbanda	<p>The sign for 'Umbanda' is represented by a central circle with a horizontal line inside. To the left and right of this circle are two hand icons with fingers spread. Above the circle is a hand icon with fingers spread, and below it is a hand icon with fingers together, palms facing each other.</p>
umbrella	<p>The sign for 'umbrella' is represented by a hand icon with fingers spread, palm facing up, with two upward-pointing arrows above it.</p>
umbrella	<p>The sign for 'umbrella' is represented by a hand icon with fingers spread, palm facing up, with a small asterisk to its left and two upward-pointing arrows above it.</p>
ummm	<p>The sign for 'ummm' is represented by a diamond shape to the left of a hand icon with fingers spread, palm facing up. Below the hand icon is a hand icon with fingers together, palms facing each other.</p>
umpire	<p>The sign for 'umpire' is represented by a vertical sequence of hand icons: a hand with fingers spread, palm facing up; a hand with fingers spread, palm facing down; a hand with fingers spread, palm facing up; a hand with fingers spread, palm facing down; and a hand with fingers spread, palm facing up.</p>

American Sign Language (ASL) Dictionary

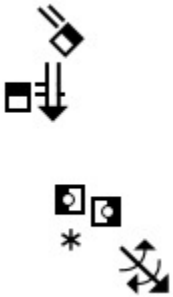
Unedited 08082023

Spoken Word	SignWriting
unaccustomed	
unaided	
unavoidable	
unaware	
unbalance	





American Sign Language (ASL) Dictionary

Unedited 08082023

Spoken Word	SignWriting
<p style="text-align: center;">unbeievable</p>	<p>The SignWriting for 'unbeievable' consists of three vertically stacked symbols. The top symbol is a circle with a square below it, an upward arrow, and a small circle with a dot. The middle symbol is a circle with a slash, a star, a square with a diagonal line, and a plus sign. The bottom symbol is a square with a diagonal line and a plus sign.</p>
<p style="text-align: center;">uncertain</p>	<p>The SignWriting for 'uncertain' consists of two vertically stacked symbols. The top symbol is a circle with a square below it, an upward arrow, and a small circle with a dot. The bottom symbol is a circle with a slash, a star, a square with a diagonal line, and an upward arrow.</p>
<p style="text-align: center;">uncle</p>	<p>The SignWriting for 'uncle' consists of a single symbol: a circle with a slash, a square with a diagonal line, and two downward arrows.</p>

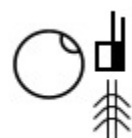
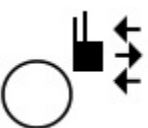
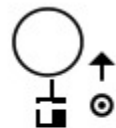
American Sign Language (ASL) Dictionary

Unedited 08082023

Spoken Word	SignWriting
uncle	
uncle	
uncle	
unclean	 
unconcerned	
unconscious	 







American Sign Language (ASL) Dictionary

Unedited 08082023

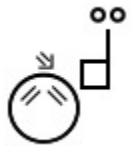
Spoken Word	SignWriting
unconstitutional	<p>The signwriting for 'unconstitutional' consists of two parts. The first part is a circle with a vertical line extending downwards from its center, ending in a small square, with an upward-pointing arrow to the left of the vertical line. The second part is a circle with a vertical line extending downwards from its center, ending in a small square, with an upward-pointing arrow to the right of the vertical line.</p>
undependable	<p>The signwriting for 'undependable' consists of two parts. The first part is a circle with a vertical line extending downwards from its center, ending in a small square, with an upward-pointing arrow to the right of the vertical line. The second part is a diamond shape with an 'X' inside, with a hand symbol below it showing fingers spread.</p>
under	<p>The signwriting for 'under' consists of a hand symbol with fingers spread, with an upward-pointing arrow to the left of the hand, and a small square below the hand.</p>
underclothes	<p>The signwriting for 'underclothes' consists of two parts. The first part is a hand symbol with fingers spread, with an upward-pointing arrow to the left of the hand, and a small square below the hand. The second part is a hand symbol with fingers spread, with an upward-pointing arrow to the left of the hand, and a small square below the hand.</p>
underpants	<p>The signwriting for 'underpants' consists of a horizontal line with a vertical line extending downwards from its center, ending in a small square. There are upward-pointing arrows on both sides of the horizontal line, and hand symbols with fingers spread below the horizontal line.</p>
understand	<p>The signwriting for 'understand' consists of a circle with a vertical line extending downwards from its center, ending in a small square, with an upward-pointing arrow to the left of the vertical line.</p>

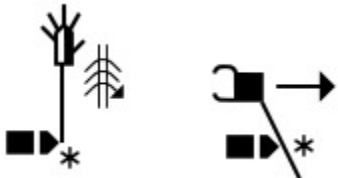



American Sign Language (ASL) Dictionary

Unedited 08082023

Spoken Word	SignWriting
understand	
understand that	
understand?	
understory	
underwear	
underwear	
underwear	

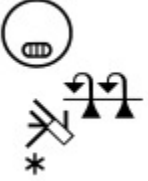

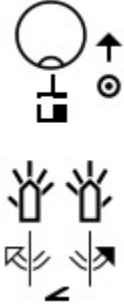
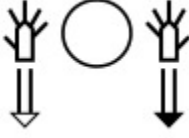
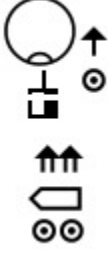





American Sign Language (ASL) Dictionary

Unedited 08082023

Spoken Word	SignWriting
uneasy	
unemployed	
unfinished	
unfortunately	
unhappy	
Unicorn	

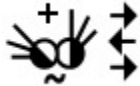





American Sign Language (ASL) Dictionary

Unedited 08082023

Spoken Word	SignWriting
unicorn	
UNIFAL-MG	
unite	
unite	
united	
United States	
unity	
Unity	
universe	



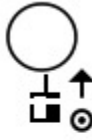



American Sign Language (ASL) Dictionary

Unedited 08082023

Spoken Word	SignWriting
Universita`	
university	
university	
university	
unknown	
unreliable	 
unseen	
unsettled	



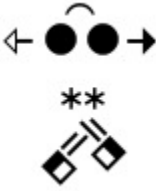



American Sign Language (ASL) Dictionary

Unedited 08082023

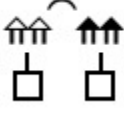
Spoken Word	SignWriting
unshaven	
unskilled	
unskilled	
until	
until	
untitled	
unusual	
unwanted	





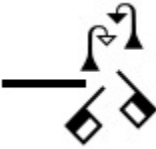
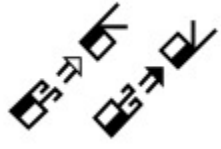

American Sign Language (ASL) Dictionary

Unedited 08082023

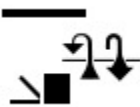
Spoken Word	SignWriting
up	
up	
up	
up and downs	
up left hand	
up there	
up-right hand	
up-until-now	
upload	

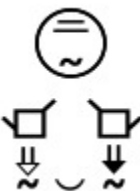

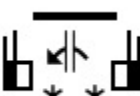
American Sign Language (ASL) Dictionary

Unedited 08082023

Spoken Word	SignWriting
upset	
uranus	
urgent	
us	
us - left hand	
us - right hand	
USA	
USA	

American Sign Language (ASL) Dictionary

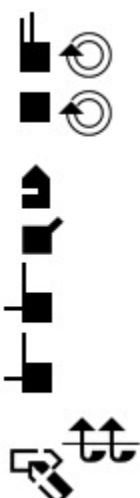
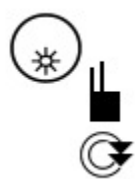
Unedited 08082023

Spoken Word	SignWriting
USBillofRights	 <p>The SignWriting for 'USBillofRights' consists of a vertical sequence of symbols: a hand with index and middle fingers extended, a square, a hand with index and middle fingers extended, a square, a hand with index and middle fingers extended, a square, a hand with index and middle fingers extended, a square, a hand with index and middle fingers extended, a square, and finally a hand with index and middle fingers extended next to two vertical arrows pointing up and down.</p>
USBillofRights	 <p>The SignWriting for 'USBillofRights' is identical to the first row, showing a vertical sequence of symbols: a hand with index and middle fingers extended, a square, a hand with index and middle fingers extended, a square, a hand with index and middle fingers extended, a square, a hand with index and middle fingers extended, a square, a hand with index and middle fingers extended, a square, and finally a hand with index and middle fingers extended next to two vertical arrows pointing up and down.</p>
use	 <p>The SignWriting for 'use' consists of a circle containing a starburst symbol, a hand with index and middle fingers extended, and a square with a circular arrow around it.</p>
use	 <p>The SignWriting for 'use' consists of a circle containing a starburst symbol, a hand with index and middle fingers extended, a square, and a circular arrow around it.</p>

American Sign Language (ASL) Dictionary

Unedited 08082023

Spoken Word	SignWriting
use	
use	
use	
use	
use	
use credit card	
use up	
Useful Verbs	
Useful Verbs	







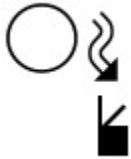

American Sign Language (ASL) Dictionary

Unedited 08082023

Spoken Word	SignWriting
Useful Verbs	<p>The signwriting consists of a circle with a downward-pointing arrow inside, positioned above two separate hand configurations. Each configuration shows a hand with a square marker and arrows indicating movement directions.</p>
Utah	<p>The signwriting consists of a series of four hand configurations: a hand with a square marker and an upward arrow, a hand with a square marker and a downward arrow, a hand with a square marker and a rightward arrow, and a hand with a square marker and a leftward arrow.</p>
Utah	<p>The signwriting consists of a large circle on the left and a hand configuration on the right with a square marker and a wavy arrow pointing upwards.</p>
Utah	<p>The signwriting consists of a large circle on the left and a hand configuration on the right with a square marker and a wavy arrow pointing downwards.</p>
Utah	<p>The signwriting consists of a large circle on the left and a hand configuration on the right with a square marker and a wavy arrow pointing downwards.</p>
utilize	<p>The signwriting consists of a hand configuration with a square marker and a circular arrow, positioned above another hand configuration with a square marker and a diagonal arrow pointing downwards.</p>
ututututut	<p>The signwriting consists of a large circle on the left and a hand configuration on the right with a square marker and two downward-pointing arrows.</p>
V	<p>The signwriting consists of a hand configuration with a square marker and a downward-pointing arrow.</p>
v neck	<p>The signwriting consists of a horizontal line above a hand configuration with a square marker and a downward-pointing arrow.</p>

American Sign Language (ASL) Dictionary

Unedited 08082023

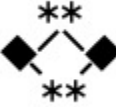
Spoken Word	SignWriting
V sign name	
V-Receptive	
vacant	
vacant	
vacation	
vacation	
vacuum	
vacuum	
vagina	

American Sign Language (ASL) Dictionary

Unedited 08082023

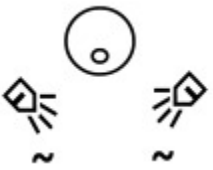
Spoken Word	SignWriting
vague	 The SignWriting for 'vague' consists of a hand with fingers spread, a small circle with a dot inside, and a larger circle with a dot inside.
vain	 The SignWriting for 'vain' consists of two hands with fingers spread, a circle with a dot inside, and two small squiggly lines below each hand.









American Sign Language (ASL) Dictionary

Unedited 08082023

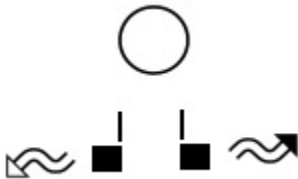
Spoken Word	SignWriting
Val	<p>The SignWriting for 'Val' consists of three symbols: a circle with a smiling face, a hand with fingers spread, and a downward-pointing arrow.</p>
Valerie	<p>The SignWriting for 'Valerie' is a vertical sequence of seven symbols: a hand with fingers spread, a hand with fingers spread, a hand with fingers spread, a hand with fingers spread, a hand with fingers spread, a hand with fingers spread, and a hand with fingers spread.</p>
Valerie	<p>The SignWriting for 'Valerie' consists of three symbols: a circle with a smiling face, a hand with fingers spread, and a downward-pointing arrow.</p>
Valerie Sutton	<p>The SignWriting for 'Valerie Sutton' consists of two symbols: a hand with fingers spread and a downward-pointing arrow.</p>
valley	<p>The SignWriting for 'valley' consists of two symbols: a hand with fingers spread and a downward-pointing arrow.</p>
vampire	<p>The SignWriting for 'vampire' consists of three symbols: a circle with a smiling face, a hand with fingers spread, and a downward-pointing arrow.</p>





American Sign Language (ASL) Dictionary

Unedited 08082023

Spoken Word	SignWriting
vanilla	
vanilla	
variable	
various	
various	
various	
various	
vegetable	



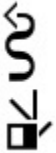
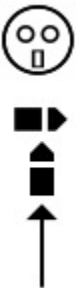



American Sign Language (ASL) Dictionary

Unedited 08082023

Spoken Word	SignWriting
vegetable	
vegetable	
vehicle	
vehicle driving forward on curved road	
vehicle goes over cliff screaming	
venison	



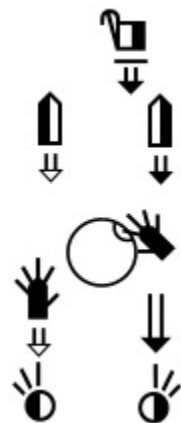





American Sign Language (ASL) Dictionary

Unedited 08082023

Spoken Word	SignWriting
venus	
Vera Thomas	
verb	
verb	
verbal fight	
verdict	
Vermont	

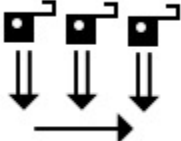



American Sign Language (ASL) Dictionary

Unedited 08082023

Spoken Word	SignWriting
Vermont	
Vermont	
verse	
verse	
verse	
vertical columns	
vertically striped shirt	
very	
very distant future	

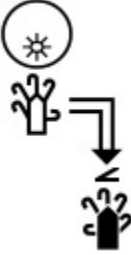
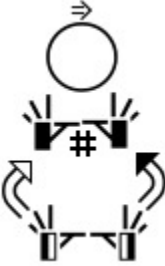

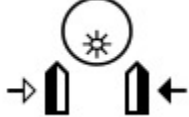



American Sign Language (ASL) Dictionary

Unedited 08082023

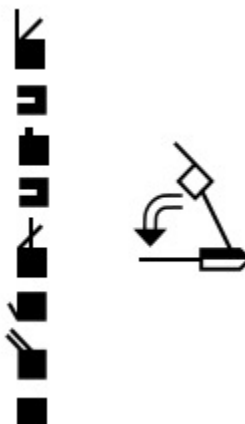
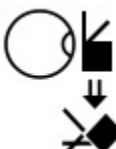
Spoken Word	SignWriting
very hot	
very important	
very recently	
very short hair	
very small	
Vessel	







American Sign Language (ASL) Dictionary

Unedited 08082023

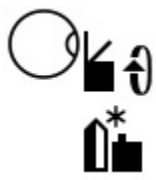
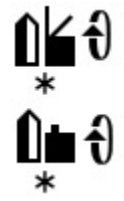
Spoken Word	SignWriting
Veteran's Day	
vice president	
video	
video games	
video phone	
videophone	
videophone	



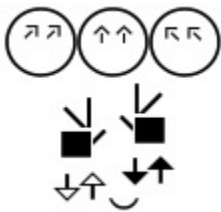



American Sign Language (ASL) Dictionary

Unedited 08082023

Spoken Word	SignWriting
videotape	
videotape	
Vietnam	
Vietnam	
Vietnamese	
view	
vigilant	
village	

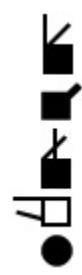
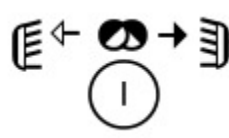





American Sign Language (ASL) Dictionary

Unedited 08082023

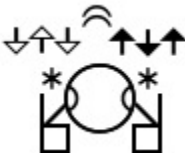
Spoken Word	SignWriting
virgin	
Virginia	
Virginia	
Virgo	
vision	
visit	
visit (v)	
visit (v) I visit you	

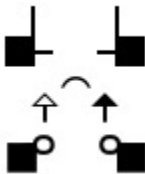
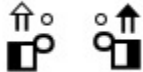
American Sign Language (ASL) Dictionary

Unedited 08082023

Spoken Word	SignWriting
visit (v) you visit me	
visual	
visualize	
Vlog	
vlog	
VOCABULARY	
vocabulary	
vocabulary	
vocabulary	



American Sign Language (ASL) Dictionary

Unedited 08082023

Spoken Word	SignWriting
vocabulary	<p>The symbol consists of two vertical arrows pointing towards each other, with two asterisks above them. Below this is a square containing a triangle, and another square to its right.</p>
vocabulary	<p>The symbol features two asterisks above a square containing a triangle, with another square to its right.</p>
vocabulary list	<p>The symbol includes two asterisks above a square containing a triangle, another square to its right, a square containing a triangle with a vertical line through it, and a double-headed vertical arrow below.</p>
voice	<p>The symbol shows a circle above a square containing a triangle, with a vertical arrow pointing up and a small circle to the right.</p>
voice	<p>The symbol shows a circle above a square containing a triangle, with a vertical arrow pointing up and a small circle to the right.</p>
voices in the head	<p>The symbol features two circles with wavy lines inside, one above the other. Between them is a vertical line with a hook. Four triangles are positioned around the circles, with arrows pointing towards the center.</p>



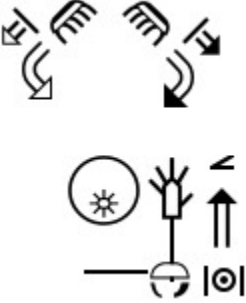
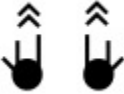
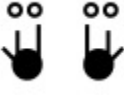
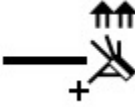
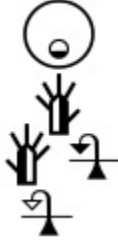







American Sign Language (ASL) Dictionary

Unedited 08082023

Spoken Word	SignWriting
void	
volcano	
volleyball	
volleyball	
volunteer	
vomit	
vomit	

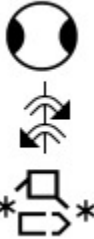

American Sign Language (ASL) Dictionary

Unedited 08082023

Spoken Word	SignWriting
vote	
vote	
vote	
VOW	
VRS	
W	
W	
W-receptive	
waddle	
wager	

American Sign Language (ASL) Dictionary

Unedited 08082023

Spoken Word	SignWriting
wait	
wait	
wait	







American Sign Language (ASL) Dictionary

Unedited 08082023

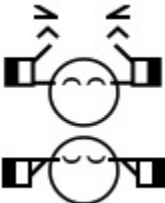
Spoken Word	SignWriting
wait long time	<p>The SignWriting symbol consists of two vertical hand signs at the top, each with a wavy line above it. Below these are two circular face signs, each with a vertical line through the center and a small triangle at the bottom.</p>
wait over time	<p>The SignWriting symbol consists of two vertical hand signs at the top, each with a wavy line above it. Below these are two circular face signs, each with a vertical line through the center and a small triangle at the bottom.</p>
waiter	<p>The SignWriting symbol shows a hand sign with a wavy line above it, followed by a circular face sign with a vertical line through the center and a small triangle at the bottom. To the right, there is another hand sign with a wavy line above it and a small triangle at the bottom.</p>
waiter	<p>The SignWriting symbol shows a hand sign with a wavy line above it, followed by a circular face sign with a vertical line through the center and a small triangle at the bottom. To the right, there is another hand sign with a wavy line above it and a small triangle at the bottom.</p>
waive	<p>The SignWriting symbol shows a hand sign with a wavy line above it, followed by a circular face sign with a vertical line through the center and a small triangle at the bottom. To the right, there is another hand sign with a wavy line above it and a small triangle at the bottom.</p>
wake up	<p>The SignWriting symbol shows a hand sign with a wavy line above it, followed by a circular face sign with a vertical line through the center and a small triangle at the bottom. To the right, there is another hand sign with a wavy line above it and a small triangle at the bottom.</p>
wake up	<p>The SignWriting symbol shows a hand sign with a wavy line above it, followed by a circular face sign with a vertical line through the center and a small triangle at the bottom. To the right, there is another hand sign with a wavy line above it and a small triangle at the bottom.</p>

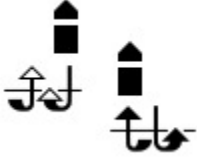

American Sign Language (ASL) Dictionary

Unedited 08082023

Spoken Word	SignWriting
wake up	
wake up	
Wales	
walk	
walk	
walk	
walk	



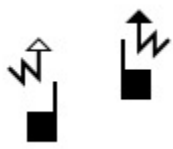
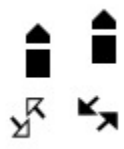
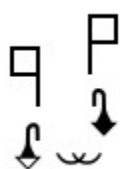
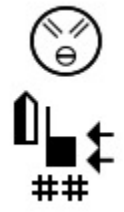

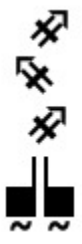
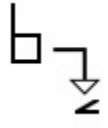

American Sign Language (ASL) Dictionary

Unedited 08082023

Spoken Word	SignWriting
walk	
walk	
walk backwards	
walk into a wall twice	
walk like a drunk forward	
walk up a hill together	
walk up to me	



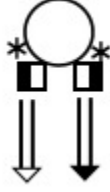

American Sign Language (ASL) Dictionary

Unedited 08082023

Spoken Word	SignWriting
wall	
wall	
wall around	
wallet	
wallet	
walrus	
wander	
Wander	



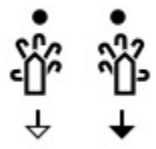
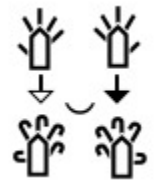

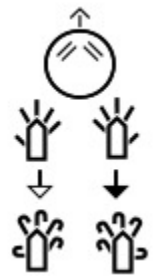

American Sign Language (ASL) Dictionary

Unedited 08082023

Spoken Word	SignWriting
wander	
wander left	
want	
want	
want	
want? yes-no question	
want? yes-no question	

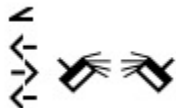







American Sign Language (ASL) Dictionary

Unedited 08082023

Spoken Word	SignWriting
war	
war	
war	
war	
war	
warm	
warm	
warm	

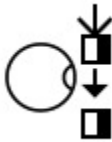



American Sign Language (ASL) Dictionary

Unedited 08082023

Spoken Word	SignWriting
warm	
warm	
warm	
warn	
was	
wash	
wash	
wash	
wash	

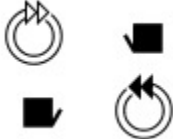
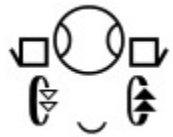

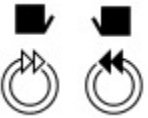
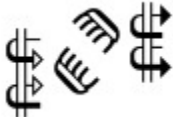
American Sign Language (ASL) Dictionary

Unedited 08082023

Spoken Word	SignWriting
wash car or object	
wash face	
wash hair	
wash hair	
wash-car	
washer	
washing machine	
washing machine	



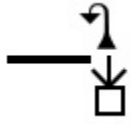
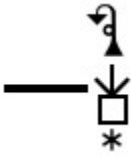
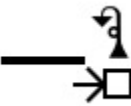
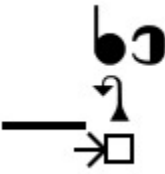

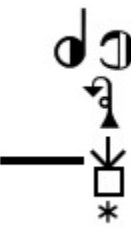

American Sign Language (ASL) Dictionary

Unedited 08082023

Spoken Word	SignWriting
Washington	
Washington	
Washington	
Washington DC	
Washington DC	
Washington DC	
Washinton DC	



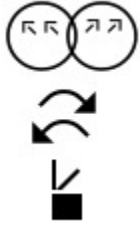
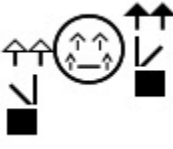



American Sign Language (ASL) Dictionary

Unedited 08082023

Spoken Word	SignWriting
waste	
wastebasket	
watch	
watch	
watch	
watch	
watch	
watch	

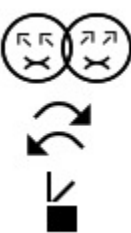
American Sign Language (ASL) Dictionary

Unedited 08082023

Spoken Word	SignWriting
watch	
watch	
watch	
watch	
water	
water	
water	
water	





American Sign Language (ASL) Dictionary

Unedited 08082023

Spoken Word	SignWriting
water flow	<p>The signwriting consists of two parts. The first part shows a circle above a square with a downward arrow and two asterisks (**). The second part shows a hand with fingers spread, a square, and a downward arrow with a horizontal line below it.</p>
water moving	<p>The signwriting consists of two parts. The first part shows two vertical arrows (one up, one down) above a wavy line, with a hand below. The second part shows two vertical arrows (one up, one down) above a wavy line, with a hand below.</p>
water moving faster	<p>The signwriting consists of two parts. The first part shows a hand with fingers spread, a square, and a downward arrow with a horizontal line below it. The second part shows a hand with fingers spread, a square, and a downward arrow with a horizontal line below it.</p>
water polo	<p>The signwriting consists of two parts. The first part shows a circle above a square with a downward arrow and two asterisks (**). The second part shows a hand with fingers spread, a square, and a downward arrow with a horizontal line below it.</p>
water polo	<p>The signwriting consists of two parts. The first part shows a circle above a square with a downward arrow. The second part shows two upward arrows above a hand with fingers spread.</p>



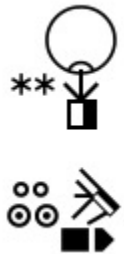
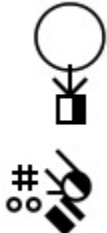



American Sign Language (ASL) Dictionary

Unedited 08082023

Spoken Word	SignWriting
water surrounds	
water-deepens	
watermelon	
watermelon	
watershed	





American Sign Language (ASL) Dictionary

Unedited 08082023

Spoken Word	SignWriting
wave	
wave	
wave	
wave	
waves	
waves	

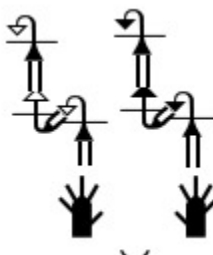

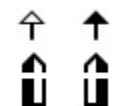

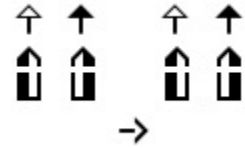

American Sign Language (ASL) Dictionary

Unedited 08082023

Spoken Word	SignWriting
waves big	
waves big	
waves big	
way	
way left	
way right	
ways	
We	

American Sign Language (ASL) Dictionary

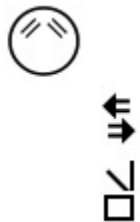
Unedited 08082023

Spoken Word	SignWriting
We	
we	
we	
we	
we - left hand	
We two	
We two	
weak	
weak-mind	









American Sign Language (ASL) Dictionary

Unedited 08082023

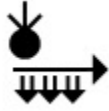
Spoken Word	SignWriting
wealthy	
wealthy	
wean	
wear	
weary	
weather	
weather	
weather	









American Sign Language (ASL) Dictionary

Unedited 08082023

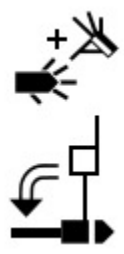
Spoken Word	SignWriting
weatherman	
weave	
web	
web page	
Wedding	
wedding	
wedding	
wedding	





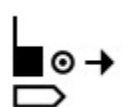

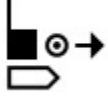
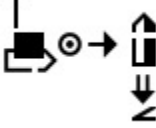
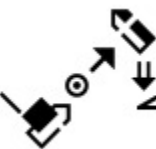

American Sign Language (ASL) Dictionary

Unedited 08082023

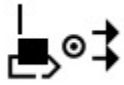
Spoken Word	SignWriting
wedding	
wedding	
wedding day	
Wednesday	
Wednesday	
week	
week	
week	
week	









American Sign Language (ASL) Dictionary

Unedited 08082023

Spoken Word	SignWriting
Week	
weekend	
weekend	
weekly	
weekly	
weight	
weight	
weight lifting	
weightlifting	
weird	

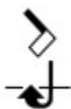







American Sign Language (ASL) Dictionary

Unedited 08082023

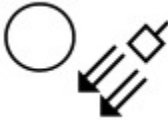
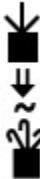
Spoken Word	SignWriting
weird	
welcome	
welcome	
welcome	
welcome	
welcome	
welcome	
welcome	
welcome (person left)	



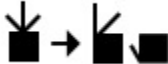

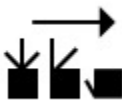
American Sign Language (ASL) Dictionary

Unedited 08082023

Spoken Word	SignWriting
welcome (person right)	
weld	
welfare	
Welsh	
were	
west	
west	
West Virginia	
West Virginia	
West-Virginia	

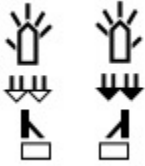
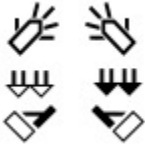

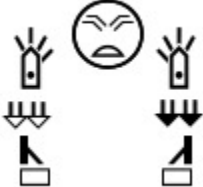
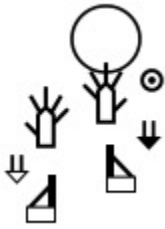
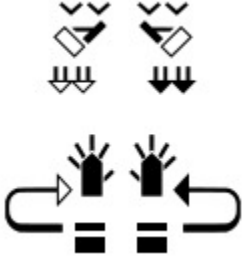

American Sign Language (ASL) Dictionary

Unedited 08082023

Spoken Word	SignWriting
wet	
wet	
wet	
wet	
wet	
wetland	
WH ? NMS	

American Sign Language (ASL) Dictionary

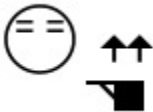
Unedited 08082023

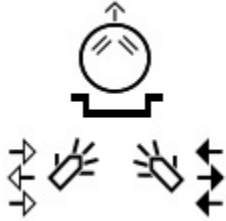
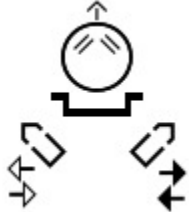
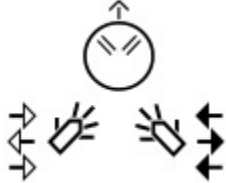
Spoken Word	SignWriting
Wh facial expression	
whale	
whale	
What	
what	
what	
what	
what	

American Sign Language (ASL) Dictionary

Unedited 08082023

Spoken Word	SignWriting
what	
what	
what	
what	
what	
what	
what	

American Sign Language (ASL) Dictionary

Unedited 08082023

Spoken Word	SignWriting
what	<p>The signwriting for 'what' consists of three parts: a circle with an upward arrow and a '0' below it, two hand icons with arrows pointing left and right, and another two hand icons with arrows pointing left and right.</p>
what - left hand	<p>The signwriting for 'what - left hand' consists of a square, a hand icon with an upward arrow, and a hand icon with a downward arrow.</p>
What for?	<p>The signwriting for 'What for?' consists of two circles with horizontal lines, a hand icon with a downward arrow, and a hand icon with a downward arrow.</p>
What is your name?	
What is your name?	
what kind?	<p>The signwriting for 'what kind?' consists of a circle with horizontal lines, a hand icon with a downward arrow, a hand icon with a downward arrow, and a hand icon with a downward arrow.</p>
What year?	<p>The signwriting for 'What year?' consists of a circle with horizontal lines, a hand icon with a downward arrow, a hand icon with a downward arrow, and a hand icon with a downward arrow.</p>

American Sign Language (ASL) Dictionary

Unedited 08082023

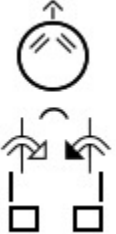
Spoken Word	SignWriting
what's happening?	 <p>The SignWriting symbol for 'what's happening?' consists of three parts: a top circle with an upward-pointing arrow and two diagonal lines inside; a middle curved line with two upward-pointing arrows; and a bottom structure of two vertical lines, each ending in a square, with a small square between them.</p>





American Sign Language (ASL) Dictionary

Unedited 08082023

Spoken Word	SignWriting
what's happening?	<p>The SignWriting symbol for 'what's happening?' consists of a circle with an upward-pointing arrow above it. Below the circle are two curved arrows pointing outwards, a central dot, and two crossed hands with arrows pointing towards each other. At the bottom are two asterisks.</p>
what's the matter	<p>The SignWriting symbol for 'what's the matter' features a circle with a downward-pointing arrow below it. Below the circle is a square with a downward-pointing arrow, and at the bottom are two downward-pointing arrows.</p>
what's up	<p>The SignWriting symbol for 'what's up' shows two crossed hands with arrows pointing upwards and outwards. Below the hands are two small circles and a curved line.</p>
what's wrong?	<p>The SignWriting symbol for 'what's wrong?' is a circle with an upward-pointing arrow above it. Below the circle is a square with a downward-pointing arrow.</p>
What's wrong?	<p>The SignWriting symbol for 'What's wrong?' is a circle with a downward-pointing arrow below it. Below the circle is a square with a downward-pointing arrow and two asterisks.</p>
what's-up	<p>The SignWriting symbol for 'what's-up' is a circle with a downward-pointing arrow below it. Below the circle are two crossed hands with arrows pointing towards each other, and at the bottom is an asterisk.</p>

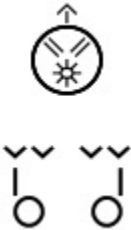
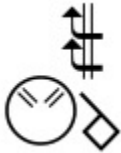

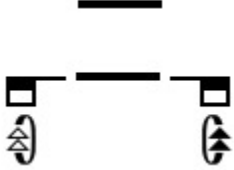
American Sign Language (ASL) Dictionary

Unedited 08082023

Spoken Word	SignWriting
what-do?	
what-for	
Wheel	
wheel	
wheelchair	
When	
When	
When	
When	
when	

American Sign Language (ASL) Dictionary

Unedited 08082023

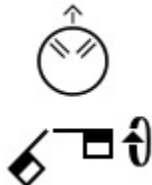
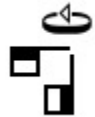
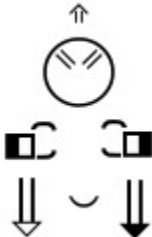
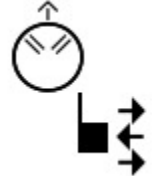
Spoken Word	SignWriting
when	
when	
when	
when	
when	
when - left hand primary	
Where	
where	

American Sign Language (ASL) Dictionary

Unedited 08082023

Spoken Word	SignWriting
where	
where	
where - left hand	
Where is my dictionary?	
whew	
which	
which	
which	







American Sign Language (ASL) Dictionary

Unedited 08082023

Spoken Word	SignWriting
which	<p>The SignWriting for 'which' consists of a circle with an upward arrow above it, containing two diagonal lines. Below this are two square boxes, each with a downward arrow above it. Underneath the boxes are two sets of arrows: the left set has a downward arrow followed by an upward arrow, and the right set has an upward arrow followed by a downward arrow.</p>
Which	<p>The SignWriting for 'Which' consists of two square boxes, each with a downward arrow above it. Below the boxes are two sets of arrows: the left set has a downward arrow followed by an upward arrow, and the right set has a downward arrow followed by an upward arrow, with a small curved line between the two sets.</p>
whipping	<p>The SignWriting for 'whipping' consists of a square box with a diagonal line through it, a square box with two diagonal lines, and two upward arrows below.</p>
whiskey	<p>The SignWriting for 'whiskey' consists of a circle with a diagonal line through it, a square box with a diagonal line, and a hand with fingers spread below.</p>
whiskey	<p>The SignWriting for 'whiskey' consists of a square box with a diagonal line, two asterisks, and a hand with fingers spread below.</p>
whiskey	<p>The SignWriting for 'whiskey' consists of two asterisks, a square box with a diagonal line, and a vertical bar below.</p>
whisper	<p>The SignWriting for 'whisper' consists of a circle with an upward arrow above it, containing a star, and a hand with fingers spread below.</p>
whispering	<p>The SignWriting for 'whispering' consists of a circle with a star inside, followed by two wavy lines, a hand with fingers spread, and another set of wavy lines below.</p>

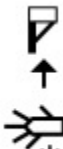
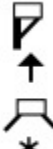

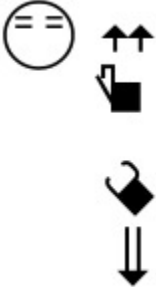





American Sign Language (ASL) Dictionary

Unedited 08082023

Spoken Word	SignWriting
whistle	
white	
white	
white	
white	
white	
Who	
who	

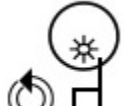
American Sign Language (ASL) Dictionary

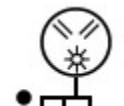
Unedited 08082023

Spoken Word	SignWriting
who	
who	
who	
who	
who	
who	
who	
who	









American Sign Language (ASL) Dictionary

Unedited 08082023

Spoken Word	SignWriting
who	
who	
who - left hand	
Who's there?	
Who's there?	
whoever	
whom	
whore	
Why	

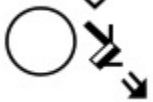





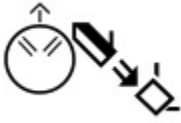

American Sign Language (ASL) Dictionary

Unedited 08082023

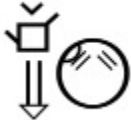
Spoken Word	SignWriting
why	
why	
why	
why	
why	
why	
why	
why	
why	
why	



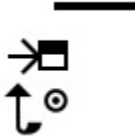



American Sign Language (ASL) Dictionary

Unedited 08082023

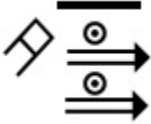
Spoken Word	SignWriting
why	
why	
why - left hand	
why - right hand	
why-not	
why-not	
why-not	
Wicca	
wicked	

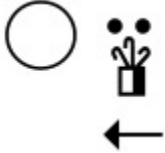
American Sign Language (ASL) Dictionary

Unedited 08082023

Spoken Word	SignWriting
wide	
wide horizontally striped shirt	
widow	
WIERD	
wife	
wife	
wife	

American Sign Language (ASL) Dictionary

Unedited 08082023

Spoken Word	SignWriting
wife	<p>The SignWriting for 'wife' consists of a large circle at the top, followed by a smaller circle with a plus sign inside, and a hand symbol with an arrow pointing to the right.</p>
Wife	<p>The SignWriting for 'Wife' consists of a large circle at the top, followed by a smaller circle with an asterisk inside, and a hand symbol with an arrow pointing to the right.</p>
wiggle nose	<p>The SignWriting for 'wiggle nose' consists of a large circle at the top, followed by a smaller circle with a horizontal line through it, and a hand symbol with an arrow pointing to the right.</p>
Wikipedia	<p>The SignWriting for 'Wikipedia' consists of a large circle at the top, followed by a smaller circle with a horizontal line through it, and a hand symbol with an arrow pointing to the right.</p>
wild	<p>The SignWriting for 'wild' consists of a large circle at the top, followed by a smaller circle with a horizontal line through it, and a hand symbol with an arrow pointing to the right.</p>
Will	
will	<p>The SignWriting for 'will' consists of a large circle at the top, followed by a smaller circle with a horizontal line through it, and a hand symbol with an arrow pointing to the right.</p>
will	<p>The SignWriting for 'will' consists of a large circle at the top, followed by a smaller circle with a horizontal line through it, and a hand symbol with an arrow pointing to the right.</p>







American Sign Language (ASL) Dictionary

Unedited 08082023

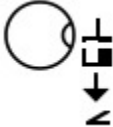
Spoken Word	SignWriting
will	

American Sign Language (ASL) Dictionary

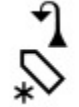
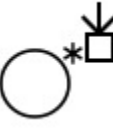
Unedited 08082023

Spoken Word	SignWriting
will not	
William Willard	
William Willard	
willing	
willing	
Willy	
win	
win	







American Sign Language (ASL) Dictionary

Unedited 08082023

Spoken Word	SignWriting
win	<p>The SignWriting for 'win' consists of a square symbol with a small square inside, a curved arrow pointing up and to the right, and a hand symbol with fingers spread.</p>
wind	<p>The SignWriting for 'wind' includes a circle with a starburst inside, two hand symbols with fingers spread, and two curved arrows pointing in opposite directions.</p>
wind	<p>The SignWriting for 'wind' includes a circle with a starburst inside, two hand symbols with fingers spread, and two curved arrows pointing in opposite directions.</p>
wind	<p>The SignWriting for 'wind' includes a circle with a starburst inside, two hand symbols with fingers spread, and two curved arrows pointing in opposite directions.</p>
wind up	<p>The SignWriting for 'wind up' features a square symbol with a starburst inside, a hand symbol with fingers spread, and a large arrow pointing up and to the right.</p>
wind-up	<p>The SignWriting for 'wind-up' shows a hand symbol with fingers spread, a square symbol with a starburst inside, and two curved arrows pointing in opposite directions.</p>
winding path	<p>The SignWriting for 'winding path' consists of a hand symbol with fingers spread and a wavy arrow pointing upwards.</p>



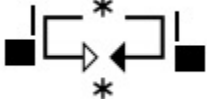

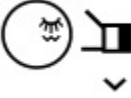
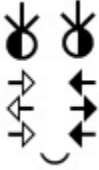
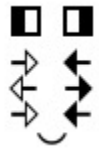



American Sign Language (ASL) Dictionary

Unedited 08082023

Spoken Word	SignWriting
window	
window	
window	
window	
Window CL	
wine	
wink	
winter	
winter	



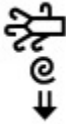
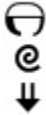



American Sign Language (ASL) Dictionary

Unedited 08082023

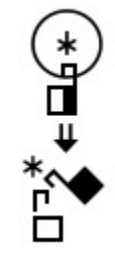
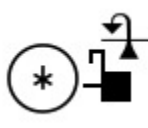
Spoken Word	SignWriting
Wisconsin	
Wisconsin	
wisdom	
wisdom	
wisdom	
wise	
wise	
wish	
wish	
witch	

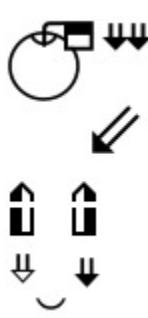



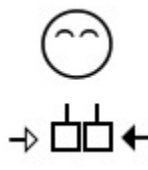

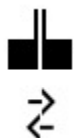

American Sign Language (ASL) Dictionary

Unedited 08082023

Spoken Word	SignWriting
witch	
witch	
witch	
Witch	
with	
with	
with	
with	



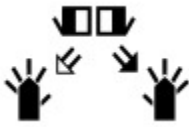



American Sign Language (ASL) Dictionary

Unedited 08082023

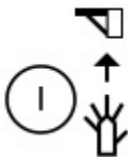
Spoken Word	SignWriting
with someone	
withdraw	
withdraw money ATM	
within	
within	
within	
without	
witness	
wizard	





American Sign Language (ASL) Dictionary

Unedited 08082023

Spoken Word	SignWriting
wobble	
wolf	
wolf	
wolf	
woman	
woman	
woman	



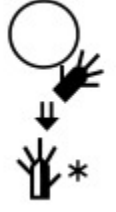

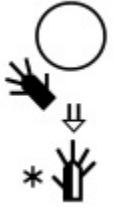

American Sign Language (ASL) Dictionary

Unedited 08082023

Spoken Word	SignWriting
woman	
woman	
woman	
woman	
woman	
woman-left	

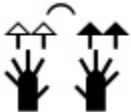

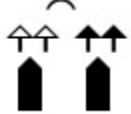
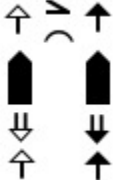





American Sign Language (ASL) Dictionary

Unedited 08082023

Spoken Word	SignWriting
wonder	
wonder	
wonder	
wonderful	
wonderful	
wonderful	
wonderful	
wonderful	
wonderful	









American Sign Language (ASL) Dictionary

Unedited 08082023

Spoken Word	SignWriting
wood	
wood	
wool	
word	
Word of God	
words	
words again	
work	
work	
work	
work	



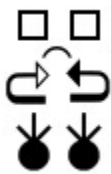

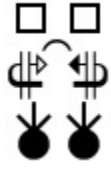

American Sign Language (ASL) Dictionary

Unedited 08082023

Spoken Word	SignWriting
work	
work	
work hard	
work out	
workaholic	
worker	
workshop	
workshop	
workshop	



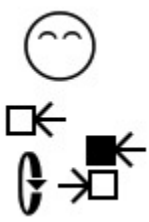

American Sign Language (ASL) Dictionary

Unedited 08082023

Spoken Word	SignWriting
world	
world	
world	
world	
world	
world	
worm	

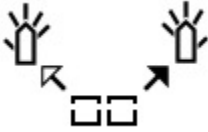
American Sign Language (ASL) Dictionary

Unedited 08082023

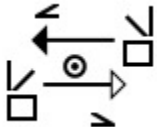
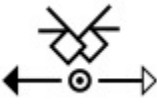
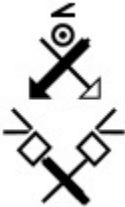
Spoken Word	SignWriting
worn out	
worn-out	
worry	
worry	
worse	
worse	
worse	







American Sign Language (ASL) Dictionary

Unedited 08082023

Spoken Word	SignWriting
worse	The SignWriting symbol for 'worse' consists of two square boxes at the top, one on the left and one on the right. Below them is a central circle with a dot in the middle. At the bottom, there are two crossed arrows pointing towards the center, with a small square at the end of each arrow.
worsen	The SignWriting symbol for 'worsen' features a vertical line on the left side. To its right, there are two curved arrows pointing downwards and to the right. Below these are three asterisks arranged in a slightly curved line.
worship	The SignWriting symbol for 'worship' includes a circle on the left containing two small arrows pointing towards each other. To the right of this circle is a square box with an arrow pointing downwards from its top-right corner. Below the square box is a curved arrow pointing downwards.
worship	The SignWriting symbol for 'worship' consists of a circle at the top containing two downward-pointing arrows. Below the circle is a square box with an arrow pointing downwards from its top-right corner. At the bottom is a curved arrow pointing downwards.
worship	The SignWriting symbol for 'worship' is a solid black square at the top, with a curved arrow pointing downwards below it.
worthless	The SignWriting symbol for 'worthless' shows two hands with fingers spread, one on the left and one on the right. In the center, there are two eyes with rays emanating from them, and a small asterisk below the eyes.
worthy	The SignWriting symbol for 'worthy' features two eyes with rays emanating from them at the top. Below the eyes are two curved arrows pointing downwards.
wow	The SignWriting symbol for 'wow' shows two hands with fingers spread, one on the left and one on the right. In the center, there is a circle containing a starburst or sun-like symbol. Below the circle are two curved arrows pointing downwards, and a small smiley face at the very bottom.



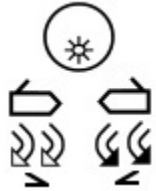
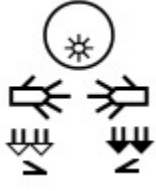



American Sign Language (ASL) Dictionary

Unedited 08082023

Spoken Word	SignWriting
WOW	
WOW	
WOW	
WOW	
WOW	
WOW	
WOW	

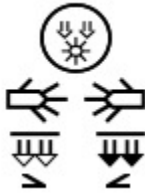
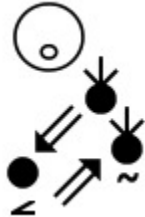
American Sign Language (ASL) Dictionary

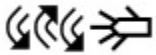
Unedited 08082023

Spoken Word	SignWriting
wow at face	
wow eyebrows down	
wow eyegaze down	
wow lexicalized	
wow!	
wow!	
wrench	









American Sign Language (ASL) Dictionary

Unedited 08082023

Spoken Word	SignWriting
wrestle	
wrestling	
wrestling	
wrist movement	
wristwatch	
write	
write	
write	
write back and forth	



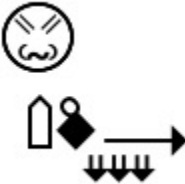





American Sign Language (ASL) Dictionary

Unedited 08082023

Spoken Word	SignWriting
write down	
write down a board	
write down easily	
write down in columns	
write down in columns	
write horizontally	
write vertical columns	
write vertical columns	



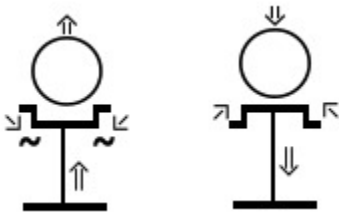





American Sign Language (ASL) Dictionary

Unedited 08082023

Spoken Word	SignWriting
write vertically	
write with a flourish	
writing	
writing	
writing	
writing	
writing chest puffing or sinking	
writing continuously	









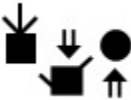

American Sign Language (ASL) Dictionary

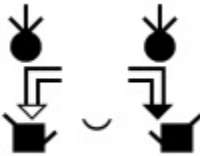
Unedited 08082023

Spoken Word	SignWriting
wrong	
wrong	
wrong	
wrong	
wrong	
wrong	
wrong continuously	
wrong suddenly	







American Sign Language (ASL) Dictionary

Unedited 08082023

Spoken Word	SignWriting
Wyoming	
Wyoming	
Wyoming	
Wyoming	
X	
X	
xerox	
Y	
Y	
Y-receptive	
Y/N expression	
yard	



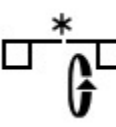
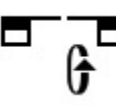

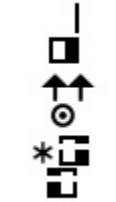

American Sign Language (ASL) Dictionary

Unedited 08082023

Spoken Word	SignWriting
yarmulke	
Yaya	
year	
year	
year	
year round	
year round	
yearbook	
yearly	









American Sign Language (ASL) Dictionary

Unedited 08082023

Spoken Word	SignWriting
yearly	
yearly	
years	
yell	
yell	
yell	
yell	

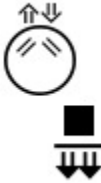

American Sign Language (ASL) Dictionary

Unedited 08082023

Spoken Word	SignWriting
yell	
yell	
yelling-repeatedly	
yellow	
yellow	
yellow	
yes	
yes	







American Sign Language (ASL) Dictionary

Unedited 08082023

Spoken Word	SignWriting
yes	
yes	

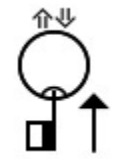
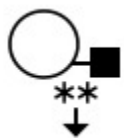

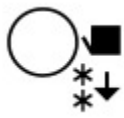

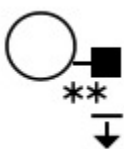

American Sign Language (ASL) Dictionary

Unedited 08082023

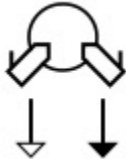
Spoken Word	SignWriting
Yes (left hand)	
yes have	
yes it is true	
yesterday	
yesterday	
yesterday	
yesterday	
yesterday	
yesterday	

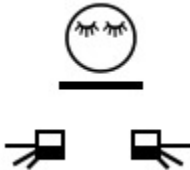
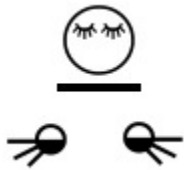

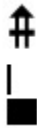



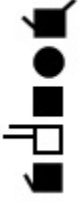

American Sign Language (ASL) Dictionary

Unedited 08082023

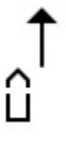
Spoken Word	SignWriting
yet	
yield - give away	
YMCA	
yoga	
yoga	
yogurt	
yonder	
yonder	







American Sign Language (ASL) Dictionary

Unedited 08082023

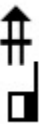
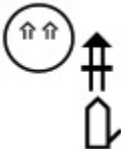
Spoken Word	SignWriting
Yosha	
You	
You	
you	
you	
you	
you	
you	



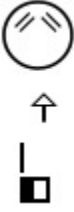





American Sign Language (ASL) Dictionary

Unedited 08082023

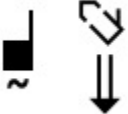
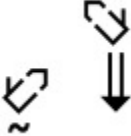
Spoken Word	SignWriting
you	
you (above)	
you (above)	
you (in front)	
you (in front)	
you - question	
you - question - left	
You all (left hand)	
You are young.	









American Sign Language (ASL) Dictionary

Unedited 08082023

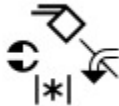
Spoken Word	SignWriting
you formal	
you formal	
you formal	
you formal	
you plural (left)	
you plural (left)	
you plural (left)	
you plural (right)	
you plural (right)	

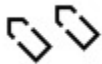





American Sign Language (ASL) Dictionary

Unedited 08082023

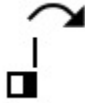
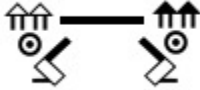
Spoken Word	SignWriting
you plural (right)	
you plural left hand	
you show me	
you-join-us	
you-left	
you-left	
you-left	
you-left	
you-plural-right	
you-to-the-left (LEFT	

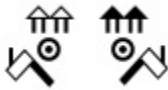
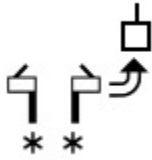





American Sign Language (ASL) Dictionary

Unedited 08082023

Spoken Word	SignWriting
you-with-me	
you_all	
young	
young	
young	
youngest	
your	
your	
your (above)	



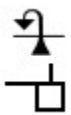

American Sign Language (ASL) Dictionary

Unedited 08082023

Spoken Word	SignWriting
your (in front)	 A vertical black bar with a small upward-pointing arrow above it.
your (in front)	 A circle containing a tilde (~) above a vertical black bar with a small upward-pointing arrow above it.
your (in front)	 A vertical black bar with a tilde (~) above it and a small upward-pointing arrow above the tilde.
your (left)	 A circle containing a tilde (~) above a vertical black bar with a small upward-pointing arrow above it. A small arrow points from the left towards the circle.
your (right)	 A circle containing a tilde (~) above a vertical black bar with a small upward-pointing arrow above it. A small arrow points from the right towards the circle.
your turn	 A vertical black bar with a small upward-pointing arrow above it. A horizontal line extends to the left from the base of the bar, and a small arrow points from the left towards the bar.
your turn	 A vertical black bar with a small upward-pointing arrow above it. A diamond shape is positioned to the left of the bar, and a small arrow points from the diamond towards the bar.
your-left-hand	 A vertical black bar with a small upward-pointing arrow above it.



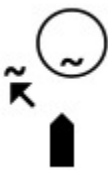
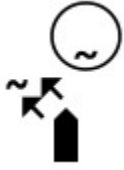
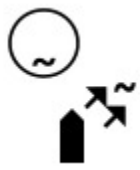

American Sign Language (ASL) Dictionary

Unedited 08082023

Spoken Word	SignWriting
your-majesty	
yours (in front)	
yours (left)	
yours (left)	
yours (right)	
yours (right)	
yours (right)	

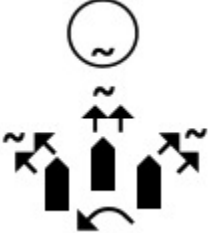

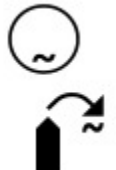
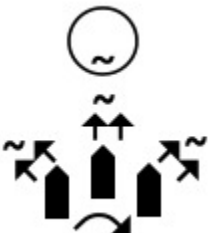
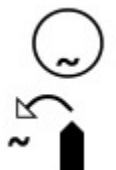
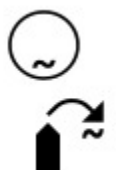



American Sign Language (ASL) Dictionary

Unedited 08082023

Spoken Word	SignWriting
yours plural (left)	 <p>The SignWriting symbol consists of a circle at the top containing a tilde (~). Below the circle are three vertical bars representing hands. The leftmost and rightmost bars have arrows pointing outwards and upwards. The middle bar has an arrow pointing upwards. A curved arrow below the middle bar indicates a counter-clockwise rotation.</p>
yours plural (left)	 <p>The SignWriting symbol consists of a circle at the top containing a tilde (~). Below the circle is a single vertical bar representing a hand with an arrow pointing upwards and to the left. A curved arrow below the bar indicates a counter-clockwise rotation.</p>
yours plural (right)	 <p>The SignWriting symbol consists of a circle at the top containing a tilde (~). Below the circle is a single vertical bar representing a hand with an arrow pointing upwards and to the right. A curved arrow below the bar indicates a clockwise rotation.</p>
yours plural (right)	 <p>The SignWriting symbol consists of a circle at the top containing a tilde (~). Below the circle are three vertical bars representing hands. The leftmost and rightmost bars have arrows pointing outwards and upwards. The middle bar has an arrow pointing upwards. A curved arrow below the middle bar indicates a counter-clockwise rotation.</p>
yours-plural-left-hand	 <p>The SignWriting symbol consists of a circle at the top containing a tilde (~). Below the circle is a single vertical bar representing a hand with an arrow pointing upwards and to the left. A curved arrow below the bar indicates a counter-clockwise rotation.</p>
yours-plural-right	 <p>The SignWriting symbol consists of a circle at the top containing a tilde (~). Below the circle is a single vertical bar representing a hand with an arrow pointing upwards and to the right. A curved arrow below the bar indicates a clockwise rotation.</p>
yours-singular	 <p>The SignWriting symbol consists of a single vertical bar representing a hand with an arrow pointing upwards.</p>



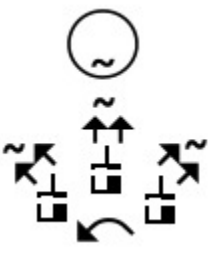



American Sign Language (ASL) Dictionary

Unedited 08082023

Spoken Word	SignWriting
yourself (in front)	 <p>The signwriting consists of a circle with a tilde (~) inside, positioned above a square with a vertical line through its center. Two arrows point upwards from the square, one on each side.</p>
yourself (left)	 <p>The signwriting consists of a circle with a tilde (~) inside, positioned above a square with a vertical line through its center. Two arrows point upwards and to the left from the square.</p>
yourself (right)	 <p>The signwriting consists of a circle with a tilde (~) inside, positioned above a square with a vertical line through its center. Two arrows point upwards and to the right from the square.</p>
yourself - left hand	 <p>The signwriting consists of a circle with a tilde (~) inside, positioned above a square with a vertical line through its center. Two arrows point upwards from the square, one on each side.</p>
yourselves (left)	 <p>The signwriting consists of a circle with a tilde (~) inside, positioned above a central square with a vertical line through its center. Two arrows point upwards and to the left from the central square. Two additional squares are positioned to the left and right of the central square, each with an arrow pointing upwards and to the left.</p>
yourselves (left)	 <p>The signwriting consists of a circle with a tilde (~) inside, positioned above a square with a vertical line through its center. Two arrows point upwards and to the left from the square.</p>
yourselves (right and left)	 <p>The signwriting consists of a central square with a vertical line through its center. Two arrows point upwards and to the right from the square. Two additional squares are positioned to the left and right of the central square, each with an arrow pointing upwards and to the left.</p>

American Sign Language (ASL) Dictionary

Unedited 08082023

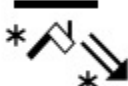
Spoken Word	SignWriting
yourselves (right)	
yourselves (right)	
yourselves - left hand	
youth	
YouTube	
yuck	
Yugoslavia	
Yugoslavia	









American Sign Language (ASL) Dictionary

Unedited 08082023

Spoken Word	SignWriting
Yugoslavian	The SignWriting symbol for 'Yugoslavian' consists of a horizontal bar at the top. Below it is a diamond shape with an arrow pointing down and to the right. This is followed by an asterisk, then another arrow pointing down and to the right, and finally another asterisk.









American Sign Language (ASL) Dictionary

Unedited 08082023

Spoken Word	SignWriting
Z	
Z - left hand	
Z-expressive-left hand	
Z-motion	
Z-right hand receptive	
zebra	
zebra	
zebra2	
zero	

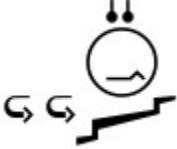

American Sign Language (ASL) Dictionary

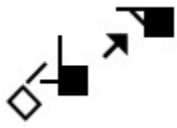
Unedited 08082023

Spoken Word	SignWriting
zero	
zero	
zero	
zero	
zero	
zipper	
zombie	
ZOO	
ZOO	
ZOOM	

American Sign Language (ASL) Dictionary

Unedited 08082023

Spoken Word	SignWriting
???????	
???????	
???????	